

YASKAWA

MOTOMAN AR700

Arc Welding with the AR-series

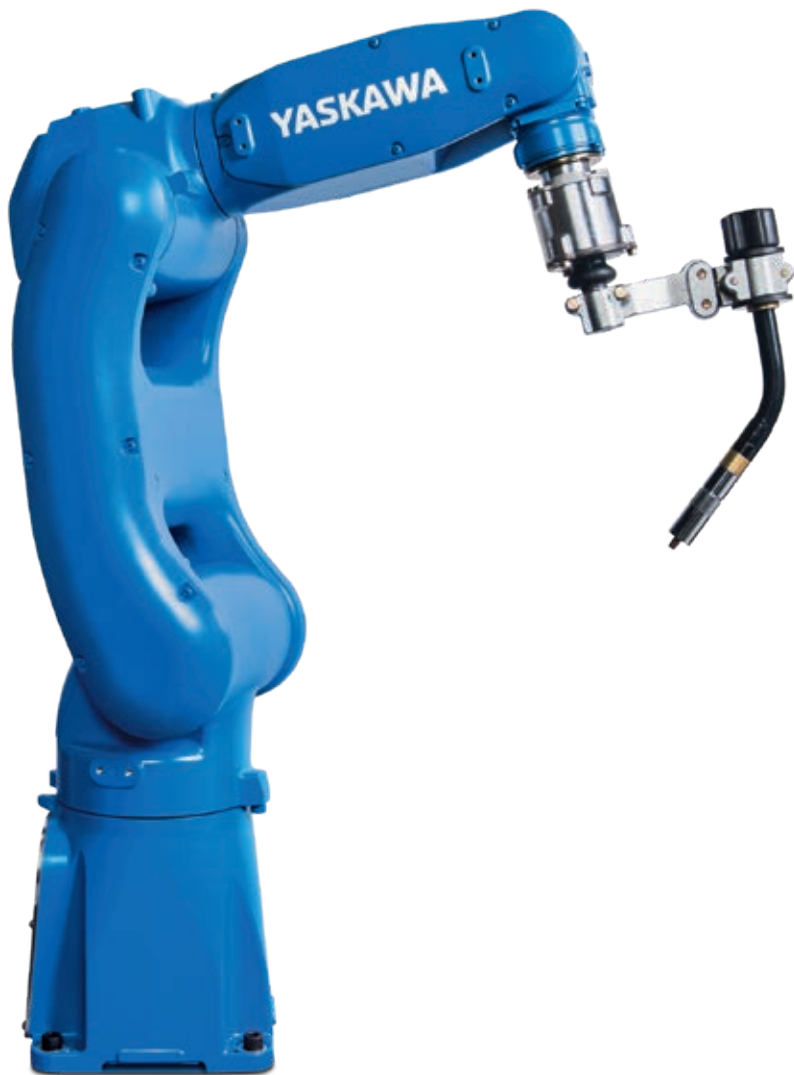

The MOTOMAN AR700 is a compact high-speed 6-axis robot which provides accurate performance to achieve optimal results in extremely difficult conditions and especially for the high demands of arc welding applications.

With a payload of up to 8 kg and a working range of 700 mm, this robot enables welding of a broad variety of small workpieces with high quality results. The applicable inertia and axis speeds have been significantly raised, which leads to a “best in class” performance, speed and acceleration.

The slim, straight and symmetrical arm design minimizes interference with peripherals even in small workspaces. The MOTOMAN AR700 is easy to clean and well protected (by protection class IP67) against dust or coolants. Cable routing is possible from the side of the robot socket or from the bottom through the base plate (option). This enables an easy and space-saving integration into its environment.

KEY BENEFITS

- Compact, fast and accurate
- High acceleration
- Protection class IP67
- Less interferences due to optimized design
- Simple integration, installation and maintenance

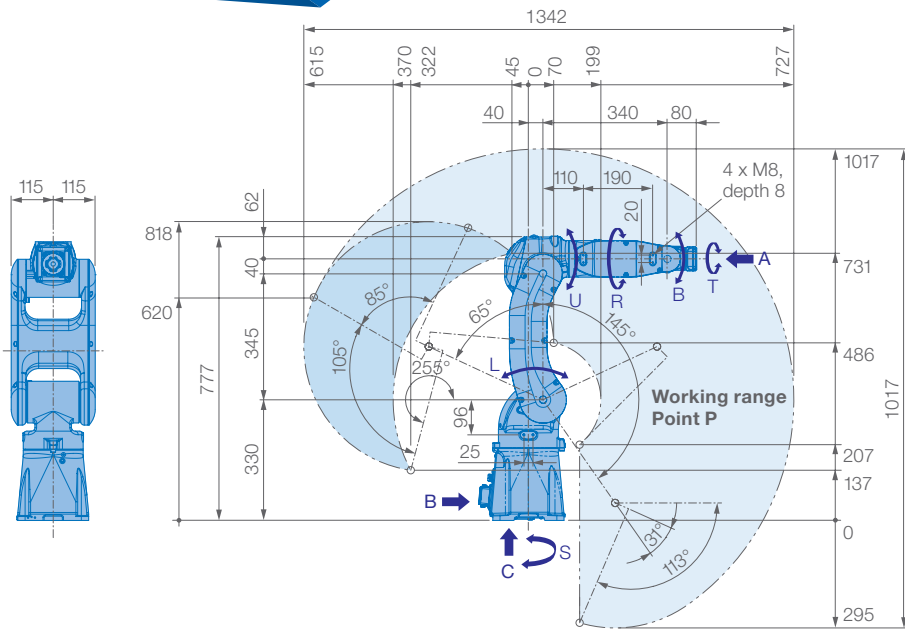

View A

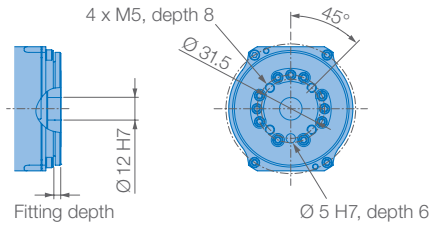

View B

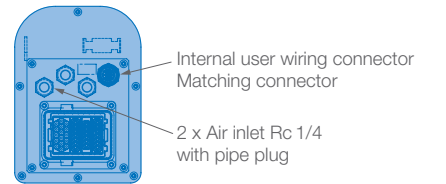

View C

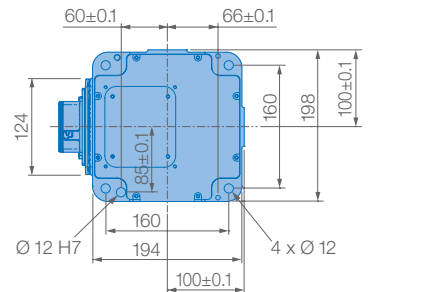

Mounting options: Floor, ceiling, wall, tilt*
IP Protection: IP67

* tilt with condition of angle – see table below

Robot installation angle θ [deg.]	S-axis operating range [deg.]
$0 \leq \theta \leq 30$	± 170 degrees or less (no limit)
$30 < \theta \leq 35$	± 60 degrees or less
$35 < \theta \leq 45$	± 45 degrees or less
$45 < \theta$	± 30 degrees or less

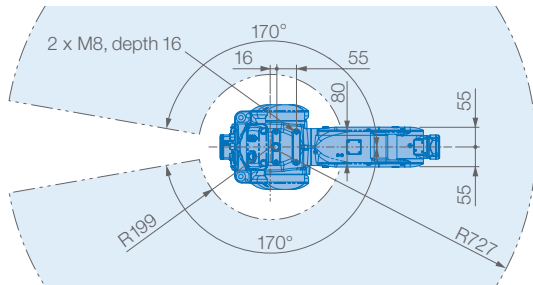

Allowable wrist load

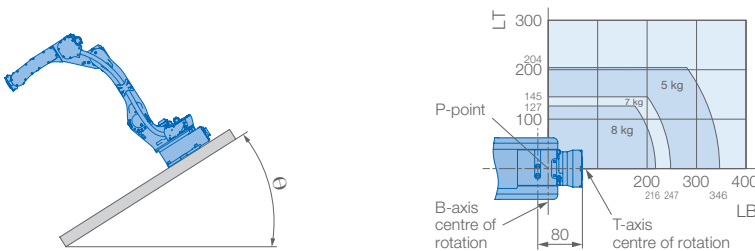

Specifications AR700					
Axes	Maximum motion range [°]	Maximum speed [°/s]	Allowable moment [Nm]	Allowable moment of inertia [kg · m ²]	Controlled axes
S	± 170	455	–	–	6
L	+145/–65	385	–	–	Max. payload [kg]
U	+190/–70	520	–	–	Repeatability [mm]
R	± 190	550	17	0.5	Max. working range R [mm]
B	± 135	550	17	0.5	Temperature [°C]
T	± 360	1000	10	0.2	Humidity [%]
					Weight [kg]
					Power supply, average [kVA]

* Conforms to ISO 9283 ** Varies in accordance with applications and motion patterns

Yaskawa Europe GmbH

Robotics Division
Yaskawastraße 1
85391 Allershausen
Germany

Tel. +49 (0) 8166 90-0
robotics@yaskawa.eu.com
www.yaskawa.eu.com

YR-1-06VX8-A00
B-04-2021, A-No. 207071