

VIPA System 200V

FM | Manual

HB97E_FM | RE_253-1BA00 | Rev. 14/46

November 2014

Copyright © VIPA GmbH. All Rights Reserved.

This document contains proprietary information of VIPA and is not to be disclosed or used except in accordance with applicable agreements.

This material is protected by the copyright laws. It may not be reproduced, distributed, or altered in any fashion by any entity (either internal or external to VIPA), except in accordance with applicable agreements, contracts or licensing, without the express written consent of VIPA and the business management owner of the material.

For permission to reproduce or distribute, please contact:
VIPA, Gesellschaft für Visualisierung und Prozessautomatisierung mbH
Ohmstraße 4, D-91074 Herzogenaurach, Germany
Tel.: +49 (91 32) 744 -0
Fax.: +49 9132 744 1864
EMail: info@vipa.de
<http://www.vipa.com>

Note

Every effort has been made to ensure that the information contained in this document was complete and accurate at the time of publishing. Nevertheless, the authors retain the right to modify the information. This customer document describes all the hardware units and functions known at the present time. Descriptions may be included for units which are not present at the customer site. The exact scope of delivery is described in the respective purchase contract.

CE Conformity Declaration

Hereby, VIPA GmbH declares that the products and systems are in compliance with the essential requirements and other relevant provisions.

Conformity is indicated by the CE marking affixed to the product.

Conformity Information

For more information regarding CE marking and Declaration of Conformity (DoC), please contact your local VIPA customer service organization.

Trademarks

VIPA, SLIO, System 100V, System 200V, System 300V, System 300S, System 400V, System 500S and Commander Compact are registered trademarks of VIPA Gesellschaft für Visualisierung und Prozessautomatisierung mbH.

SPEED7 is a registered trademark of profichip GmbH.

SIMATIC, STEP, SINEC, TIA Portal, S7-300 and S7-400 are registered trademarks of Siemens AG.

Microsoft und Windows are registered trademarks of Microsoft Inc., USA.

Portable Document Format (PDF) and Postscript are registered trademarks of Adobe Systems, Inc.

All other trademarks, logos and service or product marks specified herein are owned by their respective companies.

Information product support

Contact your local VIPA Customer Service Organization representative if you wish to report errors or questions regarding the contents of this document. If you are unable to locate a customer service center, contact VIPA as follows:

VIPA GmbH, Ohmstraße 4, 91074 Herzogenaurach, Germany

Telefax: +49 9132 744 1204
EMail: documentation@vipa.de

Technical support

Contact your local VIPA Customer Service Organization representative if you encounter problems with the product or have questions regarding the product. If you are unable to locate a customer service center, contact VIPA as follows:

VIPA GmbH, Ohmstraße 4, 91074 Herzogenaurach, Germany

Telephone: +49 9132 744 1150 (Hotline)
EMail: support@vipa.de

Contents

About this manual	1
Safety information	2
Chapter 1 Basics and Assembly	1-1
Safety Information for Users.....	1-2
System conception	1-3
Dimensions	1-5
Installation	1-7
Demounting and module exchange	1-11
Wiring.....	1-12
Installation guidelines	1-14
General data	1-17
Chapter 2 Hardware description	2-1
Properties.....	2-2
Structure	2-3
Connecting a drive	2-6
Technical data.....	2-7
Chapter 3 Deployment	3-1
Data transfer CPU >> FM 253.....	3-2
Parameterization	3-3
Operating modes.....	3-5
Data transfer FM 253 >> CPU.....	3-10
Handling blocks.....	3-12

About this manual

This manual describes the System 200V MotionControl Stepper module FM 253 from VIPA. Here you may find every information for commissioning and operation.

Overview

Chapter 1: Basics and Assembly

The focus of this chapter is on the introduction of the VIPA System 200V. Here you will find the information required to assemble and wire a controller system consisting of System 200V components.

Besides the dimensions the general technical data of System 200V will be found.

Chapter 2: Hardware description

Here the hardware components of the FM 253-1BA00 are described.

The technical data are at the end of the chapter.

Chapter 3: Deployment

This chapter contains information about the data transfer and the operating modes of the MotionControl Stepper module FM 253 for stepper motors.

Objective and contents

This manual describes the System 200V MotionControl Stepper module FM 253 from VIPA. It contains a description of the construction, project implementation and usage.

This manual is part of the documentation package with order number HB97E_FM and relevant for:

Product	Order number	as of state: HW
FM 253	VIPA 253-1BA00	01

Target audience

The manual is targeted at users who have a background in automation technology.

Structure of the manual

The manual consists of chapters. Every chapter provides a self-contained description of a specific topic.

Guide to the document

The following guides are available in the manual:

- an overall table of contents at the beginning of the manual
- an overview of the topics for every chapter

Availability

The manual is available in:

- printed form, on paper
- in electronic form as PDF-file (Adobe Acrobat Reader)

Icons Headings

Important passages in the text are highlighted by following icons and headings:

**Danger!**

Immediate or likely danger.
Personal injury is possible.

**Attention!**

Damages to property is likely if these warnings are not heeded.

**Note!**

Supplementary information and useful tips.

Safety information

Applications conforming with specifications

The FM 253 is constructed and produced for:

- all VIPA System 200V components
- communication and process control
- general control and automation applications
- industrial applications
- operation within the environmental conditions specified in the technical data
- installation into a cubicle



Danger!

This device is not certified for applications in

- in explosive environments (EX-zone)

Documentation

The manual must be available to all personnel in the

- project design department
- installation department
- commissioning
- operation



The following conditions must be met before using or commissioning the components described in this manual:

- Hardware modifications to the process control system should only be carried out when the system has been disconnected from power!
- Installation and hardware modification only by properly trained personnel.
- The national rules and regulations of the respective country must be satisfied (installation, safety, EMC ...)

Disposal

National rules and regulations apply to the disposal of the unit!

Chapter 1 Basics and Assembly

Overview

The focus of this chapter is on the introduction of the VIPA System 200V. Here you will find the information required to assemble and wire a controller system consisting of System 200V components. Besides the dimensions the general technical data of System 200V will be found.

Contents

Topic	Page
Chapter 1 Basics and Assembly	1-1
Safety Information for Users	1-2
System conception	1-3
Dimensions	1-5
Installation	1-7
Demounting and module exchange	1-11
Wiring	1-12
Installation guidelines	1-14
General data	1-17

Safety Information for Users

Handling of electrostatic sensitive modules

VIPA modules make use of highly integrated components in MOS-Technology. These components are extremely sensitive to over-voltages that can occur during electrostatic discharges.

The following symbol is attached to modules that can be destroyed by electrostatic discharges.



The Symbol is located on the module, the module rack or on packing material and it indicates the presence of electrostatic sensitive equipment.

It is possible that electrostatic sensitive equipment is destroyed by energies and voltages that are far less than the human threshold of perception. These voltages can occur where persons do not discharge themselves before handling electrostatic sensitive modules and they can damage components thereby, causing the module to become inoperable or unusable.

Modules that have been damaged by electrostatic discharges can fail after a temperature change, mechanical shock or changes in the electrical load.

Only the consequent implementation of protection devices and meticulous attention to the applicable rules and regulations for handling the respective equipment can prevent failures of electrostatic sensitive modules.

Shipping of electrostatic sensitive modules

Modules must be shipped in the original packing material.

Measurements and alterations on electrostatic sensitive modules

When you are conducting measurements on electrostatic sensitive modules you should take the following precautions:

- Floating instruments must be discharged before use.
- Instruments must be grounded.

Modifying electrostatic sensitive modules you should only use soldering irons with grounded tips.



Attention!

Personnel and instruments should be grounded when working on electrostatic sensitive modules.

System conception

Overview

The System 200V is a modular automation system for assembly on a 35mm profile rail. By means of the peripheral modules with 4, 8 and 16 channels this system may properly be adapted matching to your automation tasks.

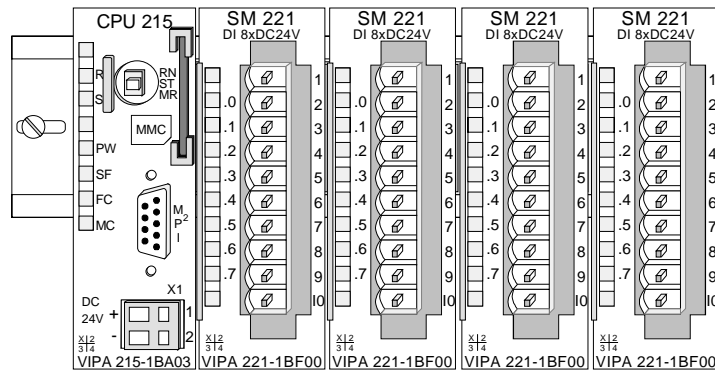

Components

The System 200V consists of the following components:

- Head modules like CPU and bus coupler
- Periphery modules like I/O, function und communication modules
- Power supplies
- Extension modules

Head modules

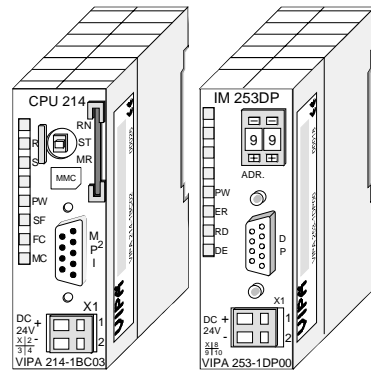

With a head module CPU respectively bus interface and DC 24V power supply are integrated to one casing.

Via the integrated power supply the CPU respectively bus interface is power supplied as well as the electronic of the connected periphery modules.

Periphery modules

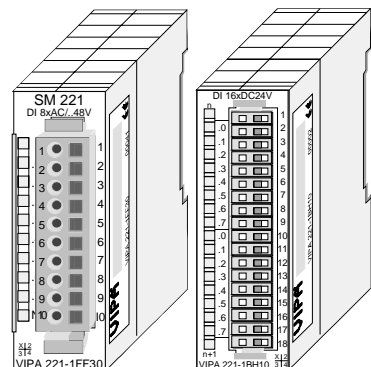

The modules are direct installed on a 35mm profile rail and connected to the head module by a bus connector, which was mounted on the profile rail before.

Most of the periphery modules are equipped with a 10pin respectively 18pin connector. This connector provides the electrical interface for the signaling and supplies lines of the modules.

Power supplies

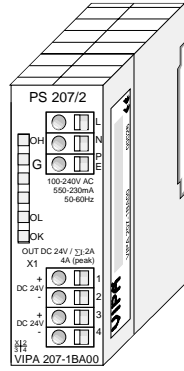

With the System 200V the DC 24V power supply can take place either externally or via a particularly for this developed power supply.

The power supply may be mounted on the profile rail together with the System 200V modules. It has no connector to the backplane bus.

Expansion modules

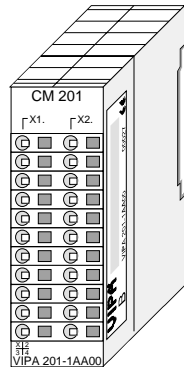

The expansion modules are complementary modules providing 2- or 3wire connection facilities.

The modules are not connected to the backplane bus.

Structure/ dimensions

- Profile rail 35mm
- Dimensions of the basic enclosure:
 - 1tier width: (HxWxD) in mm: 76x25.4x74 in inches: 3x1x3
 - 2tier width: (HxWxD) in mm: 76x50.8x74 in inches: 3x2x3

Installation

Please note that you can only install head modules, like the CPU, the PC and couplers at slot 1 or 1 and 2 (for double width modules).

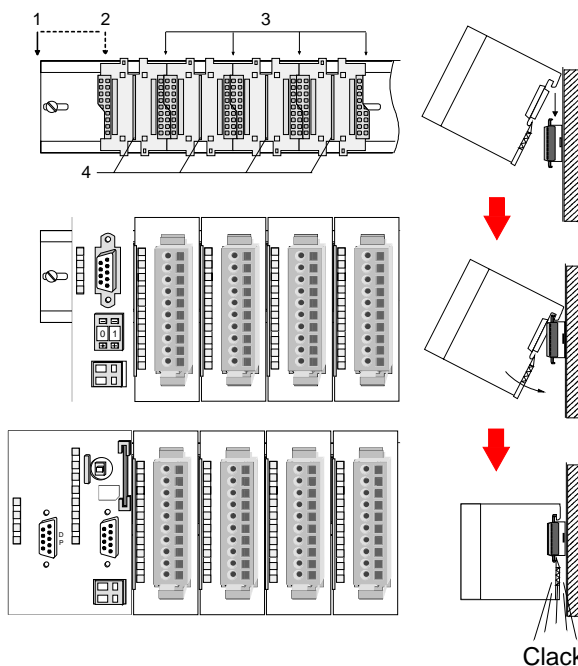

[1]	Head module (double width)
[2]	Head module (single width)
[3]	Periphery module
[4]	Guide rails

Note

Information about the max. number of pluggable modules and the max. current at the backplane bus can be found in the "Technical Data" of the according head module.

Please install modules with a high current consumption directly beside the head module.

Dimensions

Dimensions 1tier width (HxWxD) in mm: 76 x 25.4 x 74
Basic enclosure 2tier width (HxWxD) in mm: 76 x 50.8 x 74

Installation dimensions

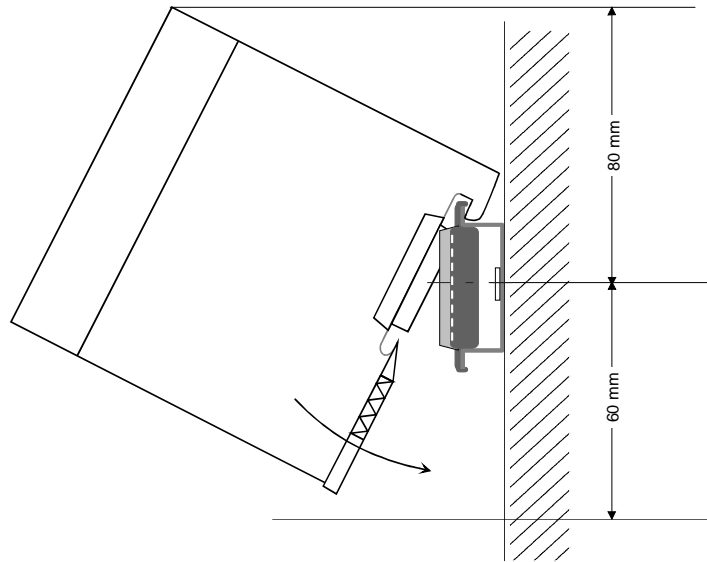

Installed and wired dimensions

In- / Output modules

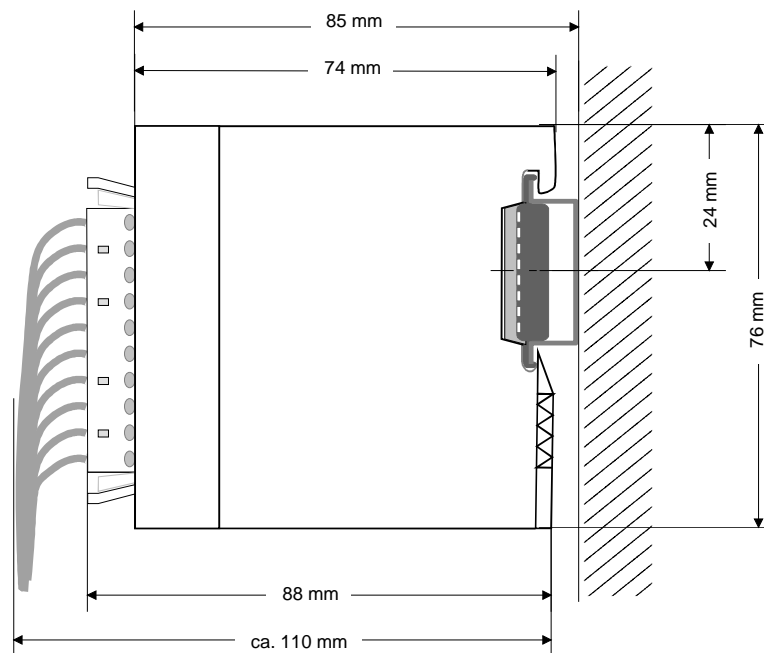

Function modules/
Extension modules

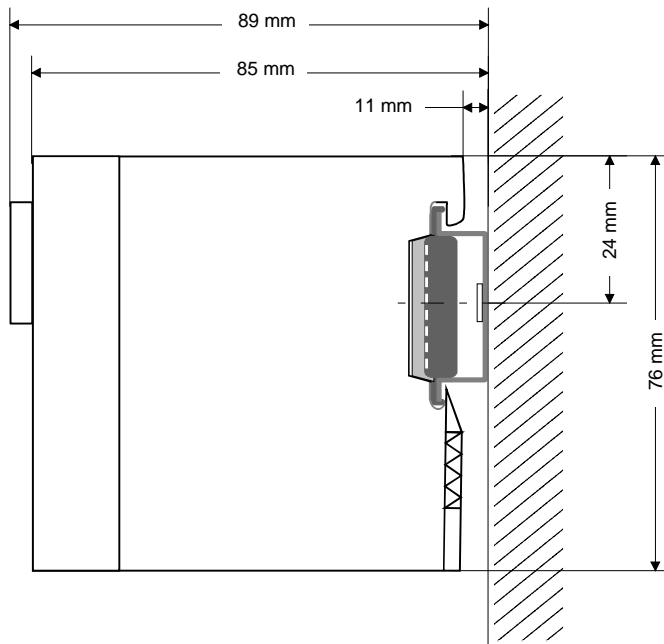

CPUs (here with
EasyConn from
VIPA)

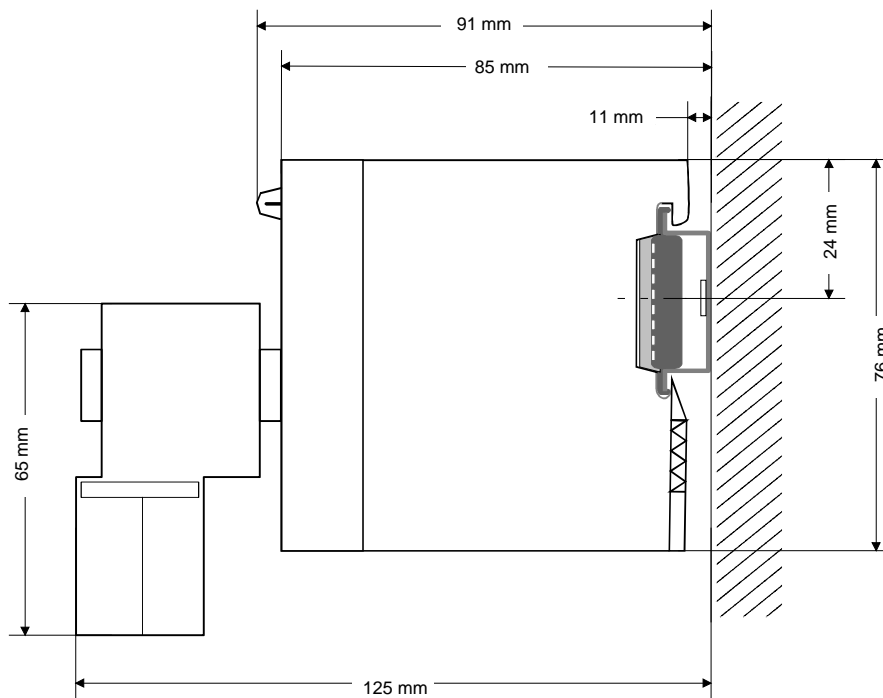

Installation

General

The modules are each installed on a 35mm profile rail and connected via a bus connector. Before installing the module the bus connector is to be placed on the profile rail before.

Profile rail

For installation the following 35mm profile rails may be used:

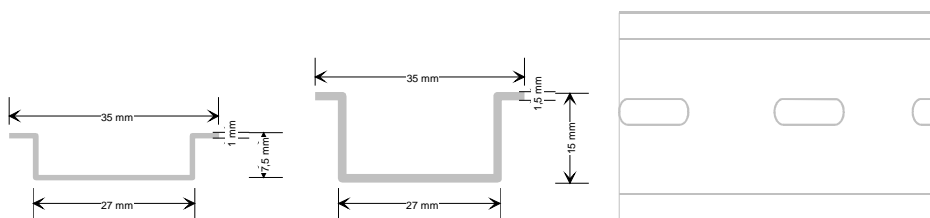

Order number	Label	Description
290-1AF00	35mm profile rail	Length 2000mm, height 15mm
290-1AF30	35mm profile rail	Length 530mm, height 15mm

Bus connector

System 200V modules communicate via a backplane bus connector. The backplane bus connector is isolated and available from VIPA in of 1-, 2-, 4- or 8tier width.

The following figure shows a 1tier connector and a 4tier connector bus:

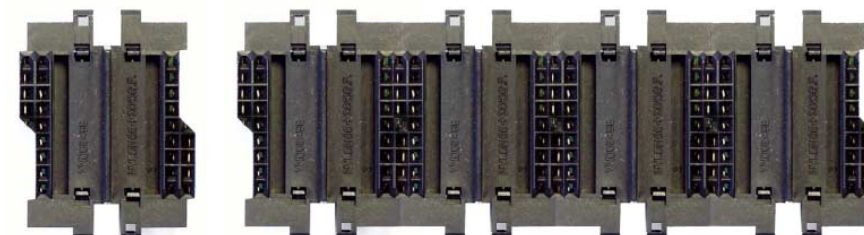

The bus connector is to be placed on the profile rail until it clips in its place and the bus connections look out from the profile rail.

Order number	Label	Description
290-0AA10	Bus connector	1tier
290-0AA20	Bus connector	2tier
290-0AA40	Bus connector	4tier
290-0AA80	Bus connector	8tier

Installation on a profile rail

The following figure shows the installation of a 4tier width bus connector in a profile rail and the slots for the modules.

The different slots are defined by guide rails.

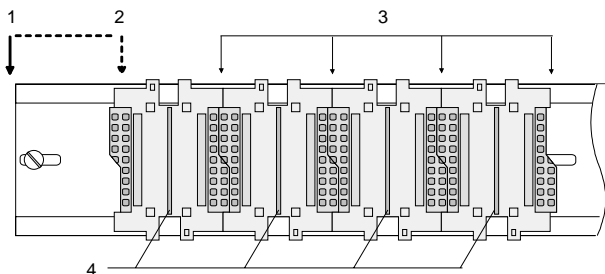

- [1] Head module (double width)
- [2] Head module (single width)
- [3] Peripheral module
- [4] Guide rails

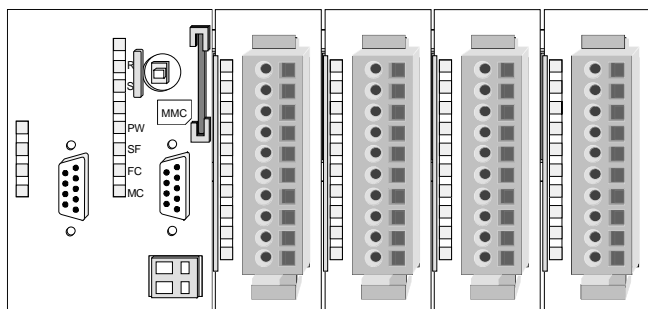
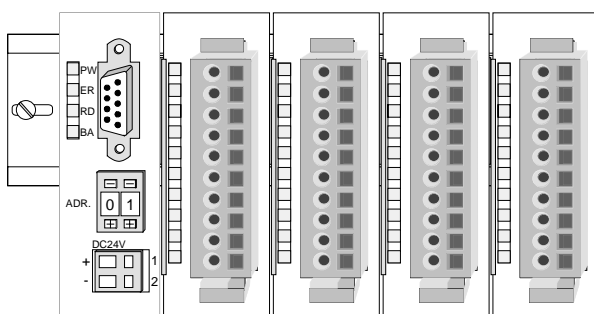

Assembly regarding the current consumption

- Use bus connectors as long as possible.
- Sort the modules with a high current consumption right beside the head module. In the service area of www.vipa.com a list of current consumption of every System 200V module can be found.

Assembly possibilities

horizontal assembly

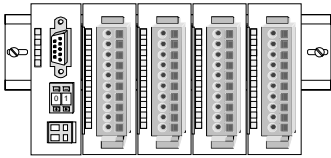

vertical assembly

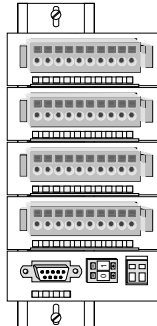

lying assembly

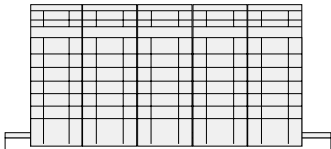

Please regard the allowed environmental temperatures:

- horizontal assembly: from 0 to 60°C
- vertical assembly: from 0 to 40°C
- lying assembly: from 0 to 40°C

The horizontal assembly always starts at the left side with a head module, then you install the peripheral modules beside to the right.

You may install up to 32 peripheral modules.

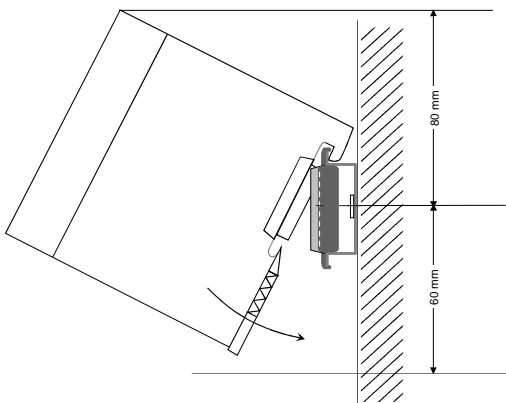

Please follow these rules during the assembly!

- Turn off the power supply before you install or remove any modules!
- Make sure that a clearance of at least 60mm exists above and 80mm below the middle of the profile rail.

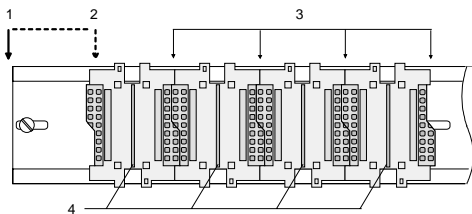

- Every row must be completed from left to right and it has to start with a head module.

- [1] Head module (double width)
- [2] Head module (single width)
- [3] Peripheral modules
- [4] Guide rails

- Modules are to be installed side by side. Gaps are not permitted between the modules since this would interrupt the backplane bus.
- A module is only installed properly and connected electrically when it has clicked into place with an audible click.
- Slots after the last module may remain unoccupied.



Note!

Information about the max. number of pluggable modules and the max. current at the backplane bus can be found in the "Technical Data" of the according head module.

Please install modules with a high current consumption directly beside the head module.

Assembly procedure

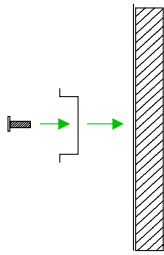

- Install the profile rail. Make sure that a clearance of at least 60mm exists above and 80mm below the middle of the profile rail.

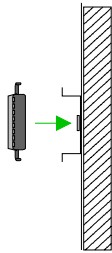

- Press the bus connector into the profile rail until it clips securely into place and the bus-connectors look out from the profile rail. This provides the basis for the installation of your modules.

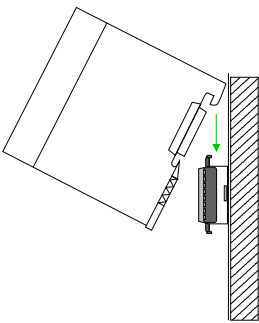

- Start at the outer left location with the installation of your head module and install the peripheral modules to the right of this.

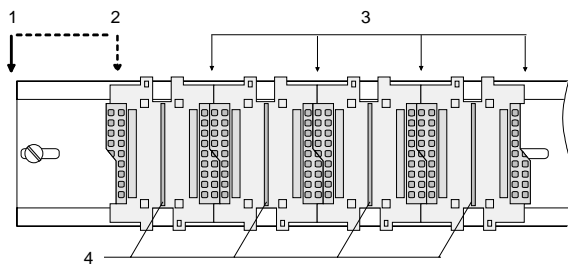

- [1] Head module (double width)
- [2] Head module (single width)
- [3] Peripheral module
- [4] Guide rails

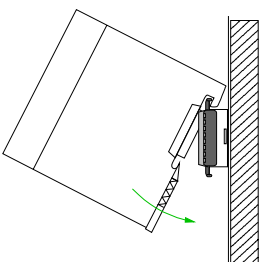

- Insert the module that you are installing into the profile rail at an angle of 45 degrees from the top and rotate the module into place until it clicks into the profile rail with an audible click. The proper connection to the backplane bus can only be guaranteed when the module has properly clicked into place.



Attention!

Power must be turned off before modules are installed or removed!

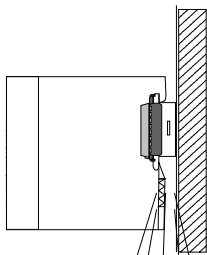

Clack

Demounting and module exchange

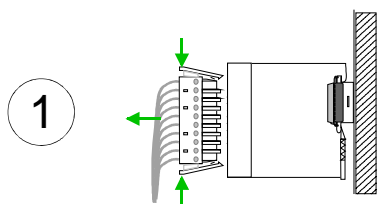

- Remove if exists the wiring to the module, by pressing both locking lever on the connector and pulling the connector.

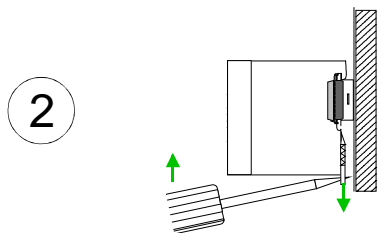

- The casing of the module has a spring loaded clip at the bottom by which the module can be removed.

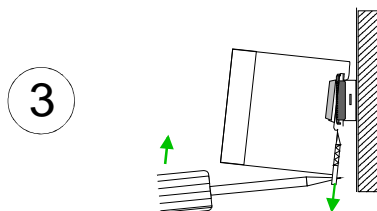

- The clip is unlocked by pressing the screwdriver in an upward direction.

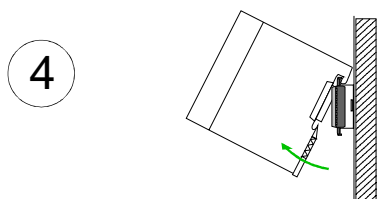

- Withdraw the module with a slight rotation to the top.

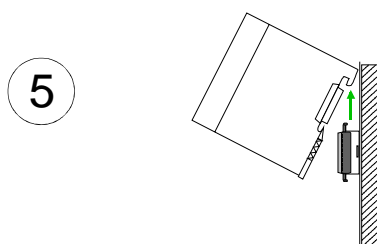

Attention!

Power must be turned off before modules are installed or removed!

Please regard that the backplane bus is interrupted at the point where the module was removed!

Wiring

Overview

Most peripheral modules are equipped with a 10pole or a 18pole connector. This connector provides the electrical interface for the signaling and supply lines of the modules.

The modules carry spring-clip connectors for interconnections and wiring.

The spring-clip connector technology simplifies the wiring requirements for signaling and power cables.

In contrast to screw terminal connections, spring-clip wiring is vibration proof. The assignment of the terminals is contained in the description of the respective modules.

You may connect conductors with a diameter from 0.08mm² up to 2.5mm² (max. 1.5mm² for 18pole connectors).

The following figure shows a module with a 10pole connector.

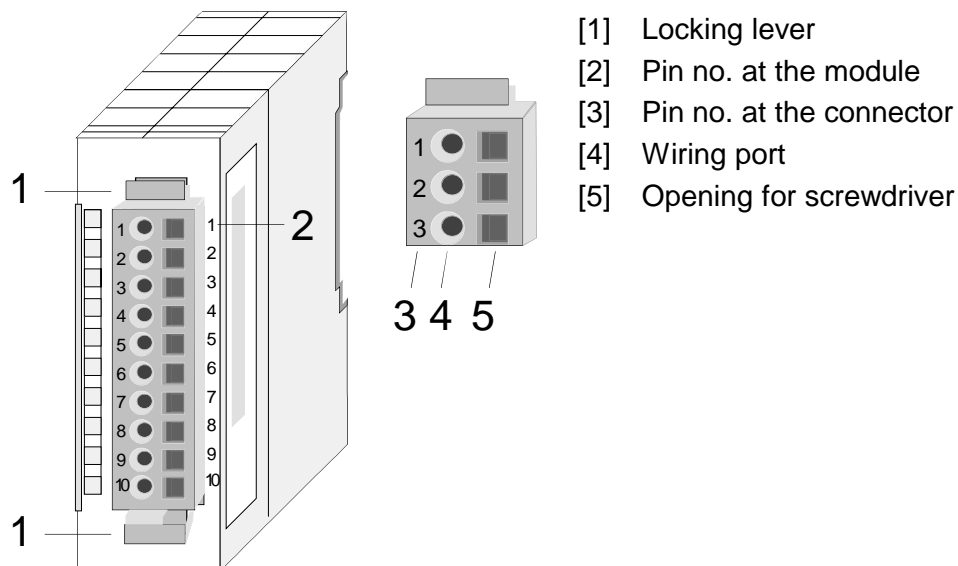

Note!

The spring-clip is destroyed if you push the screwdriver into the wire port! Make sure that you only insert the screwdriver into the square hole of the connector!

Wiring procedure

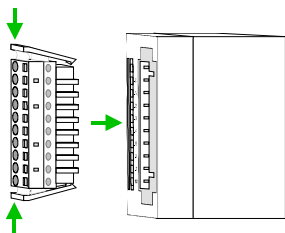

- Install the connector on the module until it locks with an audible click. For this purpose you press the two clips together as shown. The connector is now in a permanent position and can easily be wired.

The following section shows the wiring procedure from top view.

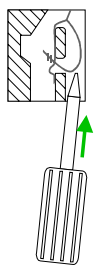

- Insert a screwdriver at an angle into the square opening as shown.
- Press and hold the screwdriver in the opposite direction to open the contact spring.

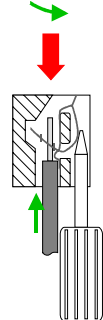

- Insert the stripped end of the wire into the round opening. You can use wires with a diameter of 0.08mm² to 2.5mm² (1.5mm² for 18pole connectors).

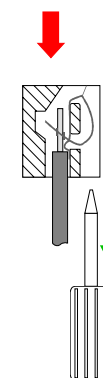

- By removing the screwdriver the wire is connected safely with the plug connector via a spring.



Note!

Wire the power supply connections first followed by the signal cables (inputs and outputs).

Installation guidelines

General The installation guidelines contain information about the interference free deployment of System 200V systems. There is the description of the ways, interference may occur in your control, how you can make sure the electromagnetic digestibility (EMC), and how you manage the isolation.

What means EMC? Electromagnetic digestibility (EMC) means the ability of an electrical device, to function error free in an electromagnetic environment without being interferenced res. without interfering the environment.
All System 200V components are developed for the deployment in hard industrial environments and fulfill high demands on the EMC. Nevertheless you should project an EMC planning before installing the components and take conceivable interference causes into account.

Possible interference causes Electromagnetic interferences may interfere your control via different ways:

- Fields
- I/O signal conductors
- Bus system
- Current supply
- Protected earth conductor

Depending on the spreading medium (lead bound or lead free) and the distance to the interference cause, interferences to your control occur by means of different coupling mechanisms.

One differs:

- galvanic coupling
- capacitive coupling
- inductive coupling
- radiant coupling

Basic rules for EMC

In the most times it is enough to take care of some elementary rules to guarantee the EMC. Please regard the following basic rules when installing your PLC.

- Take care of a correct area-wide grounding of the inactive metal parts when installing your components.
 - Install a central connection between the ground and the protected earth conductor system.
 - Connect all inactive metal extensive and impedance-low.
 - Please try not to use aluminum parts. Aluminum is easily oxidizing and is therefore less suitable for grounding.
- When cabling, take care of the correct line routing.
 - Organize your cabling in line groups (high voltage, current supply, signal and data lines).
 - Always lay your high voltage lines and signal res. data lines in separate channels or bundles.
 - Route the signal and data lines as near as possible beside ground areas (e.g. suspension bars, metal rails, tin cabinet).
- Proof the correct fixing of the lead isolation.
 - Data lines must be laid isolated.
 - Analog lines must be laid isolated. When transmitting signals with small amplitudes the one sided laying of the isolation may be favorable.
 - Lay the line isolation extensively on an isolation/protected earth conductor rail directly after the cabinet entry and fix the isolation with cable clamps.
 - Make sure that the isolation/protected earth conductor rail is connected impedance-low with the cabinet.
 - Use metallic or metalized plug cases for isolated data lines.
- In special use cases you should appoint special EMC actions.
 - Wire all inductivities with erase links.
 - Please consider luminescent lamps can influence signal lines.
- Create a homogeneous reference potential and ground all electrical operating supplies when possible.
 - Please take care for the targeted employment of the grounding actions. The grounding of the PLC is a protection and functionality activity.
 - Connect installation parts and cabinets with the System 200V in star topology with the isolation/protected earth conductor system. So you avoid ground loops.
 - If potential differences between installation parts and cabinets occur, lay sufficiently dimensioned potential compensation lines.

Isolation of conductors

Electrical, magnetically and electromagnetic interference fields are weakened by means of an isolation, one talks of absorption.

Via the isolation rail, that is connected conductive with the rack, interference currents are shunt via cable isolation to the ground. Hereby you have to make sure, that the connection to the protected earth conductor is impedance-low, because otherwise the interference currents may appear as interference cause.

When isolating cables you have to regard the following:

- If possible, use only cables with isolation tangle.
- The hiding power of the isolation should be higher than 80%.
- Normally you should always lay the isolation of cables on both sides. Only by means of the both-sided connection of the isolation you achieve high quality interference suppression in the higher frequency area.
Only as exception you may also lay the isolation one-sided. Then you only achieve the absorption of the lower frequencies. A one-sided isolation connection may be convenient, if:
 - the conduction of a potential compensating line is not possible
 - analog signals (some mV res. μ A) are transferred
 - foil isolations (static isolations) are used.
- With data lines always use metallic or metalized plugs for serial couplings. Fix the isolation of the data line at the plug rack. Do not lay the isolation on the PIN 1 of the plug bar!
- At stationary operation it is convenient to strip the insulated cable interruption free and lay it on the isolation/protected earth conductor line.
- To fix the isolation tangles use cable clamps out of metal. The clamps must clasp the isolation extensively and have well contact.
- Lay the isolation on an isolation rail directly after the entry of the cable in the cabinet. Lead the isolation further on to the System 200V module and **don't** lay it on there again!

**Please regard at installation!**

At potential differences between the grounding points, there may be a compensation current via the isolation connected at both sides.

Remedy: Potential compensation line.

General data

Structure/ dimensions

- Profile rail 35mm
- Peripheral modules with recessed labelling
- Dimensions of the basic enclosure:
1tier width: (HxWxD) in mm: 76x25.4x74 in inches: 3x1x3
2tier width: (HxWxD) in mm: 76x50.8x74 in inches: 3x2x3

Reliability

- Wiring by means of spring pressure connections (CageClamps) at the front-facing connector, core cross-section 0.08 ... 2.5mm² or 1.5mm² (18pole plug)
- Complete isolation of the wiring when modules are exchanged
- Every module is isolated from the backplane bus

General data

Conformity and approval		
Conformity		
CE	2006/95/EC	Low-voltage directive
	2004/108/EC	EMC directive
Approval		
UL	UL 508	Approval for USA and Canada
others		
RoHS	2011/65/EU	Product is lead-free; Restriction of the use of certain hazardous substances in electrical and electronic equipment

Protection of persons and device protection		
Type of protection	-	IP20
Electrical isolation		
to the field bus	-	electrically isolated
to the process level	-	electrically isolated
Insulation resistance	EN 61131-2	-
Insulation voltage to reference earth		
Inputs / outputs	-	AC / DC 50V, test voltage AC 500V
Protective measures	-	against short circuit

Environmental conditions to EN 61131-2		
Climatic		
Storage / transport	EN 60068-2-14	-25...+70°C
Operation		
Horizontal installation	EN 61131-2	0...+60°C
Vertical installation	EN 61131-2	0...+60°C
Air humidity	EN 60068-2-30	RH1 (without condensation, rel. humidity 10...95%)
Pollution	EN 61131-2	Degree of pollution 2
Mechanical		
Oscillation	EN 60068-2-6	1g, 9Hz ... 150Hz
Shock	EN 60068-2-27	15g, 11ms

Mounting conditions		
Mounting place	-	In the control cabinet
Mounting position	-	Horizontal and vertical

EMC	Standard	Comment
Emitted interference	EN 61000-6-4	Class A (Industrial area)
Noise immunity zone B	EN 61000-6-2	Industrial area
	EN 61000-4-2	ESD 8kV at air discharge (degree of severity 3), 4kV at contact discharge (degree of severity 2)
	EN 61000-4-3	HF field immunity (casing) 80MHz ... 1000MHz, 10V/m, 80% AM (1kHz) 1.4GHz ... 2.0GHz, 3V/m, 80% AM (1kHz) 2GHz ... 2.7GHz, 1V/m, 80% AM (1kHz)
	EN 61000-4-6	HF conducted 150kHz ... 80MHz, 10V, 80% AM (1kHz)
	EN 61000-4-4	Burst, degree of severity 3
	EN 61000-4-5	Surge, installation class 3 *)

*) Due to the high-energetic single pulses with Surge an appropriate external protective circuit with lightning protection elements like conductors for lightning and overvoltage is necessary.

Chapter 2 Hardware description

Overview Here the hardware components of the FM 253-1BA00 are described.
The technical data are at the end of the chapter.

Contents	Topic	Page
	Chapter 2 Hardware description.....	2-1
	Properties.....	2-2
	Structure	2-3
	Connecting a drive	2-6
	Technical data.....	2-7

Properties

FM 253 253-1BA00

The FM 253 is a positioning module for controlling a stepper motor. The modules may be used for point-to-point positioning as well as for complex drive outlines with need for a high level of precision, dynamics and speed. Stepper motors are employed where a maximum torque at low rotational speed is required and the target position shall be reached and held without overshoot.

The module works independently and is controlled via an according user application at the CPU.

The module has the following characteristics:

- Microprocessor controlled positioning module for controlling a 1axis drive with stepper motor.
- Operating round and linear axis
- Different operating modes
- The parameterization data is stored in the internal Flash memory. There is no battery required.
- The module contains 3 inputs for connecting end switches and is able to control 2 outputs.

The states of the in-/outputs are additionally shown via LEDs.

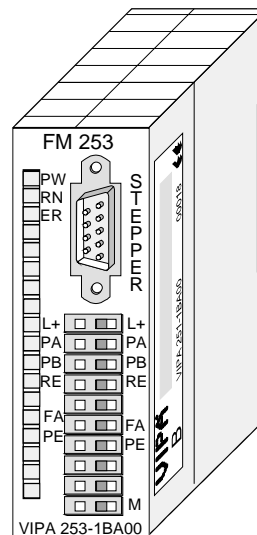

Order data

Type	Order number	Description
FM 253	VIPA 253-1BA00	MotionControl Module Stepper

Structure

Front view

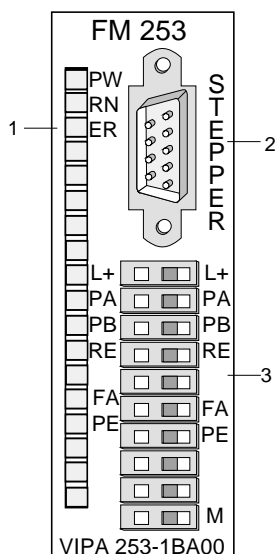

- [1] LED Status monitor
- [2] Plug for drive
- [3] Connection for supply voltage, end switch and outputs

Interfaces

Stepper

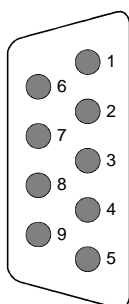

- ① PULSE_P
- ② DIR_P
- ③ reserved
- ④ reserved
- ⑤ Ground
- ⑥ PULSE_N
- ⑦ DIR_N
- ⑧ reserved
- ⑨ reserved

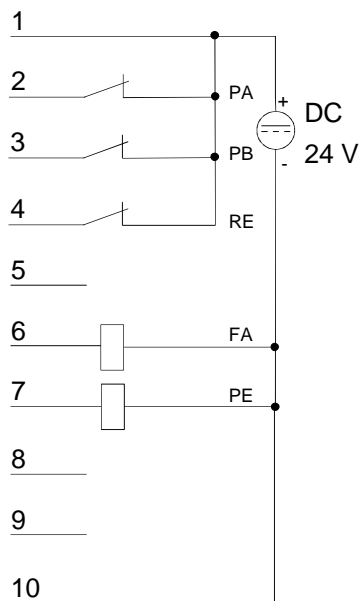

Stepper interface

Via this interface your stepper motor is connected. The interface appears as 9pin D-type-plug and works with RS422 level.

9pin D-type-plug

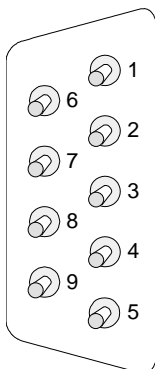

Pin	Assignment
1	PULSE_P: (+) pulse output
2	DIR_P: (+) direction signal
3	reserved
4	reserved
5	GND: ground
6	PULSE_N: (-) pulse output
7	DIR_N: (-) direction signal
8	reserved
9	reserved

Control interface

The control interface provides connection possibilities for end switches and output elements.

The interface has the following pin assignment:



Pin	Assignment
1	Supply voltage DC 24V for outputs
2	Input: end switch PA
3	Input: end switch PB
4	Input: reference switch
5	reserved
6	Output: axis in motion
7	Output: position reached
8	reserved
9	reserved
10	Ground 24V

LEDs

The FM 253 has some LEDs at the front used for status monitoring. The usage and the according colors of these LEDs are shown in the following table:

LED	Color	Description
PW	Green	DC 24V supply voltage is applied
RN	Green	RUN: control active
ER	Red	Internal error
L+	Yellow	DC 24V supply voltage for outputs is applied
PA	Green	Limit value A overrun, input PA is set
PB	Green	Limit value B overrun, input PB is set
RE	Green	Reference point overrun
FA	Green	Drive in run
PE	Green	Drive reached position

Connecting a drive

Connection stepper motor

The connection of a stepper motor is exclusively via the stepper interface.

Connection of supply voltage, end switch and output units

Voltage supply

The module itself is provided via the back plane bus. The deployment of the integrated digital outputs requires an additional voltage supply. The connection of an additional DC 24V supply voltage takes place via the clamps 1 and 10 of the control interface.

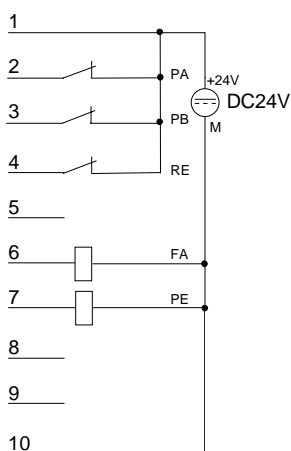

Inputs for end switches

You may connect up to 3 end switches (opener) to the module.

At terminals 2 and 3 (PA and PB) you connect the end switches with which you limit the distance. As soon as one of these switches is operated, the drive is stopped immediately and may only be driven into the other direction.

Terminal 4 is for the connection of the reference switch which is responsible for the tuning with the FM 253 module.

Outputs

The module contains 2 outputs that are only controlled by the module:

- FA - drive in run (clamp 6)
- PE - drive reached position (clamp 7)

The states of the outputs are shown via the according LEDs.

Technical data

MotionControl Stepper FM 253

Order no.	253-1BA00
Type	FM 253
Current consumption/power loss	
Current consumption from backplane bus	500 mA
Power loss	3 W
Status information, alarms, diagnostics	
Status display	yes
Interrupts	no
Process alarm	no
Diagnostic interrupt	no
Diagnostic functions	no
Diagnostics information read-out	none
Supply voltage display	yes
Group error display	red LED
Channel error display	none
Datasizes	
Input bytes	16
Output bytes	16
Parameter bytes	18
Diagnostic bytes	0
Housing	
Material	PPE / PA 6.6
Mounting	Profile rail 35 mm
Mechanical data	
Dimensions (WxHxD)	25.4 x 76 x 78 mm
Weight	70 g
Environmental conditions	
Operating temperature	0 °C to 60 °C
Storage temperature	-25 °C to 70 °C
Certifications	
UL508 certification	yes

**Additional
Technical Data**

Electrical data	253-1BA00
Number of axis	1
Voltage supply	DC 24V (20.4 ... 28.8) via front from ext. power supply
Connectors / Interfaces	
"Drive"-Interface	Output for pulse, direction and release with RS422
Digital inputs	
Number	3
Function	2 end switch, reference switch
Signal voltage "0"	0 ... 5V
Signal voltage "1"	15 ... 28.8V
Digital outputs	
Number	2
Function	"axis in motion", "position reached"
Output current	1A protected against sustained short circuits
Potential separation	yes
Max. Impulse frequency	25 000Hz
Min. Impulse frequency	125Hz
Width of pulse	
125 ... 10 000Hz	>10µs
10 001 ... 25 000Hz	>5µs

Chapter 3 Deployment

Overview This chapter contains information about the data transfer and the operating modes of the MotionControl Stepper module FM 253 for stepper motors.

Contents	Topic	Page
	Chapter 3 Deployment	3-1
	Data transfer CPU >> FM 253	3-2
	Parameterization	3-3
	Operating modes.....	3-5
	Data transfer FM 253 >> CPU	3-10
	Handling blocks.....	3-12

Data transfer CPU >> FM 253

Drive data

The MotionControl Stepper module fetches a data block from the CPU cyclically and analyzes it.

The data block has a length of 16Byte and the following structure:

Byte No.	Content	Length
0-3	Scheduled position	4Byte
4-7	Scheduled frequency	4Byte
8-9	Reserved	
10	Mode	1Byte
11	Index	1Byte
12-15	Variable parameters	4Byte

Via the "Mode" Byte the contents of the data block are specified. The following functions may be initiated via the "Mode" Byte:

Mode (Byte 10)

Mode	Preset in Byte	Response in Byte
00: Idle-Mode - no status change of the drive, serves for parameter changes	-	-
01: Positioning relative - driving the preset number of steps	0-3: rel. set position	-
02: Reference run - calibration of the drive	15: Parameter bits	-
03: Permanent run axis - drive runs with scheduled frequency	4-7: set frequency	-
04: Read inputs - responds with the end switches states	-	15: State
05: Motor parameters - transmits parameters depending on index	11: Index, 12-15: Parameter	-
06: Set position - sets the recent position in the module without moving the drive	0-3: Set position	-
07: Delete error - deletes the error bit activated with 1	14-15: Error bit	-
08: Positioning absolute - drive to scheduled position	0-3: abs. set position	-

Parameter transfer (Mode = 05h)

Via **Index (Byte 11)** you set the parameter which value may be predefined via **Byte 12-15**. The value is transferred to the module by setting the **Mode 05h in Byte 10**.

Parameterization

Overview

The parameter data is transferred to the module together with the drive data in the 16Byte sized data block. For the parameterization you type the parameter to change in the **Index Byte (Byte 11)** via the **Index no..**

The new value is fixed in **Byte 12-15**.

As soon as you set the **Mode Byte (Byte 10)** to **05h**, the parameter is transferred to the module.



Note!

Please regard, that new parameters are only taken over when there has been a mode change before. For this you switch into the IDLE-Mode (MODE-Byte 10 = 00h) after every parameter transfer.

Store parameters in the flash

The parameters that you transfer to the module are stored in the RAM. As long as the module is supplied with voltage, the parameters are preserved. Via the index no. 61h you also have the possibility to store the parameters in the internal flash.

So the parameters are available again after PowerOn.



Note!

With the first start-up you should parameterize the module, due to the system the module has invalid parameters.

Parameterization via FCs

You get FCs from VIPA that should make the deployment of the FM 253 easier. For example you may parameterize your module via the FCs 201 and 202.

The control of the drive functions via FC 200. Via this FC you may access all modes except "Set parameters".

Context of the parameters

The following illustration shows the important contexts of the parameters.

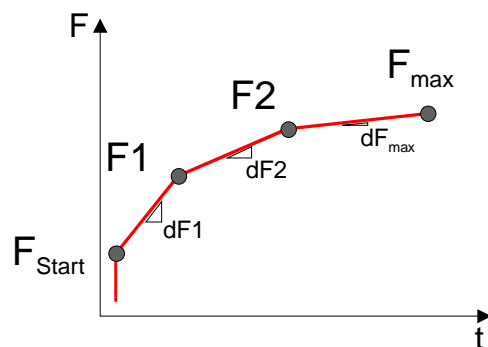

Set index no. at parameter

The assignment of the according index no. is to find in the table below. Via the index no. you fix the parameter in Byte 11, where the value may be preset in Byte 12 ... 15.

Index	Parameter	Unit	Value range	Default	Description
00h	Fstart	Hz	UINT32	200	Start frequency (min. 125Hz)
01h	F1	Hz	UINT32	4000	Limit frequency 1
02h	dF1	Hz	UINT32	100	Acceleration of Fstart ⇒ F1
03h	F2	Hz	UINT32	10000	Limit frequency 2
04h	dF2	Hz	UINT32	60	Acceleration of F1 ⇒ F2
05h	Fmax	Hz	UINT32	15000	Maximum drive frequency (max. 25 000Hz)
06h	dFmax	Hz	UINT32	40	Acceleration of F2 ⇒ Fmax
07h	Fpos	Hz	UINT32	15000	Frequency at positioning
08h	Fref	Hz	UINT32	1000	Frequency for reference run
09h	steps	Hz	UINT32	10	Steps between calculation frequency (min. 10)
0Ah	Fist	Hz	UINT32	-	Recent motor frequency (read only)
0Bh	Fsoll	Hz	UINT32	-	Recent set frequency (read only)
0Dh	FTarget	Hz	UINT32	-	Target frequency (read only)
61h				-	Store parameters in Flash
62h				-	Read parameters from Flash (State like after PowerON)
63h				-	Load default parameters



Note!

When setting parameters for the drive, you should remember the following rules:

- **dF1** should always be **smaller** than **Fstart**
- **dF2** should be the **half** of **dF1**
- **dFmax** should be the **half** of **dF2**

For this the following context appears:

$$4 \cdot dF_{\max} = 2 \cdot dF2 = dF1 < F_{\text{Start}}$$

Wrong inputs are partly corrected by the firmware of the module.

Operating modes

- Overview** By setting according bits in the "MODE"-Byte you may set the following operating modes described below:
- IDLE-Mode
 - Positioning relative / absolute
 - Permanent run
 - Set position
 - Reference run
- IDLE-Mode** Default: Byte 10 = 00h
- In the IDLE-Mode no state change of the drive occurs. For new data is only taken over by the module after an state change, you may initiate a mode change by jumping into the IDLE-Mode and back again.
- Via the IDLE-Mode you may e.g. start a new order, for a mode change is recognized by the jump into the IDLE-Mode.
- The operating mode IDLE should always be called when no action shall be initiated. For initiating an action you normally branch into another mode only for a short time and switch then back to the IDLE-Mode.
- Positioning relative** Default: Byte 10 = 01h, Byte 0-3 = relative set position
- At the relative positioning a predefined number of steps is added to the recent position and then approached.
- In this case you have to predefine the position offset (number of steps) as relative scheduled position in Byte 0-3 and then set the **Mode (Byte10) to 01h**.
- By setting the Byte 10 to 01h the relative positioning starts.
- For acceleration and frequency of the drive, the values set in the parameters are used. If there are no presetting, the default values are used.
- As long as the drive is operating, the output "**Axis in run**" is set. After reaching the position this output is cleared and the output "**Position reached**" is set.
- Positioning absolute** Default: Byte 10 = 08h, Byte 0-3 = absolute set position
- At the absolute positioning an absolute scheduled position is approached.
- In this case you have to predefine the position (number of steps) as absolute scheduled position in Byte 0-3 and then set the **Mode (Byte 10) to 08h**.
- By setting the Byte 10 to 08h the absolute positioning starts.

continued ...

... continue Positioning absolute

For acceleration and frequency of the drive, the values set in the parameters are used. If there are no presetting, the default values are used. As long as the drive is operating, the output "**Axis in run**" is set. After reaching the position this output is cleared and the output "**Position reached**" is set.

Permanent run

Default: Byte 10 = 03h, Byte 4-7 = Scheduled frequency (125 ... 25 000Hz)
If the nominal frequency is less than 125Hz, it will be reset. The frequency Fmax limits the maximum of nominal frequency.

At permanent run the axis rotates with the set frequency until it is changed.

In this case you have to predefine the rotational speed as set frequency in Byte 4-7 and then set **Mode (Byte10) to 03h**.

By setting Byte 10 to 03h the drive starts and rotates with the given frequency until a new frequency value is set.

A new frequency is only taken over at mode change. This is reachable by changing into the IDLE-Mode (Byte 10 = 00h) after the start-up of the drive. Now type the new scheduled frequency and set Byte 10 back to 03h. The drive is set to the new frequency immediately.

For acceleration of the drive, the values set in the parameters are used. If there are no presetting, the default values are used.

As long as the drive is operating, the output "**Axis in run**" is set. By presetting 00h as scheduled frequency (mode change required) the drive stops and the output is set back.

Stop drive by permanent run and set frequency = 00h

By setting a scheduled frequency of 00h in Byte 4-7 and the mode 03h in Byte 10 you may stop the drive at any time.



Note!

Please regard, that a frequency change is only recognized by the module via a mode change. This is also valid for stopping the drive. For a mode change, use the short time jump to the IDLE-Mode.

Set position

Default: Byte 10 = 06h, Byte 0-3: Position value

In the operating mode "Set position" you may assign a new value to the recent actual value.

In this case you predefine the new value in Byte 0-3 and then set the Mode-Byte 10 to 06h.

Reference run

Default: Byte 10 = 02h, Byte 15 = Control bits for reference run

The reference run supports the calibration of your drive system. The reference point should be inside the drive outline.

Before starting a reference run you have to specify the type of the reference run and the direction to run to in Byte 15.

By setting Byte 10 to 02h, the drive starts with its reference run.

As frequency the reference frequency set in the parameters are used. If there are no parameters, the default values are used.

There are 6 different possibilities for the reference drive that are predefined via Byte 15:

- Reference run to reference switch and delete position counter
- Reference run to reference switch and keep position counter
- Reference run to end switch B and delete position counter
- Reference run to end switch B and keep position counter
- Reference run to end switch A and delete position counter
- Reference run to end switch A and keep position counter



Note!

Due to the system a reference run may not be interrupted by a mode change.

Please wait until the reference run is finished.

Control bits for the reference run

The control bits in Byte 15 have the following assignment:

Byte 15	Parameter
Bit 0	1: Direction forward 0: Direction backward
Bit 1	1: delete position after reference run 0: keep position after reference run
Bit 2	Reference run to reference switch
Bit 3	Reference run to end switch B
Bit 4	Reference run to end switch A



Note!

When starting a reference run, please regard, that you always have to set a direction via Bit 0 and that you may set only one bit in the Bits 2 ... 4!

Reference run to reference switch

The reference run starts always with the speed predefined in Fref. The direction has to be preset in the variable parameter (Byte 15, Bit 0). As soon as the ascending edge of the reference switch is recognized, the motor slows down to half speed.

Depending on the reference speed the drive may overrun the reference switch or not during slow down.

The following 4 drives to the reference switch are possible:

1. Motor comes from the left side, slows down inside the reference switch and drives backward with half speed until the descending edge of the reference switch is recognized.
2. Motor comes from the left side, overruns the reference switch during slow down and drives backward with half speed over the ascending edge until the descending edge of the reference switch is recognized.
3. Motor comes from the right side, slows down inside the reference switch and drives with half speed until the descending edge of the reference switch is recognized.
4. Motor comes from the left side, overruns the reference switch during slow down, it changes the rotational direction and drives with half speed until the ascending edge of the reference switch is recognized, switches the direction again and drives on until the descending edge of the reference switch is recognized.

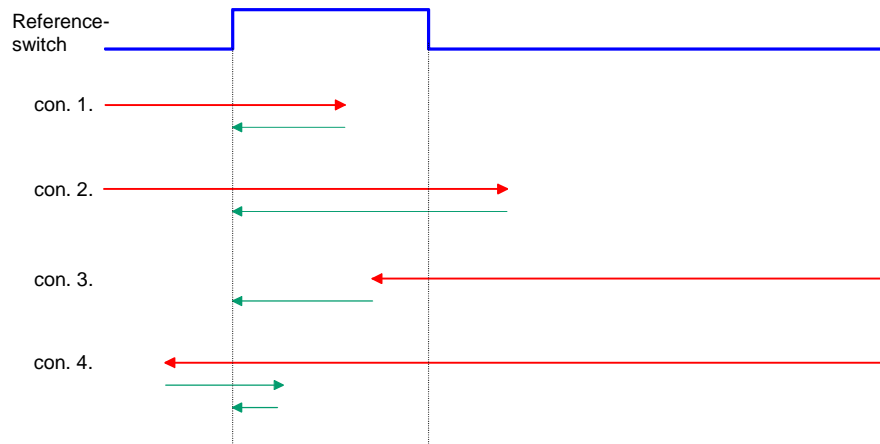

Reference run to end switch

You may limit your distance via the end switches A and B.

There are 2 possibilities to approach the end switch for reference run:

Reference run to end switch A, direction backward

If a falling edge at the end switch B recognized the direction changes again to a rising edge on B end switch is reached.

Reference run to end switch B, direction forward

If a falling edge at the end switch A recognized the direction changes again to a rising edge on A end switch is reached.

Error

At reference run to A respectively B the with operating the end switch the drive is stopped and the module reports an error.

In order to be able to leave the end switch position again, you have to acknowledge the error. This is only possible, when the end switch is not operated respectively bypassed. To bypass you have to connect Pin 2 respectively Pin 3 (PA respectively PB) to DC 24V.

**Note!**

If you use the reference run to end switch, you have to regard, that there is enough space behind the end switch for the motor to slow down!

Data transfer FM 253 >> CPU

Respond message The MotionControl Stepper module sends a data block to the CPU cyclically that contains several information about the recent state of the drive. The data block has a length of 16Byte and the following structure:

Byte no.	Content	Length
0-3	actual position	4 Byte
4-7	actual frequency	4 Byte
8-9	error messages	2 Byte
10	actual mode	1 Byte
11	state	1 Byte
12-15	data of variables	4 Byte

Actual position, actual frequency

Via this two parameters the actual position and frequency of your drive is always shown.

Error messages

The recently recognized errors are monitored via the error bits of Byte 8-9. The errors remain active until the according Bits are set back.

As long as an error is still valid, the according error bit is set again after the reset.

The following error messages are used:

Error byte (Byte 8-9)

Byte 9	Description
Bit 0	Error in the internal state administration
Bit 1	System has been booted (always after PowerON)
Bit 2	Error at proofing Flash parameters, motor parameters not valid
Bit 3	This function is not permitted during motor run
Bit 4	Motor is recently blocked
Bit 5	Error at positioning the motor
Bit 6	End switch is/was active
Bit 7	Frequency has been limited to FMAX
Byte 8	
Bit 0	General error at the motor
Bit 1	Fstart < 125Hz
Bit 2	Fmax > 25 000Hz
Bit 3	Value of steps < 10

Set back error messages

For deleting an active error (Byte 8-9) you have to set the according error bit in the variables parameter (Byte 14-15) to "1".

As soon as you set the **Mode (Byte 10)** to **7**, the according errors in the module are set back. You may also set back several error messages at the same time. FFFFh in Byte 14-15 for example sets back all errors.

Recent mode

Here you always find the mode that your FM 253 has at the moment. The following modes may be shown:

Mode (Byte 10)

Byte	Mode
10	00h: Idle 01h: Positioning relative 02h: Reference run 03h: Permanent run axis 04h: Read inputs 05h: Change motor parameters 06h: Set position 07h: Delete error 08h: Positioning absolute

State

The STATE-Byte shows you the state of the drive. The following state messages may be shown:

State (Byte 11)

Byte 11	State
Bit 0	1: Drive in run 0: Drive in stop
Bit 1	1: Direction forward 0: Direction backward
Bit 2	1: Drive in position 0: Drive not in position

Read inputs

For reading the inputs, the **Mode (Byte 10)** is set to **4** and now the module shows the state of the end switches and the reference switch in the variables data (Byte 15).

Inputs (Byte 15)

Byte 15	Input
Bit 0	State PA end switch (1: operated, 0: not operated)
Bit 1	State PB end switch (1: operated, 0: not operated)
Bit 2	State RE reference switch (1: operated, 0: not operated)

Handling blocks

Overview

There are different handling blocks available with the FM 253 to make the usage of the module more comfortable.

The following handling blocks are available for the FM 253 at this time:

Block	Description
FC 200	Control drive
FC 201	Adjustment of a parameter
FC 202	Adjustment of all drive parameters (Index 0 ... 9)

FC 200 Control drive

This FC serves the control of your drive by transferring the drive data to the module through setting the according mode.

With this FC you may transfer all modes except "Set parameters" and the according parameters to the module.

Data transfer to FM 253 with SET_MODE = 1

- Set the mode.
- Give data to the according parameters.
- Start the transfer by setting SET_MODE to 1. When the mode is started, the module SET_MODE is set back at the next cycle and shows the actual data of the FM 253.

Data transfer to CPU with SET_MODE = 0

At the call of the FC 200 with SET_MODE = 0, the actual data of the FM 253 is shown via the labels ACT_POSITION, ACT_FREQUENCY, ACT_MODE, ERROR, STATE and VAR_DATA.

It is convenient to store the single values in a data block. In the following example we used DB5 for this purpose.

Parameters

Parameter	Declaration	Data Type	Description
ADDRESS	IN	INT	Set basic address
SOLL_POSITION	IN	DINT	Transfer position values
SOLL_FREQUENCY	IN	DINT	Transfer frequency at permanent run
VARIABLES	IN	DWORD	Transfer variables at reference run
MODE	IN	INT	Transfer mode to change
ACT_POSITION	OUT	DINT	Response actual position
ACT_FREQUENCY	OUT	DINT	Response actual frequency
ERROR	OUT	INT	Error word
ACT_MODE	OUT	INT	Response actual mode
STATE	OUT	BYTE	Response status bits
VAR_DATA	OUT	DWORD	Response variables
SET_MODE	IN_OUT	BOOL	Start function

ADDRESS Start address from where on the FM 253 is stored in the CPU.

SET_POSITION In mode 01, 06 and 08 you fix the scheduled position for the drive here.

SET_FREQUENZ In mode 03 you fix the scheduled rotational speed as set frequency.

VARIABLES Fix here the control bits for the reference run (MODE = 02) and for setting the errors back (MODE = 07).

The control bits for the reference run have the following assignment:

Control bits

VARIABLE-Byte	Parameter
Bit 0	1: Direction forward 0: Direction backward
Bit 1	1: after reference run delete position 0: after reference run keep position
Bit 2	Reference run to reference switch
Bit 3	Reference run to end switch B
Bit 4	Reference run to end switch A

An overview over the error bit assignment follows below.

MODE With this parameter you transfer the mode to the FM 253.
The following modes are possible:

Mode

Value	Description	Default in	Response in
00	Idle-Mode - no status change of the drive, serves for parameter changes	-	-
01	Positioning relative - driving the preset number of steps	SET_POSITION	-
02	Reference run - calibration of the drive	VARIABLES	-
03	Permanent run axis - drive runs with scheduled frequency	SET_FREQUENCY	-
04	Read inputs - responds with the end switches states	-	VAR_DATA
06	Set position - sets the recent position in the module without moving the drive	SET_POSITION	-
07	Delete error - deletes the error bit activated with 1	VARIABLES	-
08	Positioning absolute - drive to scheduled position	SET_POSITION	-

ACT_POSITION, ACT_FREQUENCY Via those parameters the recent actual position and actual frequency of your drive is shown.

ERROR Here you may find error messages if occurred. The errors remain active until the error cause is removed and the according bits are set back. The following error messages may occur:

Error messages

ERROR-Byte 1	Description
Bit 0	Error in the internal state administration
Bit 1	System booted (always after PowerON)
Bit 2	Error at validating the Flash parameters, motor parameters not valid
Bit 3	Function is not available during motor run
Bit 4	Motor is blocked
Bit 5	Error at positioning the motor
Bit 6	End switch is/was active
Bit 7	Frequency has been limited to FMAX
ERROR-Byte 0	
Bit 0	General error at the motor
Bit 1	Fstart < 125Hz
Bit 2	Fmax > 25 000Hz
Bit 3	Value of steps < 10

The clearing of the error messages takes place via MODE = 07 and VARIABLE = Error bytes.

ACT_MODE Responds the mode in which the module is at this moment.

STATE The STATE-Byte shows you information about the state of the drive. The following state messages may occur:

State

STATE-Byte	State
Bit 0	1: Drive in run 0: Drive in stop
Bit 1	1: Direction forward 0: Direction backward
Bit 2	1: Drive in position 0: Drive not in position

VAR_DATA

In VAR_DATA the state of the inputs is returned after you requested this by MODE = 04. For reading the inputs the **Mode 4** is set and now the module shows the state of the end switches and the reference switch in the variables data (Byte 15).

Inputs

VAR_DATA-Byte	Input
Bit 0	State PA end switch (1: operated, 0: not operated)
Bit 1	State PB end switch (1: operated, 0: not operated)
Bit 2	State RE reference switch (1: operated, 0: not operated)

SET_MODE

After you defined the according parameters the data is transferred to your module via SET_MODE = 1.

When the mode has been started, the module sets back again the SET_MODE in the next cycle and returns the "actual" data of the FM 253.

Example

```

DB 5
DBD 0 Position          DINT   L#0    Position value
DBD 4 Frequency        DINT   L#0    Frequency for permanent run
DBW 8 reserve          WORD   W#16#0
DBW 10 MODE            INT    0      Mode
DBW 12 Index          INT    0      Index default
DBD 14 Variable_PARAM DWORD  DW#16#0 Var. for Ref.run/Param...
DBW 18 Reserve1       WORD   W#16#0
DBD 20 Act_Position   DINT   L#0    actual position
DBD 24 Act_Frequency  DINT   L#0    actual frequency
DBW 28 Error          INT    0      error monitor
DBW 30 ACT_Mode       INT    0      actual mode
DBW 32 State          BYTE   B#16#0 State response
DBD 34 VAR_DATA       DWORD  DW#16#0 Return parameter/data

CALL FC 200           //FC for Stepper module
ADDRESS              :=128      //Module address
SET_POSITION         :=DB5.DBD 0 //DBD with position for abs/rel
SET_FREQUENCY        :=DB5.DBD 4 //DBD with frequency for permanent run
VARIABLES            :=DB5.DBD14 //Delete data for Ref_Run/Del error
MODE                 :=DB5.DBW10 //Mode default for new order
SET_MODE             :=M1.0     //Start order
ACT_POSITION         :=DB5.DBD20 //actual position
ACT_FREQUENCY        :=DB5.DBD24 //actual frequency
ERROR                :=DB5.DBW28 //Monitor error
ACT_MODE             :=DB5.DBW30 //actual mode
STATE                :=DB5.DBW32 //State bits from module
VAR_DATA             :=DB5.DBD34 //Return of values
                        e.g. read inputs

```

FC 201 - set a parameter With the FC 201 it is possible to set a parameter at the FM 253.

Parameter

Parameter	Declaration	Data Type	Description
ADDRESS	IN	INT	Fixed basic address
INDEX	IN	INT	Transfer INDEX for parameters
PARAMETER	IN	DWORD	Transfer parameter value
	OUT		
SET_PARA	IN_OUT	BOOL	Start parameter transfer

ADDRESS Start address from where on the FM 253 is stored in the CPU.

INDEX Via INDEX you fix the parameter where the value is set in PARAMETER.

Index	Parameter	Unit	Value range	Default	Description
00h	Fstart	Hz	UINT32	200	Start frequency
01h	F1	Hz	UINT32	4000	Limit frequency 1
02h	dF1	Hz	UINT32	100	Acceleration from Fstart ⇒ F1
03h	F2	Hz	UINT32	10000	Limit frequency 2
04h	dF2	Hz	UINT32	60	Acceleration from F1 ⇒ F2
05h	Fmax	Hz	UINT32	15000	Maximum drive frequency (max. 25 000Hz))
06h	dFmax	Hz	UINT32	40	Acceleration from F2 ⇒ Fmax
07h	Fpos	Hz	UINT32	15000	Frequency at positioning
08h	Fref	Hz	UINT32	1000	Frequency for reference run
09h	steps		UINT32	10	Steps between calculation frequency (min. 10)
0Ah	Fist	Hz	UINT32	-	Recent motor frequency (read only)
0Bh	Fsoll	Hz	UINT32	-	Recent set frequency (read only)
0Dh	FTarget	Hz	UINT32	-	Target frequency (read only)
61h				-	Store parameter in Flash
62h				-	Read parameter from Flash (state like after PowerON)
63h				-	Load default parameters

PARAMETER Here you type the value of the parameter specified via INDEX.

SET_PARA After you filled the according parameters, the parameter is transferred to your module via SET_PARA = 1. After the transfer SET_PARA is set back automatically.

Parameterize FC 202 - FM 253 Via the FC 202 you may adjust all relevant parameters of the FM 253.

Parameter

Parameter	Declaration	Data Type	Description
DATA_DB	IN	BLOCK_DB	Data block with parameters
ADDRESS	IN	INT	Module address
	OUT		
START	IN_OUT	BOOL	Start parameter transfer
RUN	IN_OUT	BOOL	Transfer single runs

DATA_DB Please fix here the data block where your parameters are stored. The DB has the following structure:

```

DB 5
DBD 46 Fstart      DINT  L#0  Start frequency
DBD 50 F1          DINT  L#0  Limit frequency 1
DBD 54 F2          DINT  L#0  Limit frequency 2
DBD 58 Fmax        DINT  L#0  Maximum drive frequency
DBD 62 dF1         DINT  L#0  Acceleration Fstart --> F1
DBD 66 dF2         DINT  L#0  Acceleration F1 --> F2
DBD 70 dFmax       DINT  L#0  Acceleration F2 --> Fmax
DBD 74 Fpos        DINT  L#0  Frequency at positioning
DBD 78 Fref        DINT  L#0  Frequency at reference run
DBD 82 StepRepeat  DINT  L#0  Step between frequency calculation
    
```

ADDRESS Start address, the data of the set-off from FM 253 in the CPU.

START After you created the DB you may transfer your parameters to your module via START = 1. As soon as all parameters are transferred, START is set back again.

RUN This variable stores one cycle spreading state and it is responsible for the single parameter transfer.

