

# System SLIO

## SM-AIO | | Manual

HB300 | SM-AIO | | en | 24-24

Analog signal modules - SM 03x



YASKAWA Europe GmbH  
Philipp-Reis-Str. 6  
65795 Hattersheim  
Germany  
Tel.: +49 6196 569-300  
Fax: +49 6196 569-398  
Email: [info@yaskawa.eu](mailto:info@yaskawa.eu)  
Internet: [www.yaskawa.eu.com](http://www.yaskawa.eu.com)

## Table of contents

<b>1</b>	<b>General</b>	<b>8</b>
1.1	Copyright © YASKAWA Europe GmbH	8
1.2	About this manual	9
1.3	Safety instructions	10
<b>2</b>	<b>Basics and mounting</b>	<b>12</b>
2.1	Safety notes for the user	12
2.2	System conception	13
2.2.1	Overview	13
2.2.2	Components	14
2.2.3	Accessories	17
2.2.4	Hardware revision	19
2.3	Dimensions	19
2.4	Mounting 8x periphery modules	22
2.5	Mounting 16x periphery modules	25
2.6	Wiring 8x periphery modules	28
2.7	Wiring 16x periphery modules	29
2.8	Wiring power modules	30
2.9	Shielding	34
2.10	Demounting 8x periphery modules	35
2.11	Demounting 16x periphery modules	37
2.12	Easy Maintenance	40
2.13	Trouble shooting - LEDs	41
2.14	Industrial security and installation guidelines	42
2.14.1	Industrial security in information technology	42
2.14.2	Installation guidelines	44
2.15	General data for the System SLIO	47
2.15.1	Use in difficult operating conditions	48
2.16	System SLIO product variants for extended application range	49
<b>3</b>	<b>Analog input</b>	<b>50</b>
3.1	General	50
3.2	Analog value	51
3.3	Measuring ranges and function numbers	52
3.3.1	Voltage	52
3.3.2	Current	54
3.3.3	Resistance	55
3.3.4	Temperature	59
3.4	031-1BB10 - AI 2x12Bit 0(4)...20mA - ISO	61
3.4.1	Technical data	63
3.4.2	Parameter data	66
3.4.3	Diagnostics and interrupt	68

3.5	031-1BB30 - AI 2x12Bit 0...10V	73
3.5.1	Technical data	75
3.5.2	Parameter data	78
3.5.3	Diagnostic data	78
3.6	031-1BB40 - AI 2x12Bit 0(4)...20mA	82
3.6.1	Technical data	84
3.6.2	Parameter data	87
3.6.3	Diagnostic data	88
3.7	031-1BB60 - AI 2x12Bit 0(4)...20mA - Sensor	91
3.7.1	Technical data	93
3.7.2	Parameter data	96
3.7.3	Diagnostic data	97
3.8	031-1BB70 - AI 2x12Bit $\pm$ 10V	100
3.8.1	Technical data	102
3.8.2	Parameter data	105
3.8.3	Diagnostic data	106
3.9	031-1BB90 - AI 2x16Bit TC	109
3.9.1	Technical data	111
3.9.2	Parameter data	115
3.9.3	Diagnostics and interrupt	120
3.10	031-1BD30 - AI 4x12Bit 0...10V	124
3.10.1	Technical data	126
3.10.2	Parameter data	129
3.10.3	Diagnostic data	129
3.11	031-1BD40 - AI 4x12Bit 0(4)...20mA	133
3.11.1	Technical data	135
3.11.2	Parameter data	138
3.11.3	Diagnostic data	139
3.12	031-1BD70 - AI 4x12Bit $\pm$ 10V	142
3.12.1	Technical data	144
3.12.2	Parameter data	147
3.12.3	Diagnostic data	148
3.13	031-1BD80 - AI 4x16Bit R/RTD	151
3.13.1	Technical data	153
3.13.2	Parameter data	157
3.13.3	Diagnostics and interrupt	163
3.14	031-1BF60 - AI 8x12Bit 0(4)...20mA	167
3.14.1	Technical data	169
3.14.2	Parameter data	172
3.14.3	Diagnostic data	173



3.15	031-1BF74 - AI 8x12Bit $\pm 10V$ .....	176
3.15.1	Technical data.....	178
3.15.2	Parameter data.....	181
3.15.3	Diagnostic data.....	183
3.16	031-1CA20 - AI 1x16(24)Bit Strain gauge (DMS).....	186
3.16.1	Connection variants.....	188
3.16.2	In-/Output area.....	190
3.16.3	Technical data.....	192
3.16.4	Functionality.....	194
3.16.5	Parameter data.....	196
3.16.6	Deployment of the filter functions.....	199
3.16.7	Calibration.....	200
3.16.8	Steady state detection.....	201
3.16.9	Diagnostics.....	201
3.17	031-1CB30 - AI 2x16Bit 0...10V.....	205
3.17.1	Technical data.....	207
3.17.2	Parameter data.....	210
3.17.3	Diagnostics and interrupt.....	212
3.18	031-1CB40 - AI 2x16Bit 0(4)...20mA.....	216
3.18.1	Technical data.....	218
3.18.2	Parameter data.....	221
3.18.3	Diagnostics and interrupt.....	223
3.19	031-1CB70 - AI 2x16Bit $\pm 10V$ .....	227
3.19.1	Technical data.....	229
3.19.2	Parameter data.....	232
3.19.3	Diagnostics and interrupt.....	234
3.20	031-1CD30 - AI 4x16Bit 0...10V.....	238
3.20.1	Technical data.....	240
3.20.2	Parameter data.....	243
3.20.3	Diagnostics and interrupt.....	245
3.21	031-1CD35 - AI 4x16Bit 0...10V.....	249
3.21.1	Technical data.....	251
3.21.2	Parameter data.....	254
3.21.3	Diagnostic data.....	255
3.22	031-1CD40 - AI 4x16Bit 0(4)...20mA.....	258
3.22.1	Technical data.....	260
3.22.2	Parameter data.....	263
3.22.3	Diagnostics and interrupt.....	266
3.23	031-1CD45 - AI 4x16Bit 0(4)...20mA.....	270
3.23.1	Technical data.....	272
3.23.2	Parameter data.....	275
3.23.3	Diagnostic data.....	276

3.24	031-1CD70 - AI 4x16Bit $\pm 10V$ . . . . .	279
3.24.1	Technical data. . . . .	281
3.24.2	Parameter data. . . . .	284
3.24.3	Diagnostics and interrupt. . . . .	287
3.25	031-1CF90 - AI 8x16Bit TC. . . . .	291
3.25.1	Technical data. . . . .	294
3.25.2	Parameter data. . . . .	297
3.25.3	Diagnostics and interrupt. . . . .	303
3.26	031-1LB90 - AI 2x16Bit TC. . . . .	308
3.26.1	Technical data. . . . .	310
3.26.2	Parameter data. . . . .	314
3.26.3	Diagnostic data. . . . .	317
3.27	031-1LD80 - AI 4x16Bit R/RTD. . . . .	320
3.27.1	Technical data. . . . .	322
3.27.2	Parameter data. . . . .	325
3.27.3	Diagnostic data. . . . .	330
3.28	031-1PAxx - AI1x 3Ph 230/400V. . . . .	333
3.28.1	Technical data. . . . .	336
3.28.2	Safety precautions. . . . .	340
3.28.3	Basics. . . . .	343
3.28.4	Connection. . . . .	346
3.28.5	Parameter data. . . . .	347
3.28.6	Measurands. . . . .	353
3.28.7	Process data communication. . . . .	361
3.28.8	Error messages and diagnostics. . . . .	374
3.28.9	Product specific handling blocks. . . . .	377
<b>4</b>	<b>Analog output. . . . .</b>	<b>378</b>
4.1	General. . . . .	378
4.2	Analog value. . . . .	378
4.3	Output ranges and function numbers. . . . .	379
4.3.1	Voltage. . . . .	379
4.3.2	Current. . . . .	380
4.4	032-1BB30 - AO 2x12Bit 0...10V. . . . .	382
4.4.1	Technical data. . . . .	384
4.4.2	Parameter data. . . . .	386
4.4.3	Diagnostic data. . . . .	387
4.5	032-1BB40 - AO 2x12Bit 0(4)...20mA. . . . .	390
4.5.1	Technical data. . . . .	392
4.5.2	Parameter data. . . . .	394
4.5.3	Diagnostic data. . . . .	395

4.6	032-1BB70 - AO 2x12Bit $\pm 10V$ .....	399
4.6.1	Technical data.....	401
4.6.2	Parameter data.....	403
4.6.3	Diagnostic data.....	404
4.7	032-1BD30 - AO 4x12Bit 0...10V.....	408
4.7.1	Technical data.....	410
4.7.2	Parameter data.....	412
4.7.3	Diagnostic data.....	413
4.8	032-1BD40 - AO 4x12Bit 0(4)...20mA.....	416
4.8.1	Technical data.....	418
4.8.2	Parameter data.....	420
4.8.3	Diagnostic data.....	421
4.9	032-1BD70 - AO 4x12Bit $\pm 10V$ .....	425
4.9.1	Technical data.....	427
4.9.2	Parameter data.....	429
4.9.3	Diagnostic data.....	430
4.10	032-1CB30 - AO 2x16Bit 0...10V.....	434
4.10.1	Technical data.....	436
4.10.2	Parameter data.....	438
4.10.3	Diagnostic data.....	439
4.11	032-1CB40 - AO 2x16Bit 0(4)...20mA.....	442
4.11.1	Technical data.....	444
4.11.2	Parameter data.....	446
4.11.3	Diagnostic data.....	447
4.12	032-1CB70 - AO 2x16Bit $\pm 10V$ .....	451
4.12.1	Technical data.....	453
4.12.2	Parameter data.....	455
4.12.3	Diagnostic data.....	456
4.13	032-1CD30 - AO 4x16Bit 0...10V.....	460
4.13.1	Technical data.....	462
4.13.2	Parameter data.....	464
4.13.3	Diagnostic data.....	465
4.14	032-1CD40 - AO 4x16Bit 0(4)...20mA.....	468
4.14.1	Technical data.....	470
4.14.2	Parameter data.....	472
4.14.3	Diagnostic data.....	473
4.15	032-1CD70 - AO 4x16Bit $\pm 10V$ .....	477
4.15.1	Technical data.....	479
4.15.2	Parameter data.....	481
4.15.3	Diagnostic data.....	482

# 1 General

## 1.1 Copyright © YASKAWA Europe GmbH

<b>All Rights Reserved</b>	<p>This document contains proprietary information of Yaskawa and is not to be disclosed or used except in accordance with applicable agreements.</p> <p>This material is protected by copyright laws. It may not be reproduced, distributed, or altered in any fashion by any entity (either internal or external to Yaskawa) except in accordance with applicable agreements, contracts or licensing, without the express written consent of Yaskawa and the business management owner of the material.</p> <p>For permission to reproduce or distribute, please contact: YASKAWA Europe GmbH, European Headquarters, Philipp-Reis-Str. 6, 65795 Hattersheim, Germany</p> <p>Tel.: +49 6196 569 300 Fax.: +49 6196 569 398 Email: <a href="mailto:info@yaskawa.eu">info@yaskawa.eu</a> Internet: <a href="http://www.yaskawa.eu.com">www.yaskawa.eu.com</a></p>
<b>EC conformity declaration</b>	<p>Hereby, YASKAWA Europe GmbH declares that the products and systems are in compliance with the essential requirements and other relevant provisions. Conformity is indicated by the CE marking affixed to the product.</p>
<b>Conformity Information</b>	<p>For more information regarding CE marking and Declaration of Conformity (DoC), please contact your local representative of YASKAWA Europe GmbH.</p>
<b>Trademarks</b>	<p>SLIO is a registered trademark of YASKAWA Europe GmbH.</p> <p>CAN is a registered trademark of CAN in Automation e. V. (CiA).</p> <p>EtherCAT is a registered trademark of Beckhoff Automation GmbH.</p> <p>PROFINET and PROFIBUS are registered trademarks of PROFIBUS and PROFINET International (PI).</p> <p>S5 and S7 are registered trademarks of Siemens AG.</p> <p>All other trademarks, logos and service or product marks specified herein are owned by their respective companies.</p>
<b>General terms of use</b>	<p>Every effort has been made to ensure that the information contained in this document was complete and accurate at the time of publishing. We cannot guarantee that the information is free of errors, and we reserve the right to change the information at any time. There is no obligation to inform the customer about any changes. The customer is requested to actively keep his documents up to date. The customer is always responsible for the deployment of the products with the associated documentation, taking into account the applicable directives and standards.</p> <p>This documentation describes all hardware and software units and functions known today. It is possible that units are described that do not exist at the customer. The exact scope of delivery is described in the respective purchase contract.</p>
<b>Document support</b>	<p>Contact your local representative of YASKAWA Europe GmbH if you have errors or questions regarding the content of this document. You can reach YASKAWA Europe GmbH via the following contact:</p> <p>Email: <a href="mailto:Documentation.HER@yaskawa.eu">Documentation.HER@yaskawa.eu</a></p>

**Technical support**

Contact your local representative of YASKAWA Europe GmbH if you encounter problems or have questions regarding the product. If such a location is not available, you can reach the Yaskawa customer service via the following contact:

YASKAWA Europe GmbH,  
European Headquarters, Philipp-Reis-Str. 6, 65795 Hattersheim, Germany  
Tel.: +49 6196 569 500 (hotline)  
Email: support@yaskawa.eu

## 1.2 About this manual

**Objective and contents**

This manual describes the Analog signal modules of the System SLIO.

- It describes the structure, configuration and application.
- The manual is written for users with basic knowledge of automation technology.
- The manual consists of chapters. Each chapter describes a completed topic.
- The following guides are available in the manual:
  - An overall table of contents at the beginning of the manual.
  - References with page numbers.

**Icons and headings**

Important passages in the text are highlighted by following icons and headings:

**DANGER**

Immediate or likely danger. Personal injury is possible.

**CAUTION**

Damages to property is likely if these warnings are not heeded.



*Supplementary information and useful tips.*

## 1.3 Safety instructions

### Suitability for use

- It is the customer's responsibility to confirm conformity with any standards, codes, or regulations that apply if the Yaskawa product is used in combination with any other products.
- The customer must confirm that the Yaskawa product is suitable for the systems, machines, and equipment used by the customer.
- If the Yaskawa product is used in a manner not specified in the manual, the protection provided by the Yaskawa product may be impaired.
- Consult with Yaskawa to determine whether use in the following applications is acceptable. If use in the application is acceptable, use the Yaskawa product with extra allowance in ratings and specifications, and provide safety measures to minimize hazards in the event of failure.
  - Outdoor use, use involving potential chemical contamination or electrical interference, or use in conditions or environments not described in product catalogs or manuals
  - Nuclear energy control systems, combustion systems, railroad systems, aviation systems, vehicle systems, medical equipment, amusement machines, and installations subject to separate industry or government regulations
  - Systems, machines, and equipment that may present a risk to life or property
  - Systems that require a high degree of reliability, such as systems that supply gas, water, or electricity, or systems that operate continuously 24 hours a day
  - Other systems that require a similar high degree of safety
- Never use the Yaskawa product for an application involving serious risk to life or property without first ensuring that the system is designed to secure the required level of safety with risk warnings and redundancy, and that the Yaskawa product is properly rated and installed.
- The circuit examples and other application examples described in product catalogs and manuals are for reference. Check the functionality and safety of the actual devices and equipment to be used before using the Yaskawa product.
- Read and understand all use prohibitions and precautions, and operate the Yaskawa product correctly to prevent accidental harm to third parties.

### Field of application

The system is constructed and produced for:

- communication and process control
- general control and automation tasks
- industrial applications
- operation within the environmental conditions specified in the technical data
- installation into a cubicle



#### **DANGER**

This device is not certified for applications in

- in explosive environments (EX-zone)

**Exclusion of Liability**

- The Yaskawa product is not suited for use in life-support machines or systems.
- Contact a Yaskawa representative or your Yaskawa sales representative if you are considering the application of this Yaskawa product for special purposes, such as machines or systems used for passenger cars, medicine, airplanes and aerospace, nuclear power, electric power or undersea relaying.

**DANGER**

When you use this Yaskawa product in applications where its failure could cause the loss of human life, a serious accident, or physical injury, you must install applicable safety devices.

- If you do not correctly install safety devices, it can cause serious injury or death.

**Disposal**

National rules and regulations apply to the disposal of the unit!

**Documentation**

The manual must be available to all personnel in the:

- project design department
- installation department
- commissioning
- operation

**CAUTION**

The following conditions must be met before using or commissioning the components described in this manual:

- Hardware modifications to the process control system should only be carried out when the system has been disconnected from power!
- Installation and hardware modifications only by properly trained personnel.
- The national rules and regulations of the respective country must be satisfied (installation, safety, EMC ...)

## 2 Basics and mounting

### 2.1 Safety notes for the user



#### DANGER

##### Protection against dangerous voltages

- When using System SLIO modules, the user must be protected from touching hazardous voltage.
- You must therefore create an insulation concept for your system that includes safe separation of the potential areas of ELV and hazardous voltage.
- Here, observe the insulation voltages between the potential areas specified for the System SLIO modules and take suitable measures, such as using PELV/SELV power supplies for System SLIO modules.

#### Handling of electrostatic sensitive modules

The modules are equipped with highly integrated components in MOS technology. These components are highly sensitive to over-voltages that occur, e.g. with electrostatic discharge. The following symbol is used to identify these hazardous modules:



The symbol is located on modules, module racks or on packaging and thus indicates electrostatic sensitive modules. Electrostatic sensitive modules can be destroyed by energies and voltages that are far below the limits of human perception. If a person who is not electrically discharged handles electrostatic sensitive modules, voltages can occur and damage components and thus impair the functionality of the modules or render the modules unusable. Modules damaged in this way are in most cases not immediately recognized as faulty. The error can only appear after a long period of operation. Components damaged by static discharge can show temporary faults when exposed to temperature changes, vibrations or load changes. Only the consistent use of protective devices and responsible observance of the handling rules can effectively prevent malfunctions and failures on electrostatic sensitive modules.

#### Shipping of modules

Please always use the original packaging for shipping.

#### Measurement and modification of electrostatic sensitive modules

For measurements on electrostatic sensitive modules the following must be observed:

- Floating measuring instruments must be discharged before use.
- Measuring instruments used must be grounded.

When modifying electrostatic sensitive modules, ensure that a grounded soldering iron is used.



#### CAUTION

When working with and on electrostatic sensitive modules, make sure that personnel and equipment are adequately grounded.



## 2.2 System conception

### 2.2.1 Overview

The System SLIO is a modular automation system for assembly on a 35mm mounting rail. By means of the periphery modules with 2, 4, 8 and 16 channels this system may properly be adapted matching to your automation tasks. The wiring complexity is low, because the supply of the DC 24V power section supply is integrated to the backplane bus and defective modules may be replaced with standing wiring. By deployment of the power modules in contrasting colors within the system, further isolated areas may be defined for the DC 24V power section supply, respectively the electronic power supply may be extended with 2A.

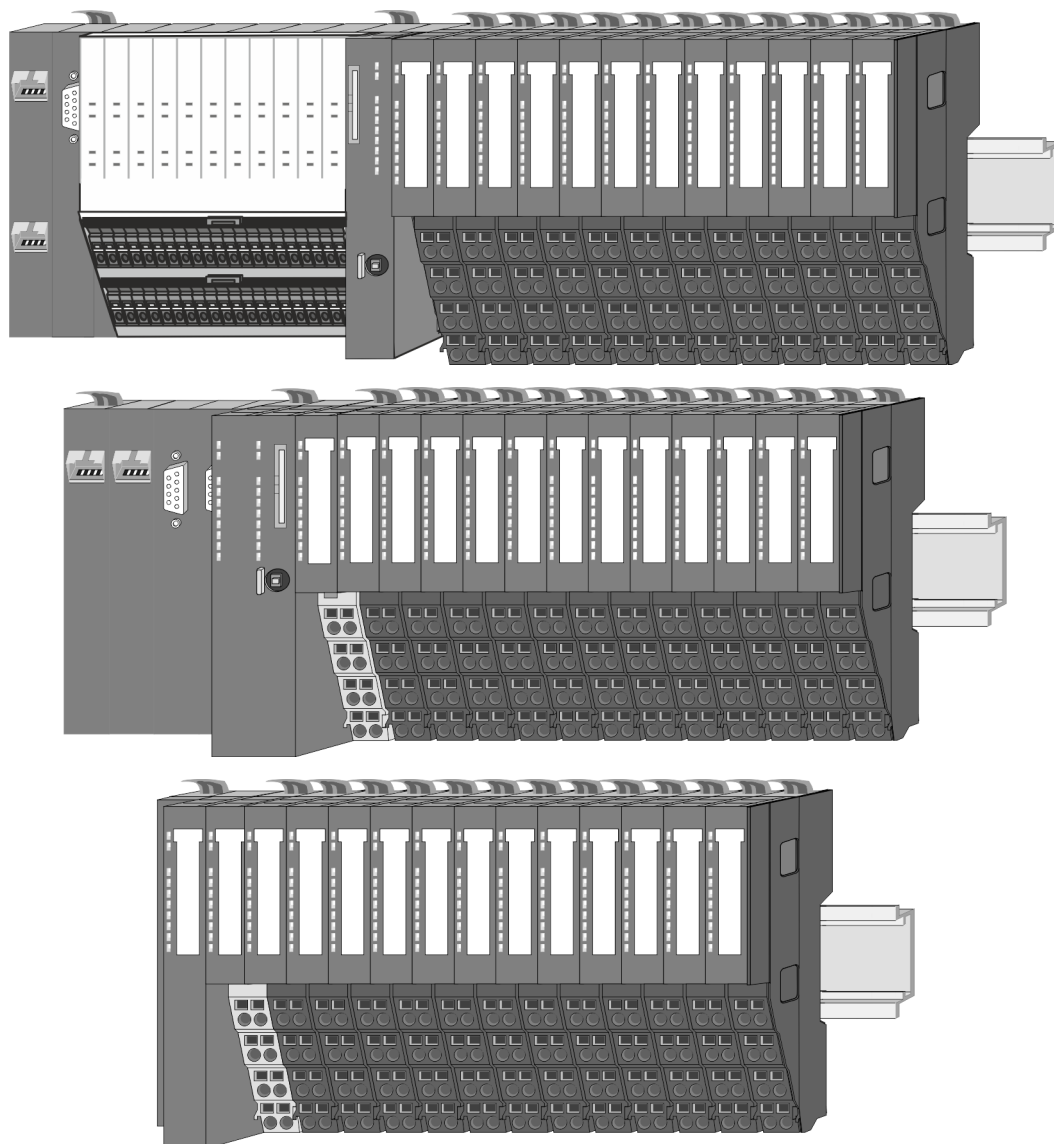

## 2.2.2 Components

- CPU (head module)
- Bus coupler (head module)
- Line extension
- 8x periphery modules
- 16x periphery modules
- Power modules
- Accessories



**CAUTION**

Only Yaskawa modules may be combined. A mixed operation with third-party modules is not allowed!

### CPU 01xC

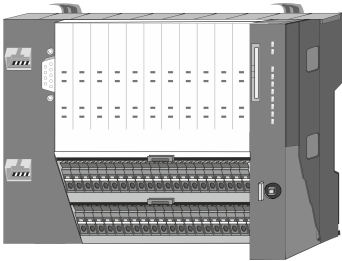

With the CPU 01xC electronic, input/output components and power supply are integrated to one casing. In addition, up to 64 periphery modules of the System SLIO can be connected to the backplane bus. As head module via the integrated power module for power supply CPU electronic and the I/O components are supplied as well as the electronic of the periphery modules, which are connected via backplane bus. To connect the power supply of the I/O components and for DC 24V power section supply of via backplane bus connected periphery modules, the CPU has removable connectors. By installing of up to 64 periphery modules at the backplane bus, these are electrically connected, this means these are assigned to the backplane bus, the electronic modules are power supplied and each periphery module is connected to the DC 24V power section supply.

### CPU 01x

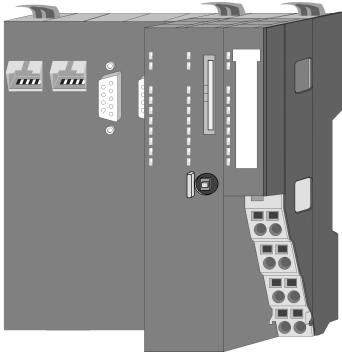

With this CPU 01x, CPU electronic and power supply are integrated to one casing. As head module, via the integrated power module for power supply, CPU electronic and the electronic of the connected periphery modules are supplied. The DC 24V power section supply for the linked periphery modules is established via a further connection of the power module. By installing of up to 64 periphery modules at the backplane bus, these are electrically connected, this means these are assigned to the backplane bus, the electronic modules are power supplied and each periphery module is connected to the DC 24V power section supply.



**CAUTION**

CPU part and power module may not be separated!  
Here you may only exchange the electronic module!

### Bus coupler

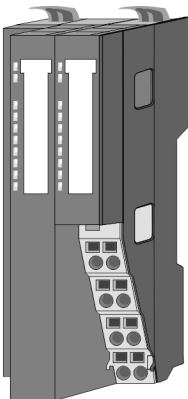

With a bus coupler bus interface and power module is integrated to one casing. With the bus interface you get access to a subordinated bus system. As head module, via the integrated power module for power supply, bus interface and the electronic of the connected periphery modules are supplied. The DC 24V power section supply for the linked periphery modules is established via a further connection of the power module. By installing of up to 64 periphery modules at the bus coupler, these are electrically connected, this means these are assigned to the backplane bus, the electronic modules are power supplied and each periphery module is connected to the DC 24V power section supply.



**CAUTION**

Bus interface and power module may not be separated!  
Here you may only exchange the electronic module!

**Line extension**

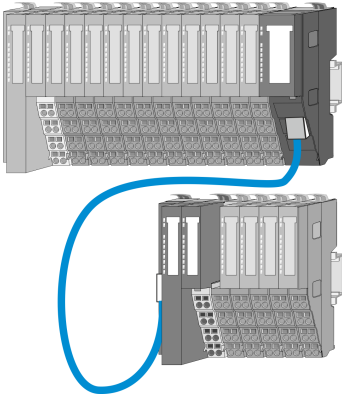

In the System SLIO there is the possibility to place up to 64 modules in on line. By means of the line extension you can divide this line into several lines. Here you have to place a line extension master at each end of a line and the subsequent line has to start with a line extension slave. Master and slave are to be connected via a special connecting cable. In this way, you can divide a line on up to 5 lines. Depending on the line extension, the max. number of pluggable modules at the System SLIO bus is decreased accordingly. To use the line extension no special configuration is required.



*Please note that some modules do not support line extensions due to the system. For more information, please refer to the compatibility list. This can be found in the 'Download Center' of [www.yaskawa.eu.com](http://www.yaskawa.eu.com) under 'System SLIO Compatibility list'.*

**Periphery modules**

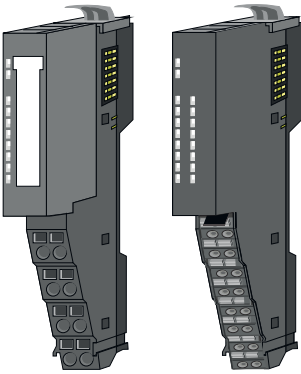

The periphery modules are available in the following 2 versions, whereby of each the electronic part can be replaced with standing wiring:

- 8x periphery module for a maximum of 8 channels.
- 16x periphery module for a maximum of 16 channels.

**8x periphery modules**

Each 8x periphery module consists of a *terminal* and an *electronic module*.

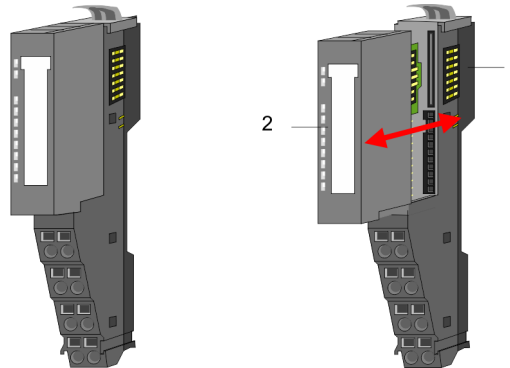

- 1 Terminal module
- 2 Electronic module

**Terminal module**

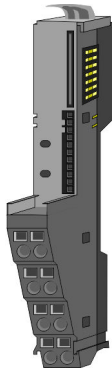

The *terminal module* serves to carry the electronic module, contains the backplane bus with power supply for the electronic, the DC 24V power section supply and the staircase-shaped terminal for wiring. Additionally the terminal module has a locking system for fixing at a mounting rail. By means of this locking system your system may be assembled outside of your switchgear cabinet to be later mounted there as whole system.

**Electronic module**

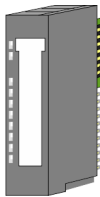

The functionality of a periphery module is defined by the *electronic module*, which is mounted to the terminal module by a sliding mechanism. With an error the defective electronic module may be exchanged for a functional module with standing installation. At the front side there are LEDs for status indication. For simple wiring each module shows corresponding connection information at the front and at the side.

**16x periphery modules**

Each 16x periphery module consists of an *electronic unit* and a *terminal block*.

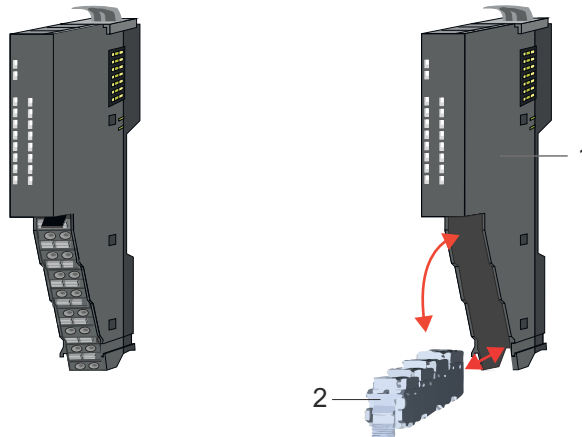

- 1 Electronic unit
- 2 Terminal block

**Electronic unit**

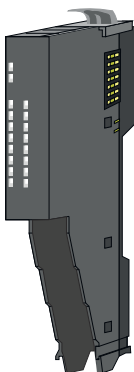

With the 16x periphery module the terminal block is connected to the *electronic unit* via a secure flap mechanism. In the case of an error you can exchange the defective electronic unit for a functional unit with standing wiring. At the front side there are LEDs for status indication. For easy wiring each electronic unit shows corresponding connection information at the side. The electronic unit provides the slot for the terminal block for the wiring and contains the backplane bus with power supply for the electronic and the connection to the DC 24V power section supply. Additionally the electronic unit has a locking system for fixing it at a mounting rail. By means of this locking system your system may be assembled outside of your switchgear cabinet to be later mounted there as whole system.

**Terminal block**



The *terminal block* provides the electrical interface for the signalling and supplies lines of the module. When mounting the terminal block, it is attached to the bottom of the electronic unit and turned towards the electronic unit until it clicks into place. With the wiring a "push-in" spring-clip technique is used. This allows a quick and easy connection of your signal and supply lines. The clamping off takes place by means of a screwdriver.

**Power module**

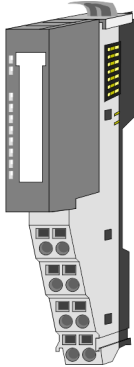

In the System SLIO the power supply is established by power modules. These are either integrated to the head module or may be installed between the periphery modules. Depending on the power module isolated areas of the DC 24V power section supply may be defined respectively the electronic power supply may be extended with 2A. For better recognition the colour of the power modules are contrasting to the periphery modules.

2.2.3 Accessories

**Shield bus carrier**



*Please note that a shield bus carrier cannot be mounted on a 16x periphery module!*



The shield bus carrier (order no.: 000-0AB00) serves to carry the shield bus (10mm x 3mm) to connect cable shields. Shield bus carriers, shield bus and shield fixings are not in the scope of delivery. They are only available as accessories. The shield bus carrier is mounted underneath the terminal of the terminal module. With a flat mounting rail for adaptation to a flat mounting rail you may remove the spacer of the shield bus carrier.

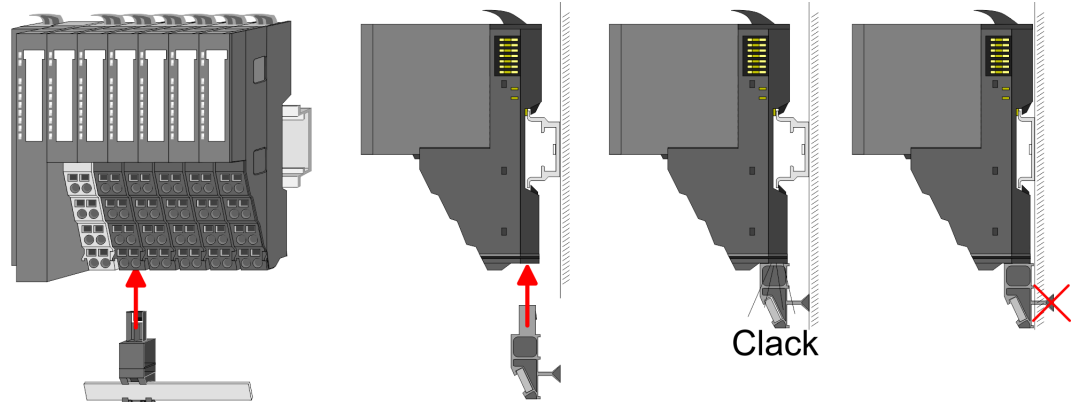

**Bus cover**

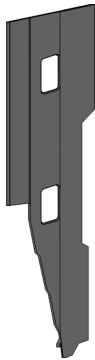

With each head module, to protect the backplane bus connectors, there is a mounted bus cover in the scope of delivery. You have to remove the bus cover of the head module before mounting a System SLIO module. For the protection of the backplane bus connector you always have to mount the bus cover at the last module of your system again. The bus cover has the order no. 000-0AA00.

**Coding pins**





*Please note that a coding pin cannot be installed on a 16x periphery module! Here you have to make sure that the associated terminal block is plugged again when the electronics unit is replaced.*

There is the possibility to fix the assignment of electronic and terminal module. Here coding pins (order number 000-0AC00) can be used. The coding pin consists of a coding jack and a coding plug. By combining electronic and terminal module with coding pin, the coding jack remains in the electronic module and the coding plug in the terminal module. This ensures that after replacing the electronic module just another electronic module can be plugged with the same encoding.

**Spare parts**

The following spare parts are available for the System SLIO:

Spare part	Order no.	Description	Packaging unit
	092-9BH00	Terminal block for System SLIO 16x periphery module.	5 pieces
	092-9BK00	Connector for System SLIO CPU 013C.	5 pieces



**CAUTION**

Please note that you may only use the spare parts with Yaskawa modules. Use with third-party modules is not allowed!

### 2.2.4 Hardware revision

#### Hardware revision on the front

- The hardware revision is printed on every System SLIO module.
- Since a System SLIO 8x peripheral module consists of a terminal and electronic module, you will find a hardware revision printed on each of them.
- Authoritative for the hardware revision of a System SLIO module is the hardware revision of the electronic module. This is located under the labeling strip of the corresponding electronic module.
- Depending on the module type, there are the following 2 variants e.g. to indicate hardware revision 1:
  - With current labelling there is a 1 on the front.
  - With earlier labelling, the 1 is marked with 'X' on a number grid.

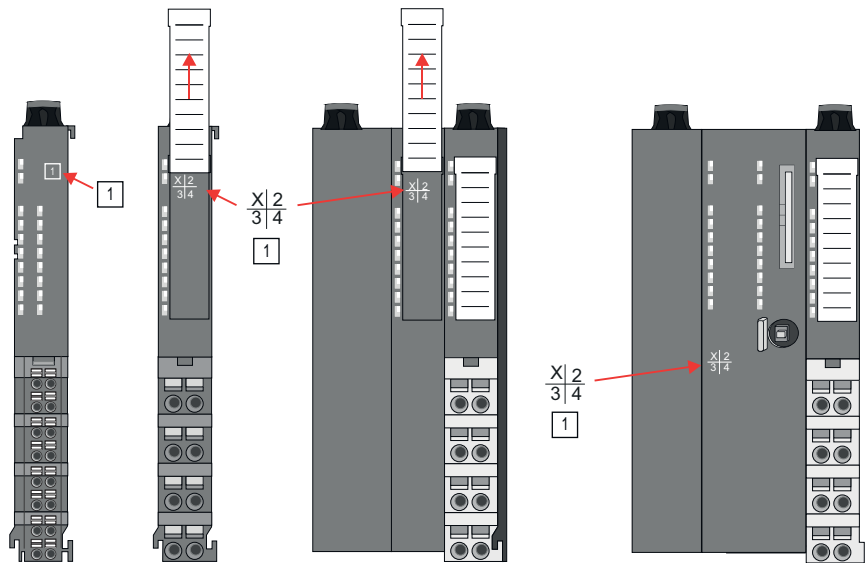

#### Hardware revision via web server

On the CPUs and some bus couplers, you can check the hardware revision 'HW Revision' via the integrated web server.

## 2.3 Dimensions

### CPU 01xC

All dimensions are in mm.

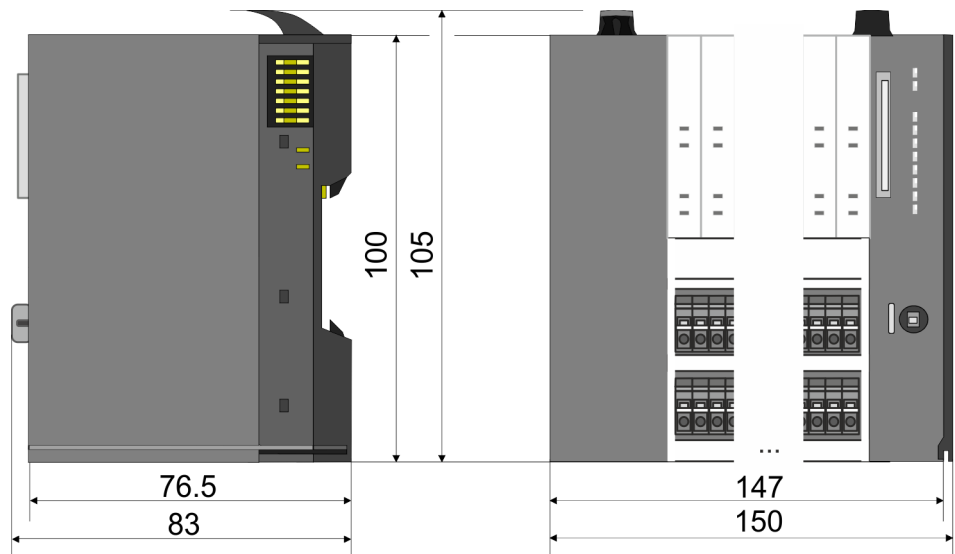

Dimensions

CPU 01x

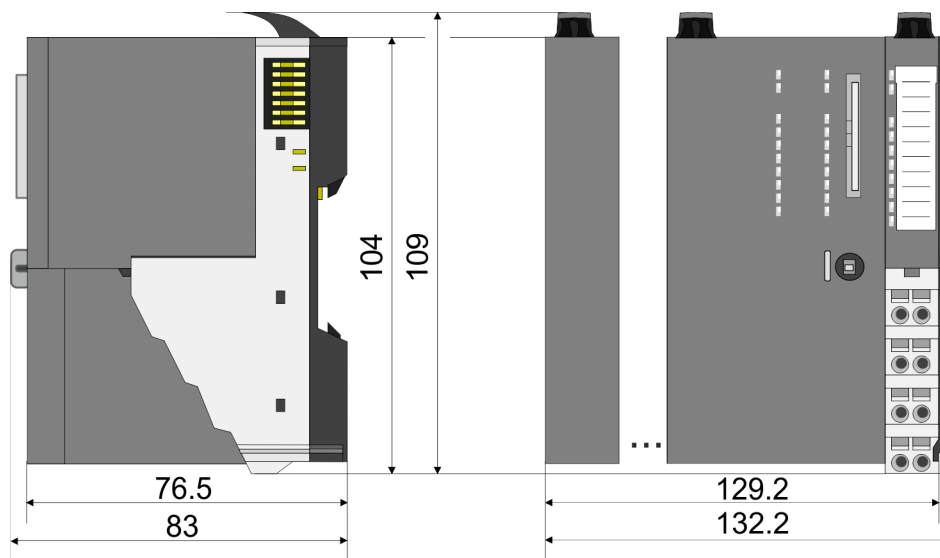

Bus coupler and line extension slave

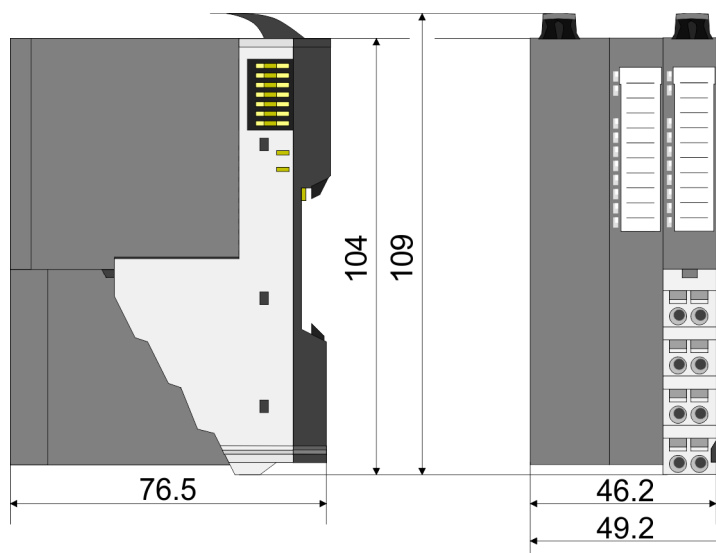

Line extension master

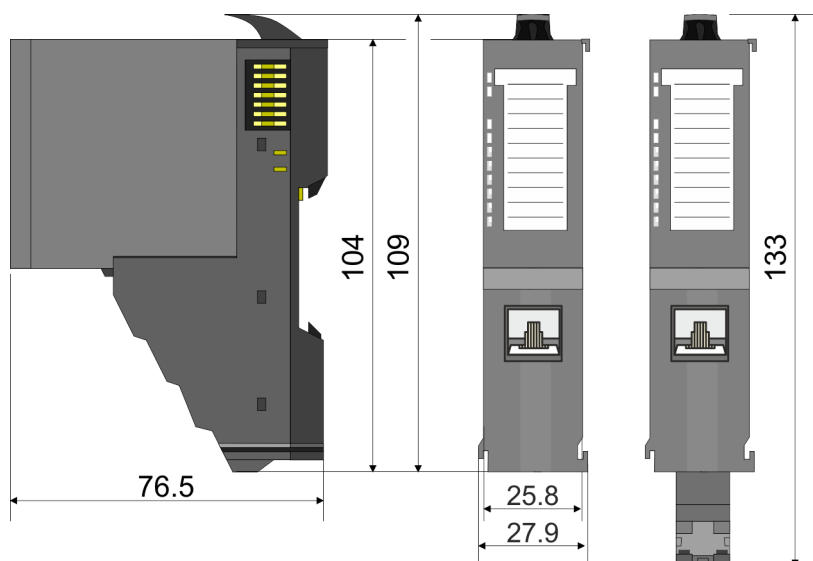



8x periphery module

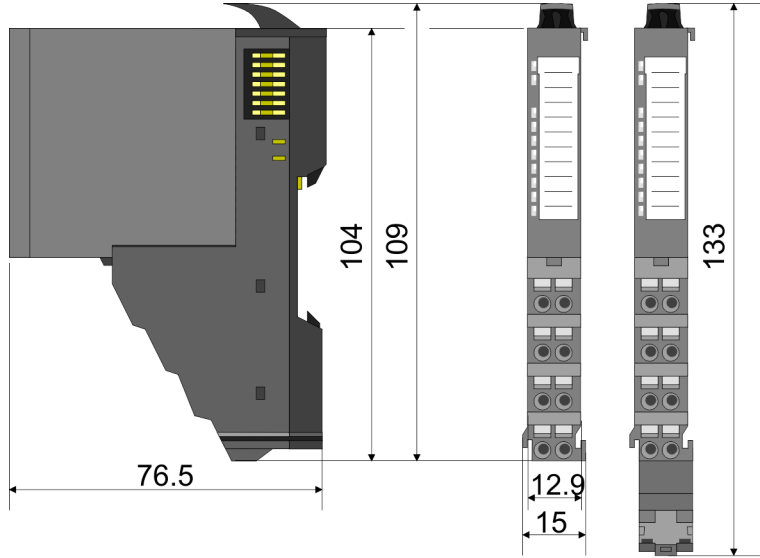

Electronic module

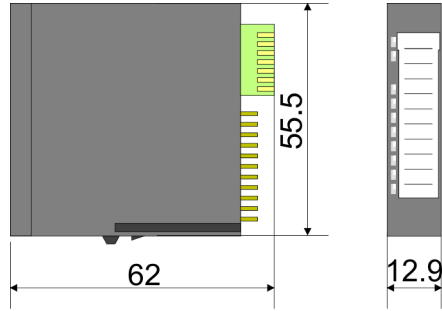

16x periphery module

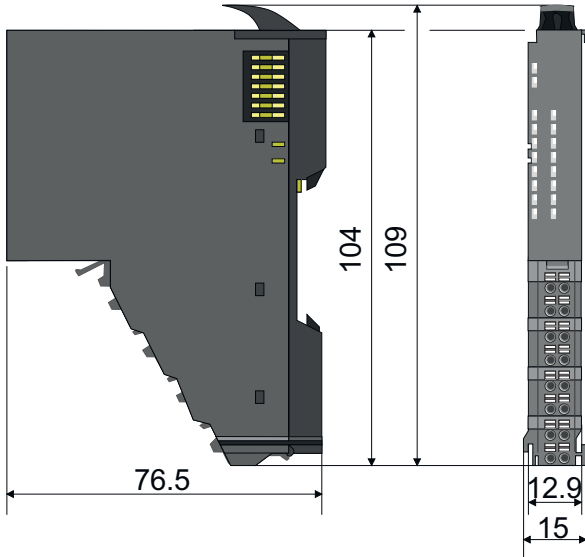

## 2.4 Mounting 8x periphery modules



**CAUTION**

**Requirements for UL compliance use**

- Use for power supply exclusively SELV/PELV power supplies.
- The System SLIO must be installed and operated in a housing according to IEC 61010-1 9.3.2 c).



**CAUTION**

**Danger of injury from electrical shock and damage to the unit!**

Put the System SLIO in a safe, powered down state before starting installation, disassembly or wiring of the System SLIO modules!

There is a locking lever at the top side of the module. For mounting and demounting this locking lever is to be turned upwards until this engages. For mounting place the module to the module installed before and push the module to the mounting rail guided by the strips at the upper and lower side of the module. The module is fixed to the mounting rail by pushing downward the locking lever. The modules may either separately be mounted to the mounting rail or as block. Here is to be considered that each locking lever is opened. The modules are each installed on a mounting rail. The electronic and power section supply are connected via the backplane bus. Up to 64 modules may be mounted. Please consider here that the sum current of the electronic power supply does not exceed the maximum value of 3A. By means of the power module 007-1AB10 the current of the electronic power supply may be expanded accordingly.

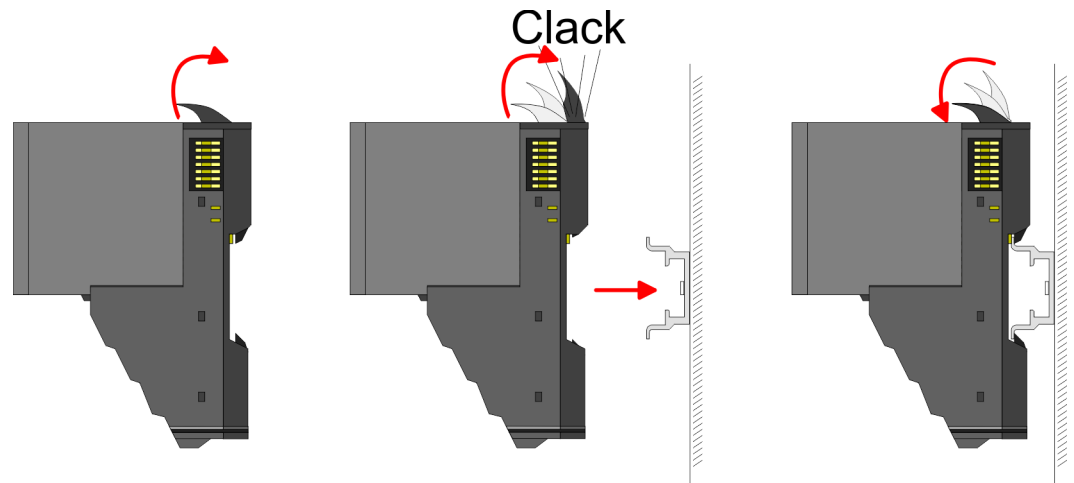

**Terminal and electronic module**

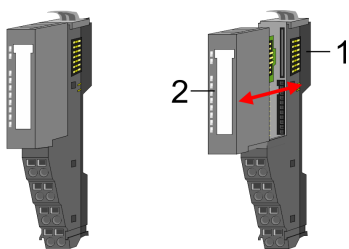

Each periphery module consists of a *terminal* and an *electronic module*.

- 1 Terminal module
- 2 Electronic module

For the exchange of a electronic module, the electronic module may be pulled forward after pressing the unlocking lever at the lower side of the module. For installation plug the electronic module guided by the strips at the lower side until this engages audible to the terminal module.

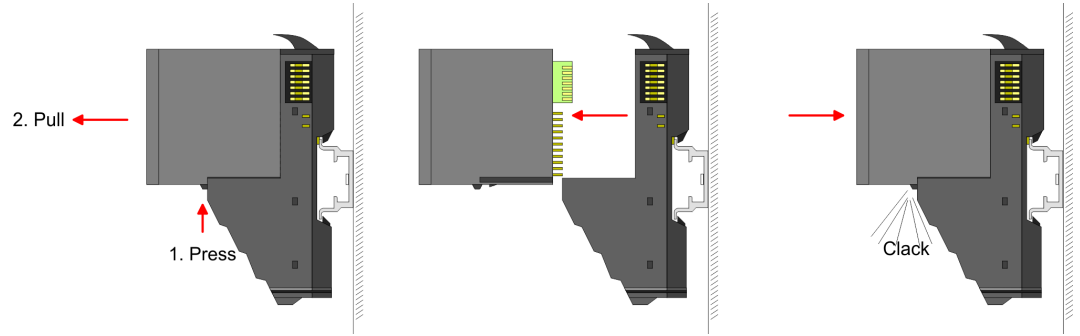

**Coding**



There is the possibility to fix the assignment of electronic and terminal module. Here coding pins (order number 000-0AC00) can be used. The coding pin consists of a coding jack and a coding plug. By combining electronic and terminal module with coding pin, the coding jack remains in the electronic module and the coding plug in the terminal module. This ensures that after replacing the electronics module just another electronic module can be plugged with the same encoding.

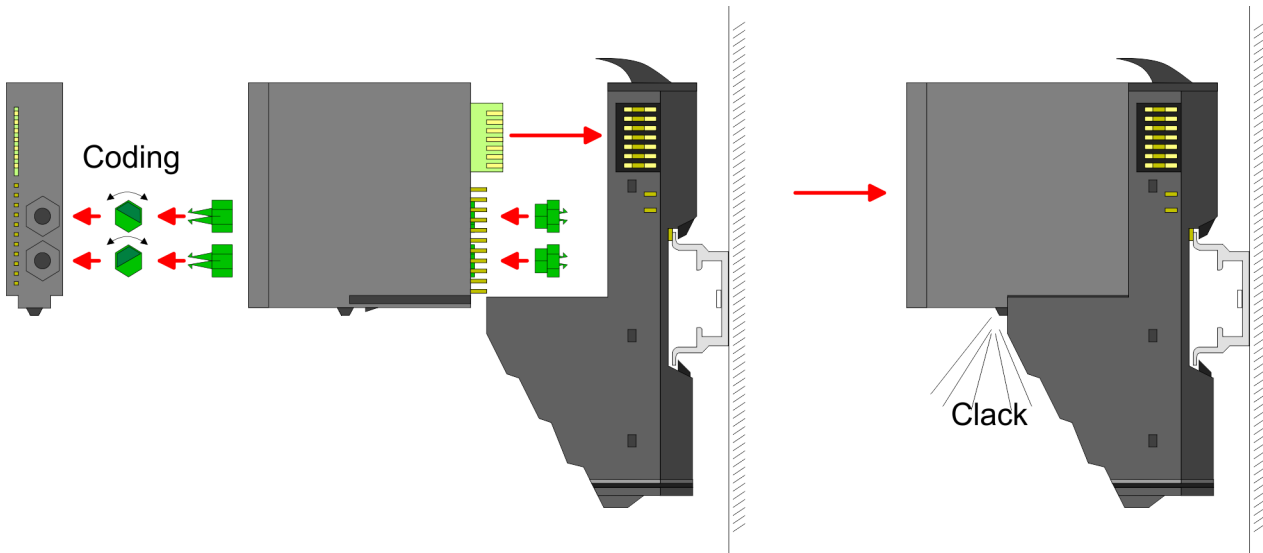

Each electronic module has on its back 2 coding sockets for coding jacks. Due to the characteristics, with the coding jack 6 different positions can be plugged, each. Thus there are 36 possible combinations for coding with the use of both coding sockets.

1. Plug, according to your coding, 2 coding jacks in the coding sockets of your electronic module until they lock
2. Now plug the according coding plugs into the coding jacks.
3. To fix the coding put both the electronic and terminal module together until they lock



**CAUTION**

Please consider that when replacing an already coded electronic module, this is always be replaced by an electronic module with the same coding.

Even with an existing coding on the terminal module, you can plug an electronic module without coding. The user is responsible for the correct usage of the coding pins. Yaskawa assumes no liability for incorrectly attached electronic modules or for damages which arise due to incorrect coding!

Mounting 8x periphery modules

Mounting periphery modules

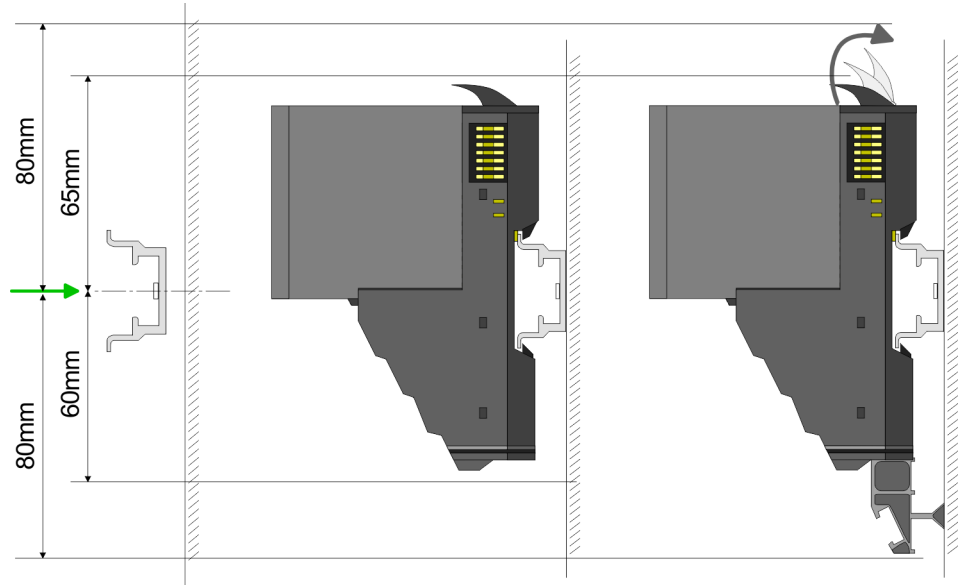

1. ➤ Mount the mounting rail! Please consider that a clearance from the middle of the mounting rail of at least 80mm above and 60mm below, respectively 80mm by deployment of shield bus carriers, exist.
2. ➤ Mount your head module such as CPU or field bus coupler.
3. ➤ Before mounting the periphery modules you have to remove the bus cover at the right side of the head module by pulling it forward. Keep the cover for later mounting.

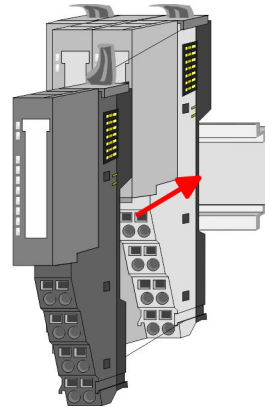
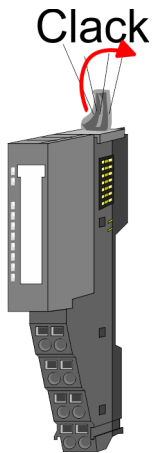

4. ➤ For mounting turn the locking lever of the module upwards until it engages.
5. ➤ For mounting place the module to the module installed before and push the module to the mounting rail guided by the strips at the upper and lower side of the module.
6. ➤ Turn the locking lever of the periphery module downward, again.

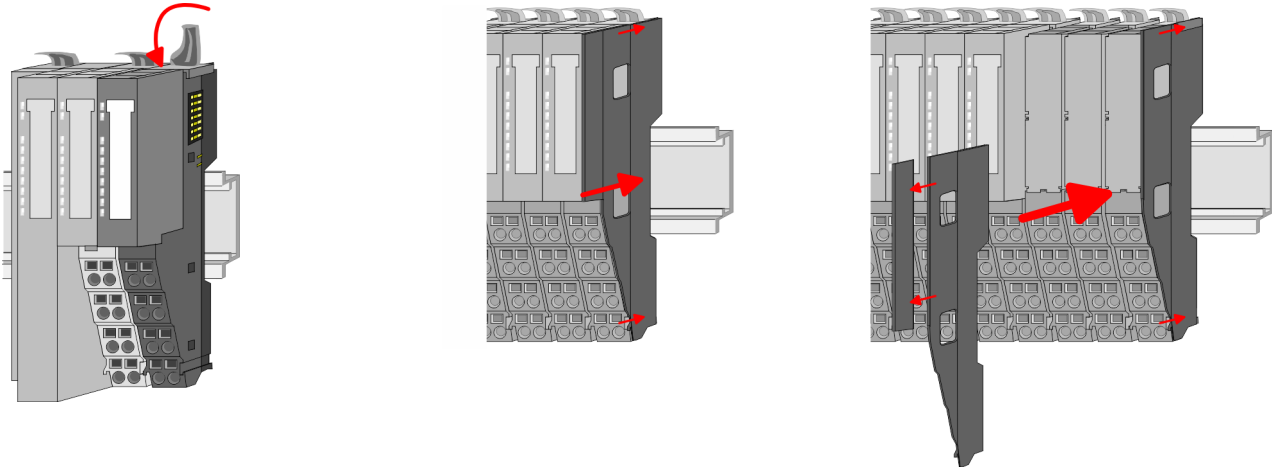

7. After mounting the whole system, to protect the backplane bus connectors at the last module you have to mount the bus cover, now. If the last module is a clamp module, for adaptation the upper part of the bus cover is to be removed.

## 2.5 Mounting 16x periphery modules



### CAUTION

#### Requirements for UL compliance use

- Use for power supply exclusively SELV/PELV power supplies.
- The System SLIO must be installed and operated in a housing according to IEC 61010-1 9.3.2 c).



### CAUTION

#### Danger of injury from electrical shock and damage to the unit!

Put the System SLIO in a safe, powered down state before starting installation, disassembly or wiring of the System SLIO modules!

There is a locking lever at the top side of the module. For mounting and demounting this locking lever is to be turned upwards until this engages. For mounting place the module to the module installed before and push the module to the mounting rail guided by the strips at the upper and lower side of the module. The module is fixed to the mounting rail by pushing downward the locking lever. The modules may either separately be mounted to the mounting rail or as block. Here is to be considered that each locking lever is opened. The modules are each installed on a mounting rail. The electronic and power section supply are connected via the backplane bus. Up to 64 modules may be mounted. Please consider here that the sum current of the electronic power supply does not exceed the maximum value of 3A. By means of the power module 007-1AB10 the current of the electronic power supply may be expanded accordingly.

Mounting 16x periphery modules

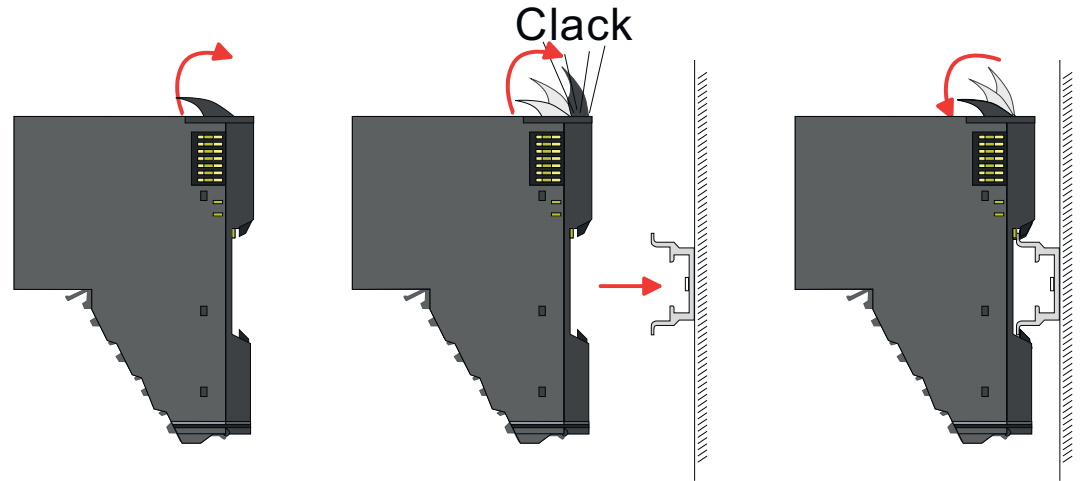

Electronic unit and terminal block

Each 16x periphery module consists of an *electronic unit* and a *terminal block*.

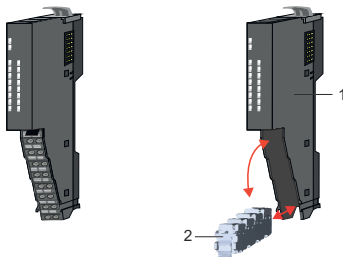

- 1 Electronic unit
- 2 Terminal block

To replace an electronic unit, you can push down and pull off the terminal block after releasing the lock. To mount the terminal block, place it horizontally on the lower side of the electronic unit and push it towards the electronic unit until it clicks into place.

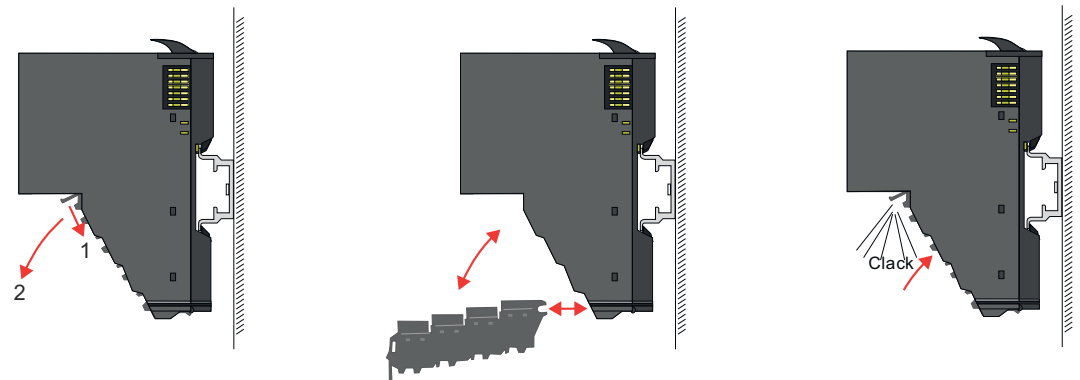

Mounting periphery module

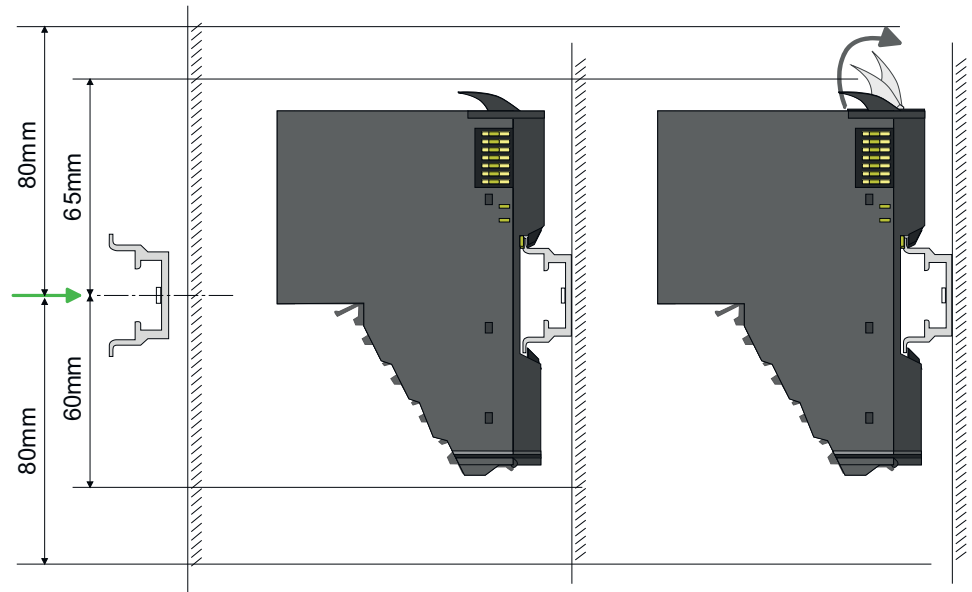

1. ➤ Mount the mounting rail! Please consider that a clearance from the middle of the mounting rail of at least 80mm above and 80mm below exist.
2. ➤ Mount your head module such as CPU or field bus coupler.
3. ➤ Before mounting the periphery modules you have to remove the bus cover at the right side of the head module by pulling it forward. Keep the cover for later mounting.

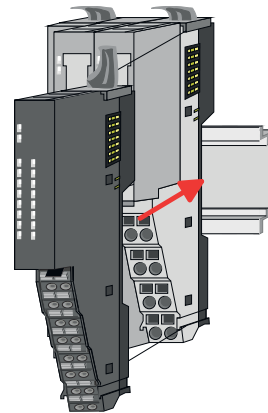
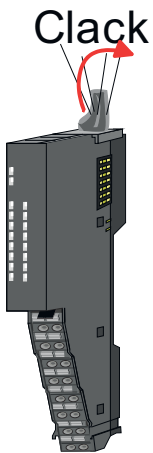

4. ➤ For mounting turn the locking lever of the module upwards until it engages.
5. ➤ For mounting place the module to the module installed before and push the module to the mounting rail guided by the strips at the upper and lower side of the module.
6. ➤ Turn the locking lever of the periphery module downward, again.

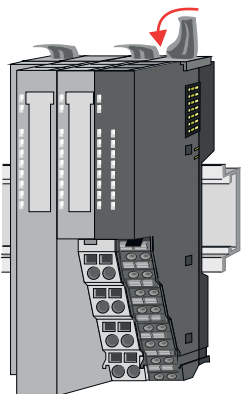

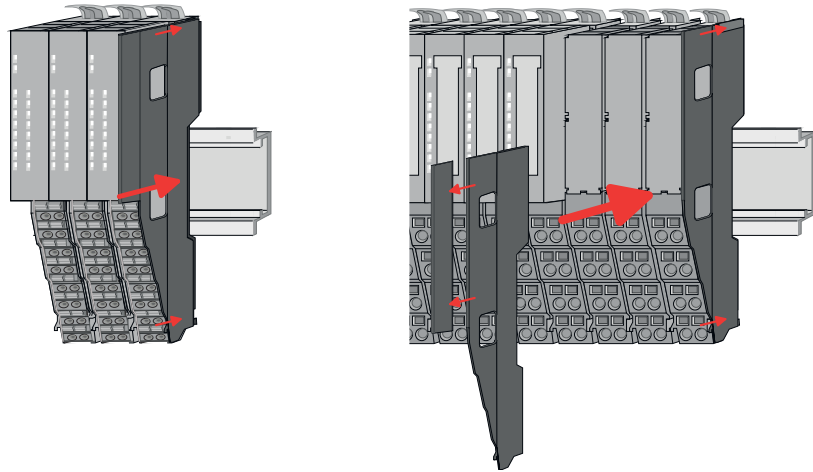

7. → After mounting the whole system, to protect the backplane bus connectors at the last module you have to mount the bus cover, now. If the last module is a clamp module, for adaptation the upper part of the bus cover is to be removed.

## 2.6 Wiring 8x periphery modules

### Terminal module terminals



**CAUTION**

**Do not connect hazardous voltages!**

If this is not explicitly stated in the corresponding module description, hazardous voltages are not allowed to be connected to the corresponding terminal module!



**CAUTION**

**Danger of injury from electrical shock and damage to the unit!**

Put the System SLIO in a safe, powered down state before starting installation, disassembly or wiring of the System SLIO modules!

- With wiring the terminal modules, terminals with spring clamp technology are used for wiring. The spring clamp technology allows quick and easy connection of your signal and supply lines. In contrast to screw terminal connections this type of connection is vibration proof.

### Data

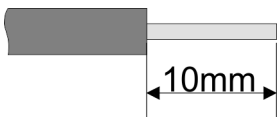

Please use copper wire only!

$U_{max}$	240V AC / 30V DC
$I_{max}$	10A
Cross section	0.08 ... 1.5mm <sup>2</sup> (AWG 28 ... 16)
Stripping length	10mm



Wiring procedure

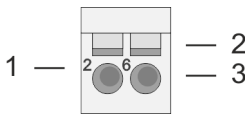

- 1 Pin number at the connector
- 2 Opening for screwdriver
- 3 Connection hole for wire

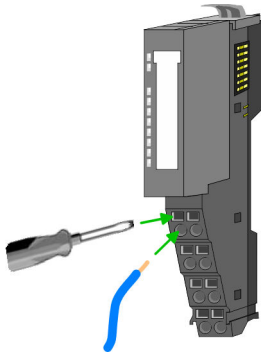
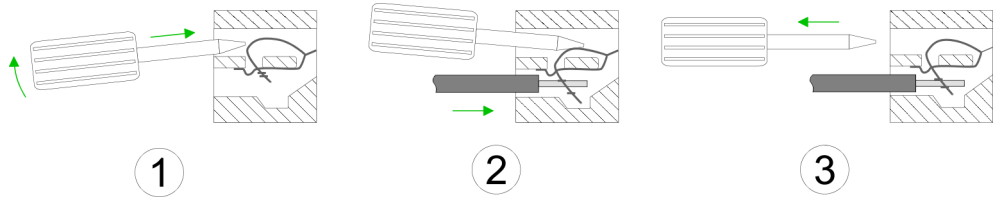

1. Insert a suited screwdriver at an angle into the square opening as shown. Press and hold the screwdriver in the opposite direction to open the contact spring.
2. Insert the stripped end of wire into the round opening. You can use wires with a cross section of 0.08mm<sup>2</sup> up to 1.5mm<sup>2</sup>
3. By removing the screwdriver, the wire is securely fixed via the spring contact to the terminal.

Shield attachment → [‘Shielding’...page 34](#)

## 2.7 Wiring 16x periphery modules

### Terminal block connectors



**CAUTION**

**Do not connect hazardous voltages!**

If this is not explicitly stated in the corresponding module description, hazardous voltages are not allowed to be connected to the corresponding terminal block!



**CAUTION**

**Danger of injury from electrical shock and damage to the unit!**

Put the System SLIO in a safe, powered down state before starting installation, disassembly or wiring of the System SLIO modules!

- The 16x periphery module has a removable terminal block for wiring.
- With the wiring of the terminal block a "push-in" spring-clip technique is used. This allows a quick and easy connection of your signal and supply lines.
- The clamping off takes place by means of a screwdriver.

### Data

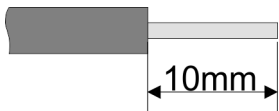

Please use copper wire only!

U <sub>max</sub>	30V DC
I <sub>max</sub>	10A
Cross section solid wire	0.25 ... 0.75mm <sup>2</sup>
Cross section with ferrule	0.14 ... 0.75mm <sup>2</sup>
AWG	24 ... 16
Stripping length	10mm

Wiring power modules

Wiring procedure



Insert wire

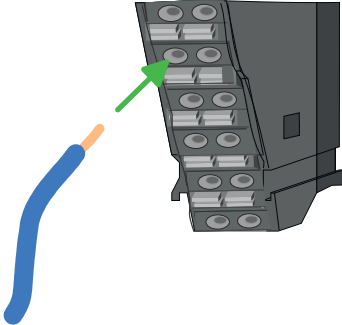

- 1 Release area
- 2 Connection hole for wire

The wiring happens without a tool.

1. Determine according to the casing labelling the connection position.
2. Insert through the round connection hole of the according contact your prepared wire until it stops, so that it is fixed.
  - ➔ By pushing the contact spring opens, thus ensuring the necessary contact pressure.

Remove wire

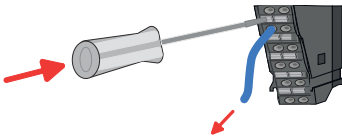

The wire is to be removed by means of a screwdriver with 2.5mm blade width.

1. Press with your screwdriver vertically at the release button.
  - ➔ The contact spring releases the wire.
2. Pull the wire from the round hole.

## 2.8 Wiring power modules

Terminal module terminals

Power modules are either integrated to the head module or may be installed between the periphery modules. With power modules, terminals with spring clamp technology are used for wiring. The spring clamp technology allows quick and easy connection of your signal and supply lines. In contrast to screw terminal connections this type of connection is vibration proof.

Data

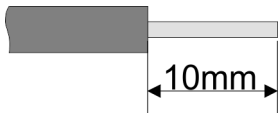

Please use copper wire only!

$U_{max}$  30V DC  
 $I_{max}$  10A  
 Cross section 0.08 ... 1.5mm<sup>2</sup> (AWG 28 ... 16)  
 Stripping length 10mm

Wiring procedure

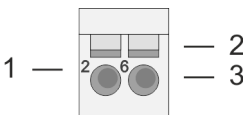

- 1 Pin number at the connector
- 2 Opening for screwdriver
- 3 Connection hole for wire



**CAUTION**

**Danger of injury from electrical shock and damage to the unit!**

Put the System SLIO in a safe, powered down state before starting installation, disassembly or wiring of the System SLIO modules!

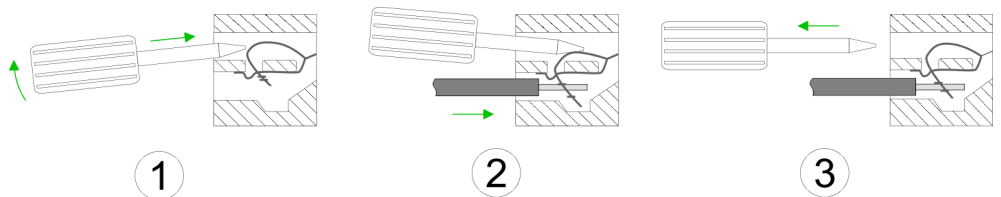

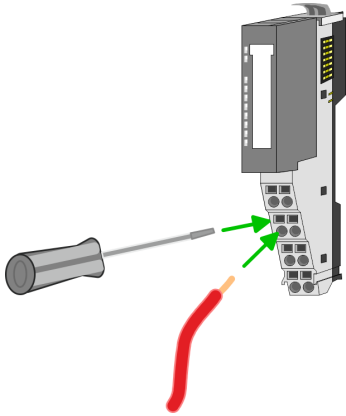

1. Insert a suited screwdriver at an angle into the square opening as shown. Press and hold the screwdriver in the opposite direction to open the contact spring.
2. Insert the stripped end of wire into the round opening. You can use wires with a cross section of 0.08mm<sup>2</sup> up to 1.5mm<sup>2</sup>
3. By removing the screwdriver, the wire is securely fixed via the spring contact to the terminal.

Standard wiring

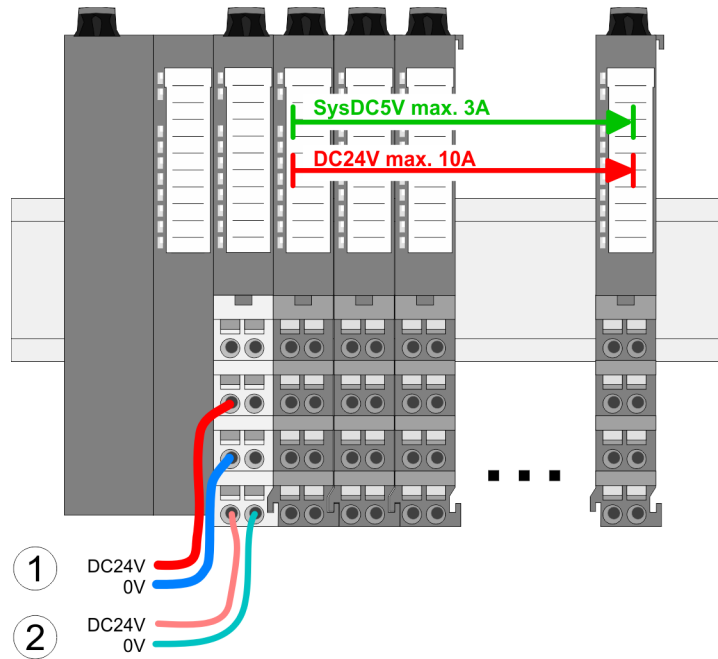

- (1) DC 24V for power section supply I/O area (max. 10A)
- (2) DC 24V for electronic power supply bus coupler and I/O area

PM - Power module

For wires with a core cross-section of 0.08mm<sup>2</sup> up to 1.5mm<sup>2</sup>.

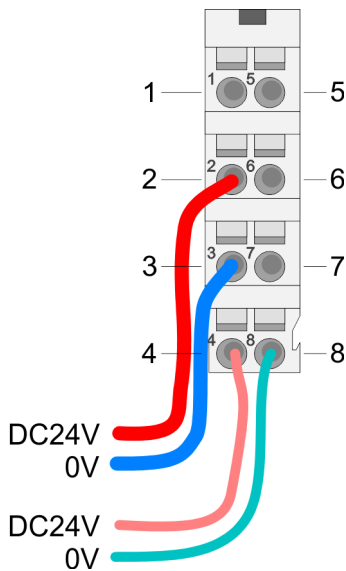

Pos.	Function	Type	Description
1	---	---	not connected
2	DC 24V	I	DC 24V for power section supply
3	0V	I	GND for power section supply
4	Sys DC 24V	I	DC 24V for electronic power supply
5	---	---	not connected
6	DC 24V	I	DC 24V for power section supply
7	0V	I	GND for power section supply
8	Sys 0V	I	GND for electronic power supply

I: Input



**CAUTION**

Since the power section supply is not internally protected, it is to be externally protected with a fuse, which corresponds to the maximum current. This means max. 10A is to be protected by a 10A fuse (fast) respectively by a line circuit breaker 10A characteristics Z and should be UL approved!



*The electronic power section supply is internally protected against higher voltage by fuse. The fuse is within the power module. If the fuse releases, its electronic module must be exchanged!*

**Fusing**

- The power section supply is to be externally protected with a fuse, which corresponds to the maximum current. This means max. 10A is to be protected with a 10A fuse (fast) respectively by a line circuit breaker 10A characteristics Z and should be UL approved!
  - For modules with positive logic (PNP), place the fuse on the positive connector.
  - For modules with negative logic (NPN), place the fuse on the negative connector.
  - For mixed logic, one fuse must be placed on the negative and one on the positive connector.
- It is recommended to externally protect the electronic power supply for head modules and I/O area with a 2A fuse (fast) respectively by a line circuit breaker 2A characteristics Z and should be UL approved.
- The electronic power supply for the I/O area of the power module 007-1AB10 should also be externally protected with a 1A fuse (fast) respectively by a line circuit breaker 1A characteristics Z and should be UL approved.

**State of the electronic power supply via LEDs**

After PowerON of the System SLIO the LEDs RUN respectively MF get on so far as the sum current does not exceed 3A. With a sum current greater than 3A the LEDs may not be activated. Here the power module with the order number 007-1AB10 is to be placed between the peripheral modules.

**Deployment of the power modules**

- If the 10A for the power section supply is no longer sufficient, you may use the power module with the order number 007-1AB00. So you have also the possibility to define isolated groups.
- The power module with the order number 007-1AB10 is to be used if the 3A for the electronic power supply at the backplane bus is no longer sufficient. Additionally you get an isolated group for the DC 24V power section supply with max. 4A.
- By placing the power module 007-1AB10 at the following backplane bus modules may be placed with a sum current of max. 2A. Afterwards a power module is to be placed again. To secure the power supply, the power modules may be mixed used.

**Power module 007-1AB00**

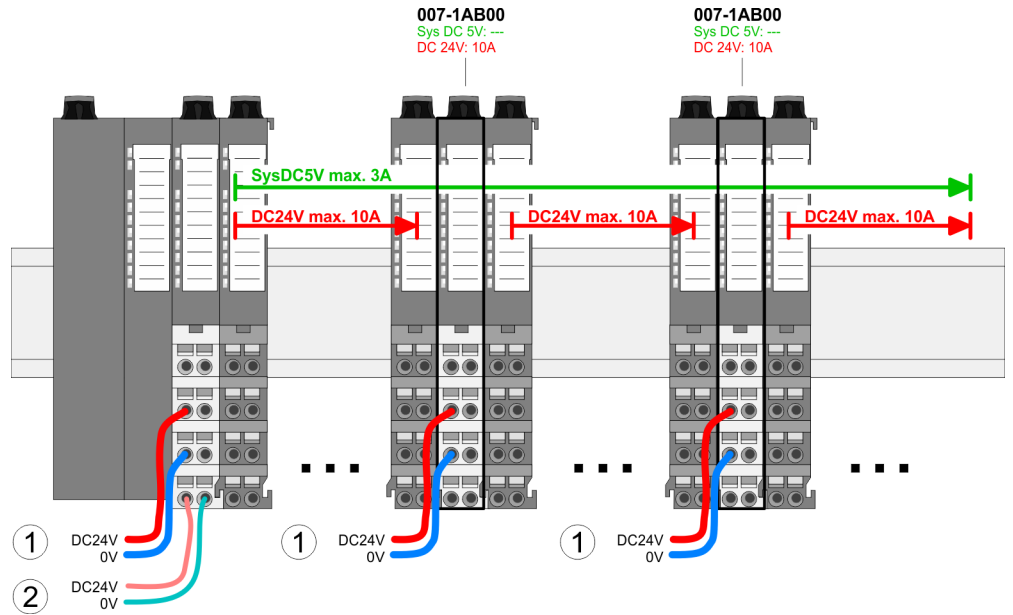

**Power module 007-1AB10**

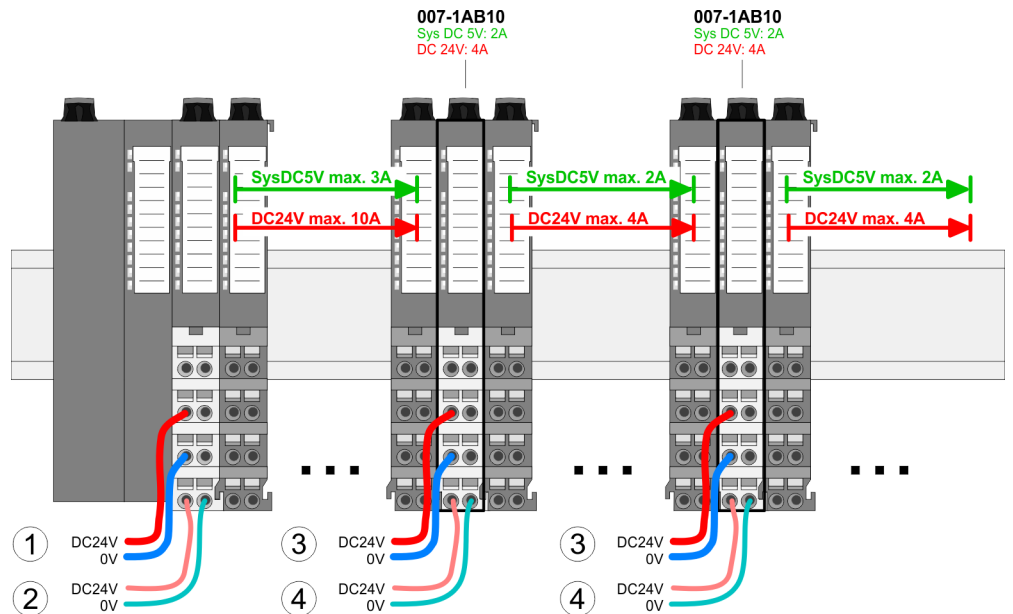

- (1) DC 24V for power section supply I/O area (max. 10A)
- (2) DC 24V for electronic power supply bus coupler and I/O area
- (3) DC 24V for power section supply I/O area (max. 4A)
- (4) DC 24V for electronic power supply I/O area

Shielding

2.9 Shielding

Overview

Shielding is required for interference-free signal transmission. This weakens electrical, magnetic or electromagnetic interference fields. To attach the shield the mounting of shield bus carriers are necessary. The shield bus carrier (available as accessory) serves to carry the shield bus to connect cable shields. → 'Installation guidelines'...page 44

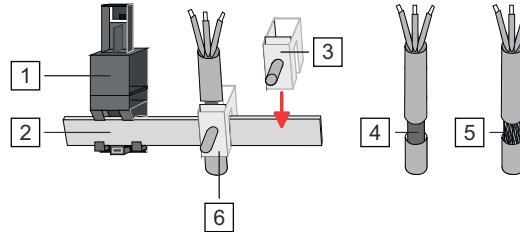

- 1 Shield bus carrier
- 2 Shield bus (10mm x 3mm)
- 3 Shield clamp
- 4 Cable shield with metal foil
- 5 Cable shield with wire mesh (close-meshed)
- 6 Cable shield mounted with shield clamp

Shield attachment

1. System SLIO head and 8x periphery modules have a carrier hole for the shield bus carrier. Push the shield bus carrier, until they engage into the module. With a flat mounting rail for adaptation to a flat mounting rail you may remove the spacer of the shield bus carrier.
2. Put your shield bus into the shield bus carrier.

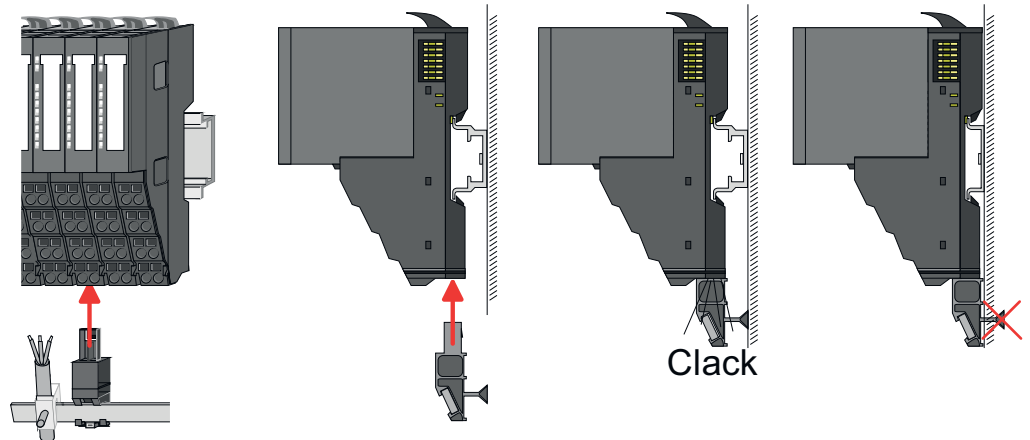

3. Attach the cables with the accordingly stripped cable screen and fix it by the shield clamp with the shield bus.
4. The shield bus must always be earthed. Keep all cable connections as short as possible. To earth the shield bus, connect a PE conductor to the shield bus via a shield clamp and screw it to the base plate as close as possible and with low impedance.

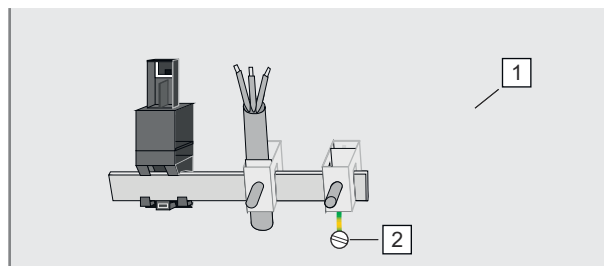

- 1 Base plate
- 2 PE conductor screwed to base plate

## 2.10 Demounting 8x periphery modules

### Proceeding

#### Exchange of an electronic module



#### CAUTION

Put the System SLIO in a safe, powered down state before starting disassembly!

1. Power-off your system.

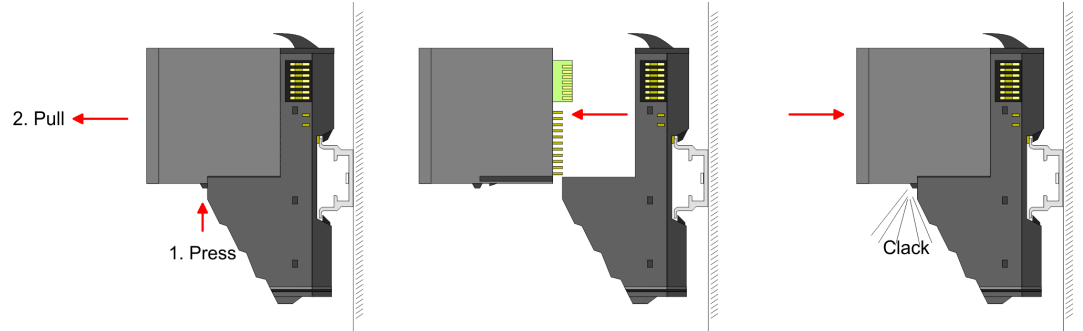

2. For the exchange of a electronic module, the electronic module may be pulled forward after pressing the unlocking lever at the lower side of the module.
3. For installation plug the new electronic module guided by the strips at the lower side until this engages to the terminal module.
  - ➔ Now you can bring your system back into operation.



#### Easy Maintenance

'Easy Maintenance' means the support for adding and removing electronic modules during operation without having to restart the system. If this is supported by your head module, you will find more detailed information on this in the "Deployment" chapter. ➔ 'Easy Maintenance'...page 40

#### Exchange of a periphery module

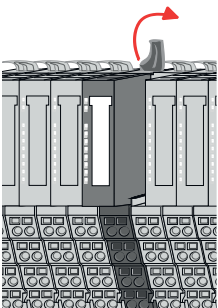
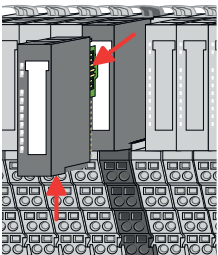

1. Power-off your system.
2. Remove if exists the wiring of the module.
- 3.



For demounting and exchange of a (head) module or a group of modules, due to mounting reasons you always have to remove the electronic module right beside. After mounting it may be plugged again.

- Press the unlocking lever at the lower side of the just mounted right module and pull it forward.
4. Turn the locking lever of the module to be exchanged upwards.

Demounting 8x periphery modules

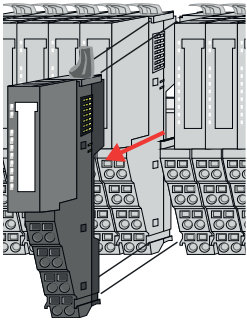

5. Pull the module.
6. For mounting turn the locking lever of the module to be mounted upwards.

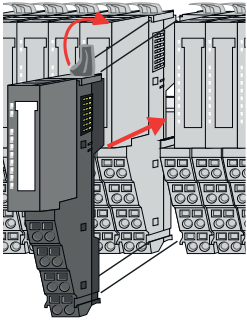

7. To mount the module put it to the gap between the both modules and push it, guided by the stripes at both sides, to the mounting rail.
8. Turn the locking lever downward, again.

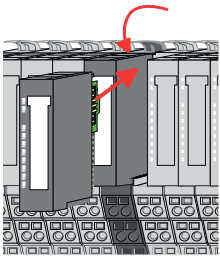

9. Plug again the electronic module, which you have removed before.
10. Wire your module.
  - ➔ Now you can bring your system back into operation.

Exchange of a module group

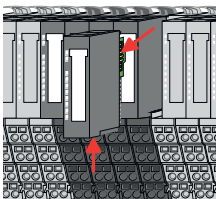

1. Power-off your system.
2. Remove if exists the wiring of the module group.
- 3.



*For demounting and exchange of a (head) module or a group of modules, due to mounting reasons you always have to remove the electronic module right beside. After mounting it may be plugged again.*

Press the unlocking lever at the lower side of the just mounted right module near the module group and pull it forward.

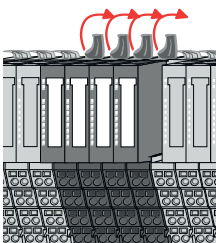

4. Turn all the locking lever of the module group to be exchanged upwards.

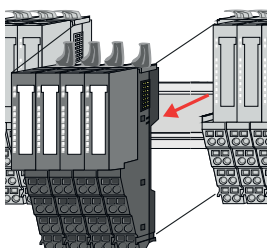

5. Pull the module group forward.
6. For mounting turn all the locking lever of the module group to be mounted upwards.



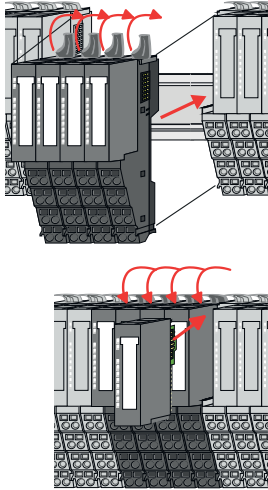

7. To mount the module group put it to the gap between the both modules and push it, guided by the stripes at both sides, to the mounting rail.
8. Turn all the locking lever downward, again.
9. Plug again the electronic module, which you have removed before.
10. Wire your module group.
  - ➔ Now you can bring your system back into operation.

## 2.11 Demounting 16x periphery modules

### Proceeding

#### Exchange of an electronic unit



#### CAUTION

Put the System SLIO in a safe, powered down state before starting disassembly!

1. Power-off your system.
2. To replace an electronic unit, you can push down and pull off the terminal block after releasing the lock.

To mount the terminal block, place it horizontally on the lower side of the electronic unit and push it towards the electronic unit until it clicks into place.

➔ Now you can bring your system back into operation.

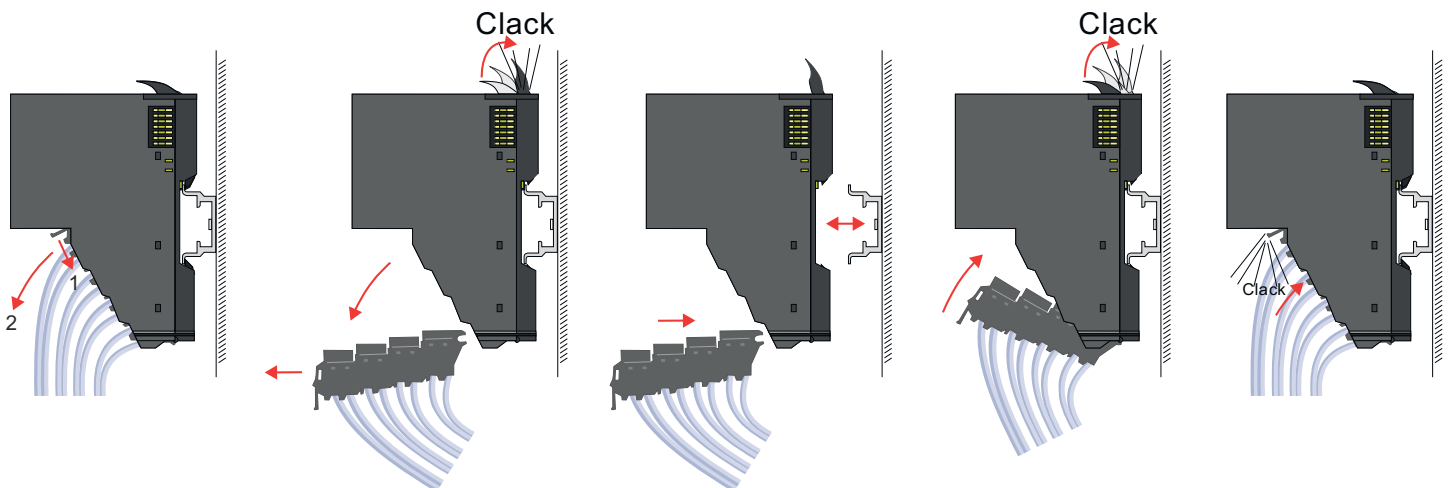

#### Exchange of a 16x periphery module

1. Power-off your system.
2. Remove if exists the wiring of the module respectively the wired terminal block.

Demounting 16x periphery modules

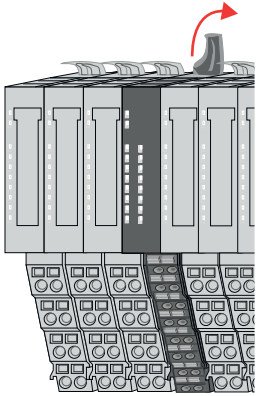

3. →



*In contrast to 8x periphery modules, you can directly demount and mount 16x periphery modules.*

Turn the locking lever of the module to be exchanged upwards.

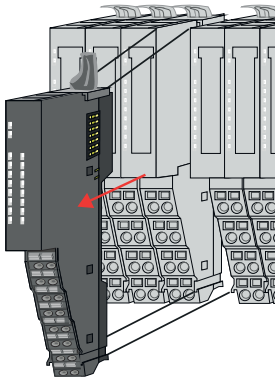

4. →

Pull the module.

5. →

For mounting turn the locking lever of the module to be mounted upwards.

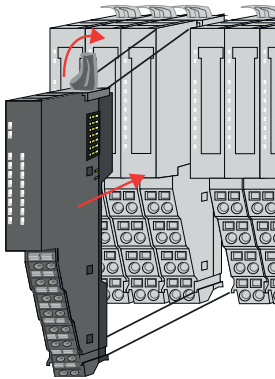

6. →

To mount the module put it to the gap between the both modules and push it, guided by the stripes at both sides, to the mounting rail.

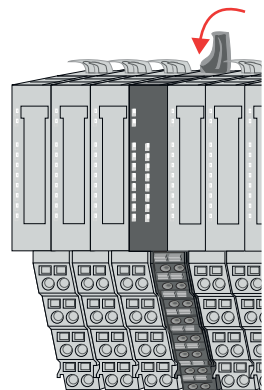

7. →

Turn the locking lever downward, again.

8. →

Wire your module respectively plug the wired terminal block again.

➔ Now you can bring your system back into operation.

**Exchange of a module group**

1. →

Power-off your system.

2. →

Remove if exists the wiring of the module group respectively the wired terminal blocks.

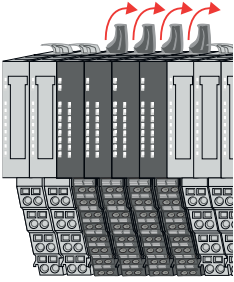

3. ➔



*In contrast to 8x periphery modules, you can directly demount and mount 16x periphery modules.*

Turn all the locking lever of the module group to be exchanged upwards.

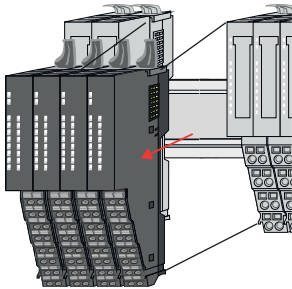

4. ➔ Pull the module group forward.

5. ➔ For mounting turn all the locking lever of the module group to be mounted upwards.

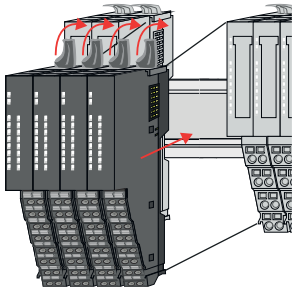

6. ➔ To mount the module group put it to the gap between the both modules and push it, guided by the stripes at both sides, to the mounting rail.

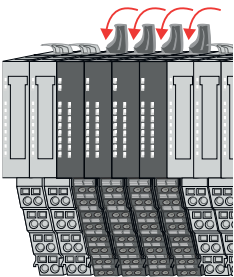

7. ➔ Turn all the locking lever downward, again.

8. ➔ Wire your module group respectively plug the wired terminal blocks again.

➔ Now you can bring your system back into operation.

## 2.12 Easy Maintenance

### Overview

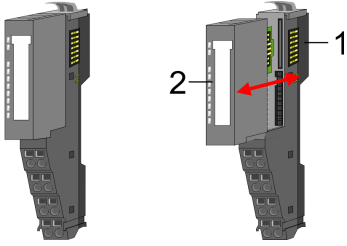

- 1 Terminal module
- 2 Electronic module

*Easy Maintenance* means the support for adding and removing an electronic module during operation without having to restart the system. Here the following behavior is shown by the example of a CPU:

- Electronic module is removed
  - The CPU detects a module failure on the backplane bus.
  - Diagnostic message *'System SLIO bus failure' (0x39D0)* is triggered.
  - OB 86 is called. If this is not available, the CPU switches to STOP otherwise it remains in RUN.
  - The SF LED of the CPU lights up.
  - The I/O data of all modules become invalid.
- Identical electronic module is plugged
  - The CPU detects the module return on the backplane bus.
  - The SF-LED of the CPU gets off.
  - All RUN LEDs on the modules get on and the MF LEDs get off.
  - Diagnostic message *'System SLIO bus recovery' (0x38D0)* is triggered.
  - OB 86 is called. If this is not available, the CPU switches to STOP otherwise it remains in RUN.
  - The I/O data of all modules become valid again.
- Wrong electronic module is plugged
  - The CPU detects the wrong module.
  - Diagnostic message *'System SLIO bus recovery, but expected configuration does not match actual configuration' (0x38D1)* is triggered.
  - The SF LED of the CPU remains on.
  - The MF LED of the wrong module flashes.
  - OB 86 is called. If this is not available, the CPU switches to STOP otherwise it remains in RUN.
  - With the exception of the wrong module, the I/O data of all modules become valid again.



### CAUTION

Please note that only electronic modules may be exchanged during operation! Replacing an 8x or 16x periphery module during operation can damage the module and the system!



Please note that the CPU switches to STOP, if there is no OB 86 configured when adding or removing System SLIO modules!

## 2.13 Trouble shooting - LEDs

### General

Each module has the LEDs RUN and MF on its front side. Errors or incorrect modules may be located by means of these LEDs.

In the following illustrations flashing LEDs are marked by ☼.

### Sum current of the electronic power supply exceeded

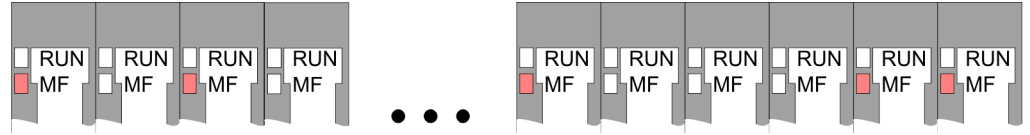

**Behavior:** After PowerON the RUN LED of each module is off and the MF LED of each module is sporadically on.

**Reason:** The maximum current for the electronic power supply is exceeded.

**Remedy:** As soon as the sum current of the electronic power supply is exceeded, always place the power module 007-1AB10. → ['Wiring power modules'...page 30](#)

### Error in configuration

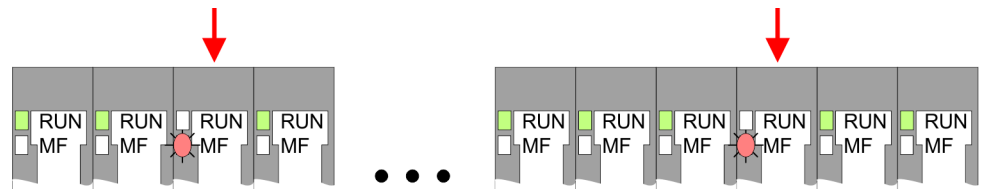

**Behavior:** After PowerON the MF LED of one module respectively more modules flashes. The RUN LED remains off.

**Reason:** At this position a module is placed, which does not correspond to the configured module.

**Remedy:** Match configuration and hardware structure.

### Module failure

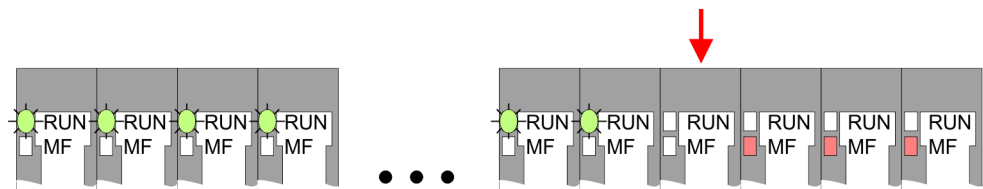

**Behavior:** After PowerON all of the RUN LEDs up to the defective module are flashing. With all following modules the MF LED is on and the RUN LED is off.

**Reason:** The module on the right of the flashing modules is defective.

**Remedy:** Replace the defective module.

## 2.14 Industrial security and installation guidelines

### 2.14.1 Industrial security in information technology

#### Latest version

This chapter can also be found as a guide '*Industrial IT Security*' in the '*Download Center*' of [www.yaskawa.eu.com](http://www.yaskawa.eu.com)

#### Hazards

The topic of data security and access protection has become increasingly important in the industrial environment. The increased networking of entire industrial systems to the network levels within the company together with the functions of remote maintenance have all served to increase vulnerability. Hazards can arise from:

- Internal manipulation such as technical errors, operating and program errors and deliberate program or data manipulation.
- External manipulation such as software viruses, worms and trojans.
- Human carelessness such as password phishing.

#### Precautions

The most important precautions to prevent manipulation and loss of data security in the industrial environment are:

- Encrypting the data traffic by means of certificates.
- Filtering and inspection of the traffic by means of VPN - "Virtual Private Networks".
- Identification of the user by "Authentication" via safe channels.
- Segmenting in protected automation cells, so that only devices in the same group can exchange data.
- Deactivation of unnecessary hardware and software.

#### Further Information

You can find more information about the measures on the following websites:

- Federal Office for Information Technology → [www.bsi.bund.de](http://www.bsi.bund.de)
- Cybersecurity & Infrastructure Security Agency → [us-cert.cisa.gov](http://us-cert.cisa.gov)
- VDI / VDE Society for Measurement and Automation Technology → [www.vdi.de](http://www.vdi.de)

### 2.14.1.1 Protection of hardware and applications

#### Precautions

- Do not integrate any components or systems into public networks.
  - Use VPN "Virtual Private Networks" for use in public networks. This allows you to control and filter the data traffic accordingly.
- Always keep your system up-to-date.
  - Always use the latest firmware version for all devices.
  - Update your user software regularly.
- Protect your systems with a firewall.
  - The firewall protects your infrastructure internally and externally.
  - This allows you to segment your network and isolate entire areas.
- Secure access to your plants via user accounts.
  - If possible, use a central user management system.
  - Create a user account for each user for whom authorization is essential.
  - Always keep user accounts up-to-date and deactivate unused user accounts.
- Secure access to your plants via secure passwords.
  - Change the password of a standard login after the first start.
  - Use strong passwords consisting of upper/lower case, numbers and special characters. The use of a password generator or manager is recommended.
  - Change the passwords according to the rules and guidelines that apply to your application.
- Deactivate inactive communication ports respectively protocols.
  - Only the communication ports that are used for communication should be activated.
  - Only the communication protocols that are used for communication should be activated.
- Consider possible defence strategies when planning and securing the system.
  - The isolation of components alone is not sufficient for comprehensive protection. An overall concept is to be drawn up here, which also provides defensive measures in the event of a cyber attack.
  - Periodically carry out threat assessments. Among others, a comparison is made here between the protective measures taken and those required.
- Limit the use of external storage media.
  - Via external storage media such as USB memory sticks or SD memory cards, malware can get directly into a system while bypassing a firewall.
  - External storage media or their slots must be protected against unauthorized physical access, e.g. by using a lockable control cabinet.
  - Make sure that only authorized persons have access.
  - When disposing of storage media, make sure that they are safely destroyed.
- Use secure access paths such as HTTPS or VPN for remote access to your plant.
- Enable security-related event logging in accordance with the applicable security policy and legal requirements for data protection.

### 2.14.1.2 Protection of PC-based software

#### Precautions

Since PC-based software is used for programming, configuration and monitoring, it can also be used to manipulate entire systems or individual components. Particular caution is required here!

- Use user accounts on your PC systems.
  - If possible, use a central user management system.
  - Create a user account for each user for whom authorization is essential.
  - Always keep user accounts up-to-date and deactivate unused user accounts.
- Protect your PC systems with secure passwords.
  - Change the password of a standard login after the first start.
  - Use strong passwords consisting of upper/lower case, numbers and special characters. The use of a password generator or manager is recommended.
  - Change the passwords according to the rules and guidelines that apply to your application.
- Enable security-related event logging in accordance with the applicable security policy and legal requirements for data protection.
- Protect your PC systems by security software.
  - Install virus scanners on your PC systems to identify viruses, trojans and other malware.
  - Install software that can detect phishing attacks and actively prevent them.
- Always keep your software up-to-date.
  - Update your operating system regularly.
  - Update your software regularly.
- Make regular backups and store the media at a safe place.
- Regularly restart your PC systems. Only boot from storage media that are protected against manipulation.
- Use encryption systems on your storage media.
- Perform security assessments regularly to reduce the risk of manipulation.
- Use only data and software from approved sources.
- Uninstall software which is not used.
- Disable unused services.
- Activate a password-protected screen lock on your PC systems.
- Always lock your PC systems as soon as you leave your PC workstation.
- Do not click any links that come from unknown sources. If necessary ask, e.g. on e-mails.
- Use secure access paths such as HTTPS or VPN for remote access to your PC system.

### 2.14.2 Installation guidelines

#### General

The installation guidelines contain information about the interference free deployment of a PLC system. There is the description of the ways, interference may occur in your PLC, how you can make sure the electromagnetic compatibility (EMC), and how you manage the isolation.

#### What does EMC mean?

Electromagnetic compatibility (EMC) means the ability of an electrical device, to function error free in an electromagnetic environment without being interfered respectively without interfering the environment.

The components are developed for the deployment in industrial environments and meets high demands on the EMC. Nevertheless you should project an EMC planning before installing the components and take conceivable interference causes into account.



**Possible interference causes**

Electromagnetic interferences may interfere your control via different ways:

- Electromagnetic fields (RF coupling)
- Magnetic fields with power frequency
- Bus system
- Power supply
- Protected earth conductor

Depending on the spreading medium (lead bound or lead free) and the distance to the interference cause, interferences to your control occur by means of different coupling mechanisms.

There are:

- galvanic coupling
- capacitive coupling
- inductive coupling
- radiant coupling

**Basic rules for EMC**

In the most times it is enough to take care of some elementary rules to guarantee the EMC. Please regard the following basic rules when installing your PLC.

- Take care of a correct area-wide grounding of the inactive metal parts when installing your components.
  - Install a central connection between the ground and the protected earth conductor system.
  - Connect all inactive metal extensive and impedance-low.
  - Please try not to use aluminium parts. Aluminium is easily oxidizing and is therefore less suitable for grounding.
- When cabling, take care of the correct line routing.
  - Organize your cabling in line groups (high voltage, current supply, signal and data lines).
  - Always lay your high voltage lines and signal respectively data lines in separate channels or bundles.
  - Route the signal and data lines as near as possible beside ground areas (e.g. suspension bars, metal rails, tin cabinet).
- Proof the correct fixing of the lead isolation.
  - Data lines must be shielded.
  - Analog lines must be shielded. When transmitting signals with small amplitudes the one sided laying of the isolation may be favourable.
  - Cables for frequency inverters, servo and stepper motors must be shielded.
  - Lay the line isolation extensively on an isolation/protected earth conductor rail directly after the cabinet entry and fix the isolation with cable clamps.
  - Make sure that the isolation/protected earth conductor rail is connected impedance-low with the cabinet.
  - Use metallic or metallised plug cases for isolated data lines.
- In special use cases you should appoint special EMC actions.
  - Consider to wire all inductivities with erase links.
  - Please consider luminescent lamps can influence signal lines.

- Create a homogeneous reference potential and ground all electrical operating supplies when possible.
  - Please take care for the targeted employment of the grounding actions. The grounding of the PLC serves for protection and functionality activity.
  - Connect installation parts and cabinets with your PLC in star topology with the isolation/protected earth conductor system. So you avoid ground loops.
  - If there are potential differences between installation parts and cabinets, lay sufficiently dimensioned potential compensation lines.

## Isolation of conductors

Electrical, magnetically and electromagnetic interference fields are weakened by means of an isolation, one talks of absorption. Via the isolation rail, that is connected conductive with the rack, interference currents are shunt via cable isolation to the ground. Here you have to make sure, that the connection to the protected earth conductor is impedance-low, because otherwise the interference currents may appear as interference cause.

When isolating cables you have to regard the following:

- If possible, use only cables with isolation tangle.
- The hiding power of the isolation should be higher than 80%.
- Normally you should always lay the isolation of cables on both sides. Only by means of the both-sided connection of the isolation you achieve high quality interference suppression in the higher frequency area. Only as exception you may also lay the isolation one-sided. Then you only achieve the absorption of the lower frequencies. A one-sided isolation connection may be convenient, if:
  - the conduction of a potential compensating line is not possible.
  - analog signals (some mV respectively  $\mu\text{A}$ ) are transferred.
  - foil isolations (static isolations) are used.
- With data lines always use metallic or metallised plugs for serial couplings. Fix the isolation of the data line at the plug rack. Do not lay the isolation on the PIN 1 of the plug bar!
- At stationary operation it is convenient to strip the insulated cable interruption free and lay it on the isolation/protected earth conductor line.
- To fix the isolation tangles use cable clamps out of metal. The clamps must clasp the isolation extensively and have well contact.
- Lay the isolation on an isolation rail directly after the entry of the cable in the cabinet.



### CAUTION

#### Please regard at installation!

At potential differences between the grounding points, there may be a compensation current via the isolation connected at both sides.

Remedy: Potential compensation line

## 2.15 General data for the System SLIO

Conformity and approval		
Conformity		
CE	2014/35/EU	Low Voltage Directive
	2014/30/EU	EMC Directive
RoHS (EU)	2011/65/EU	Restriction of the use of certain hazardous substances in electrical and electronic equipment
UKCA	2016 No. 1101	Electrical Equipment (Safety) Regulations
	2016 No. 1091	Electromagnetic Compatibility Regulations
RoHS (UK)	2012 No. 3032	Use of Certain Hazardous Substances
Approval		
Certifications	-	Refer to technical data

Protection of persons and device protection		
Type of protection	-	IP20
Electrical isolation		
to the field bus	-	electrically isolated
to the process level	-	electrically isolated
Insulation resistance	-	-
Insulation voltage to reference earth		
Inputs / outputs	-	AC / DC 50V, test voltage AC 500V
Protective measures	-	against short circuit

Environmental conditions to EN 61131-2		
Operation		
Horizontal installation hanging	EN 61131-2	0...+60°C
Horizontal installation lying	EN 61131-2	0...+55°C
Vertical installation	EN 61131-2	0...+50°C
Air humidity	EN 60068-2-30	RH1 (without condensation, rel. humidity 10...95%)
Pollution	EN 61131-2	Degree of pollution 2
Installation altitude max.	-	2000m
Mechanical		
Oscillation	EN 60068-2-6	1g, 9Hz ... 150Hz
Shock	EN 60068-2-27	15g, 11ms

Mounting conditions		
Mounting place	-	In the control cabinet
Mounting position	-	Horizontal and vertical

General data for the System SLIO > Use in difficult operating conditions

EMC	Standard	Comment	
Emitted interference	EN 61000-6-4	Class A (Industrial area)	
Noise immunity zone B	EN 61000-6-2	Industrial area	
		EN 61000-4-2	ESD 8kV at air discharge (degree of severity 3), 4kV at contact discharge (degree of severity 2)
		EN 61000-4-3	HF field immunity (casing) 80MHz ... 1000MHz, 10V/m, 80% AM (1kHz) 1.4GHz ... 6GHz, 3V/m, 80% AM (1kHz)
		EN 61000-4-6	HF conducted 150kHz ... 80MHz, 10V, 80% AM (1kHz)
		EN 61000-4-4	Burst
		EN 61000-4-5	Surge <sup>1</sup>

1) Due to the high-energetic single pulses with Surge an appropriate external protective circuit with lightning protection elements like conductors for lightning and overvoltage is necessary.

### 2.15.1 Use in difficult operating conditions



**Without additional protective measures, the products must not be used in locations with difficult operating conditions; e.g. due to:**

- dust generation
- chemically active substances (corrosive vapors or gases)
- strong electric or magnetic fields

## 2.16 System SLIO product variants for extended application range

The System SLIO product variants listed below only differ from the basic modules only in the extended temperature range and the use under condensation. All other data correspond to those of the basic modules. Information on structure and configuration can be found in the manuals for the basic modules in the 'Download Center' of [www.yaskawa.eu.com](http://www.yaskawa.eu.com)



*Please note that the product variants listed here may only be operated in combination with one another on the backplane bus! Mixed operation is not possible!*

Basic modules	Product variants	Description
053-1PN01	053-1PN01-C	IM - 053-1PN01 - interface module PROFINET
021-1BF00	021-1BF00-C	SM 021 - digital input - 8xDI - DC 24V
022-1BF00	022-1BF00-C	SM 022 - digital output - 8xDO - DC 24V 0.5A
031-1CD30	031-1CD30-C	SM 031 - analog input - 4xAI - 16bit 0 ... 10V
031-1BD80	031-1BD80-C	SM 031 - analog input - 4xAI - 16bit R/RTD
032-1CD30	032-1CD30-C	SM 032 - analog output - 4xAI - 16bit 0 ... 10V

### Environmental conditions according to EN 61131-2 for System SLIO basic modules

#### Climatic

Storage / transport	EN 60068-2-14	-25...+70°C
---------------------	---------------	-------------

#### Operation

Horizontal installation hanging	EN 61131-2	0...+60°C
Horizontal installation lying	EN 61131-2	0...+55°C
Vertical installation	EN 61131-2	0...+50°C
Air humidity	EN 60068-2-30	RH1 (without condensation, rel. humidity 10...95%)
Pollution	EN 61131-2	Degree of pollution 2

### Environmental conditions according to EN 61131-2 for System SLIO product variants

#### Climatic

Storage / transport	EN 60068-2-14	-25...+70°C
---------------------	---------------	-------------

#### Operation

Horizontal installation hanging	EN 61131-2	-25 ... + 60 ° C
Horizontal installation lying	EN 61131-2	-25...+55°C
Vertical installation	EN 61131-2	-25 ... + 50 ° C
Air humidity	EN 60068-2-30	RH1 (without condensation, rel. humidity 10...95%)
Climate	GS 95024-3-1:2010	Condensation
Pollution	EN 61131-2	Degree of pollution 2

## 3 Analog input

### 3.1 General

#### Cables for analog signals

For analog signals you should use screened cables to reduce interference. The cable screening should be grounded at both ends. If there are differences in the potential between the cable ends, there may occur a potential compensating current that could disturb the analog signals. In this case you should ground the cable screening only at one end.

#### Connecting sensors

Depending on the module the following sensors may be connected to the analog input modules:

- Current sensor
- Voltage sensor
- Resistance-type sensors
- Temperature sensors



*Please take care of the correct polarity when installing the sensors!  
Please install short circuits at non-used inputs by connecting the positive contact with the channel ground of the according channel.*

#### Parameterization

The parameterization via CPU, PROFIBUS and PROFINET happens by means of record sets (DS). The corresponding record set number may be found at the respective module description. Here also the indices (IX) respectively subindices (SX) for CANopen respectively EtherCAT are listed.

#### Diagnostic functions

The modules have diagnostics capability. The following errors can release a diagnostic:

- Error in parameterization
- Measuring range over-/underflow
- Wire break



#### **Alternated blinking of the channel error LEDs**

*The alternate blinking of the channel error LEDs of channel 0 and 1 indicates a watchdog error due to a system overload. Restart with a power cycle your system. If the error occurred again, check configuration and circuit and adjust them if necessary. If the error persists, please contact our support.*

## 3.2 Analog value

### Representation of analog values

Analog values are exclusively processed in a binary format. For this the analog module transforms every process signal into a digital value and transfers this as word. The analog values are displayed as a fixed-point number in the two's complement.

Resolu- tion	Analog value															
	High byte (byte 0)								Low byte (byte 1)							
Bit number	15	14	13	12	11	10	9	8	7	6	5	4	3	2	1	0
Value	SG	$2^{14}$	$2^{13}$	$2^{12}$	$2^{11}$	$2^{10}$	$2^9$	$2^8$	$2^7$	$2^6$	$2^5$	$2^4$	$2^3$	$2^2$	$2^1$	$2^0$
12Bit	SG	Measuring value												0	0	0
15Bit	SG	Measuring value														

### Resolution

With a resolution of 12bit plus sign bit, the not used low value positions (3bits) are filled with "0".

### Sign bit (SG)

Here it is essential:

- Bit 15 = "0": → positive value
- Bit 15 = "1": → negative value

### Behavior at error

As soon as a measured value exceeds the overdrive region respectively falls below the underdrive region, the following value is issued:

- Measuring value > end of overdrive region:  
32767 (7FFFh)
- Measuring value < end of underdrive region:  
-32768 (8000h)

At a parameterization error the value 32767 (7FFFh) is issued.

### 3.3 Measuring ranges and function numbers

#### General

In the following there are the measuring ranges with function number listed, which were supported by the corresponding analog module.

The here listed formulas allow you to transform an evaluated measuring value (digital value) to a value assigned to the measuring range and vice versa.

#### 3.3.1 Voltage

Meas. range Voltage -80 ... 80mV (funct. no.)	Voltage (U)	Decimal (D)	Hex	Range	Formulas
-80 ... 80mV Siemens S7 format (11h)	94.07mV	32511	7EFFh	overrange	$D = 27648 \cdot \frac{U}{80}$ $U = D \cdot \frac{80}{27648}$
	80mV	27648	6C00h	nominal range	
	0V	0	0000h		
	-80mV	-27648	9400h		
	-94.07mV	-32512	8100h	underrange	
-80 ... 80mV Siemens S5 format (21h)	100mV	20480	5000h	overrange	$D = 16384 \cdot \frac{U}{80}$ $U = D \cdot \frac{80}{16384}$
	80mV	16384	4000h	nominal range	
	0V	0	0000h		
	-80mV	-16384	C000h		
	-100mV	-20480	B000h	underrange	

Meas. range Voltage 0 ... 10V (funct. no.)	Voltage (U)	Decimal (D)	Hex	Range	Formulas
0 ... 10V Siemens S7 format (10h)	11.76V	32511	7EFFh	overrange	$D = 27648 \cdot \frac{U}{10}$ $U = D \cdot \frac{10}{27648}$
	10V	27648	6C00h	nominal range	
	5V	13824	3600h		
	0V	0	0000h		
	-1.76V	-4864	ED00h	underrange	
0 ... 10V Siemens S5 format (20h)	12.5V	20480	5000h	overrange	$D = 16384 \cdot \frac{U}{10}$ $U = D \cdot \frac{10}{16384}$
	10V	16384	4000h	nominal range	
	5V	8192	2000h		
	0V	0	0000h		
	-2V	-3277	F333h	underrange	



Meas. range Voltage ±10V (funct. no.)	Voltage (U)	Decimal (D)	Hex	Range	Formulas
±10V Siemens S7 format (12h)	11.76V	32511	7EFFh	overrange	$D = 27648 \cdot \frac{U}{10}$ $U = D \cdot \frac{10}{27648}$
	10V	27648	6C00h	nominal range	
	5V	13824	3600h		
	0V	0	0000h		
	-5V	-13824	CA00h		
	-10V	-27648	9400h		
	-11.76V	-32512	8100h	underrange	
±10V Siemens S5 format (22h)	12.5V	20480	5000h	overrange	$D = 16384 \cdot \frac{U}{10}$ $U = D \cdot \frac{10}{16384}$
	10V	16384	4000h	nominal range	
	5V	8192	2000h		
	0V	0	0000h		
	-5V	-8192	E000h		
	-10V	-16384	C000h		
	-12.5V	-20480	B000h	underrange	

Measuring ranges and function numbers &gt; Current

## 3.3.2 Current

Meas. range Current 0(4) ... 20mA (funct. no.)	Current (I)	Decimal (D)	Hex	Range	Formulas
0 ... 20mA Siemens S7 format (31h)	23.52mA	32511	7EFFh	overrange	$D = 27648 \cdot \frac{I}{20}$  $I = D \cdot \frac{20}{27648}$
	20mA	27648	6C00h	nominal range	
	10mA	13824	3600h		
	0mA	0	0000h		
	-3.52mA	-4864	ED00h	underrange	
0 ... 20mA Siemens S5 format (41h)	25.00mA	20480	5000h	overrange	$D = 16384 \cdot \frac{I}{20}$  $I = D \cdot \frac{20}{16384}$
	20mA	16384	4000h	nominal range	
	10mA	8192	2000h		
	0mA	0	0000h		
	-4,00mA	-3277	F333h	underrange	
4 ... 20mA Siemens S7 format (30h)	22.81mA	32511	7EFFh	overrange	$D = 27648 \cdot \frac{I-4}{16}$  $I = D \cdot \frac{16}{27648} + 4$
	20mA	27648	6C00h	nominal range	
	12mA	13824	3600h		
	4mA	0	0000h		
	1.19mA	-4864	ED00h	underrange	
4 ... 20mA Siemens S5 format (40h)	24.00mA	20480	5000h	overrange	$D = 16384 \cdot \frac{I-4}{16}$  $I = D \cdot \frac{16}{16384} + 4$
	20mA	16384	4000h	nominal range	
	12mA	8192	2000h		
	4mA	0	0000h		
	0.8mA	-3277	F333h	underrange	

Meas. range Current 0 ... 20mA / 4KM-Format (funct. no.)	Current (I)	Decimal (D)	Hex	Range	Formulas
0 ... 20mA 4KM format (3Fh)	20.457mA	4095	0FFFh	overrange	$D = 4000 \cdot \frac{I}{20}$  $I = D \cdot \frac{20}{4000}$
	20mA	4000	0FA0h	nominal range	
	10mA	2000	07D0h		
	0mA	0	0000h		
	---				

## 3.3.3 Resistance

Measuring range Resistance (funct. no.)	Measuring value	Signal range	Range
2 wire: PT100 (50h)	+1000°C	+10000	overrange
	-200 ... +850°C	-2000 ... +8500	nominal range
	-243°C	-2430	underrange
2 wire: PT1000 (51h)	+1000°C	+10000	overrange
	-200 ... +850°C	-2000 ... +8500	nominal range
	-243°C	-2430	underrange
2 wire: NI100 (52h)	+295°C	+2950	overrange
	-60 ... +250°C	-600 ... +2500	nominal range
	-105°C	-1050	underrange
2 wire: NI1000 (53h)	+295°C	+2950	overrange
	-60 ... +250°C	-600 ... +2500	nominal range
	-105°C	-1050	underrange
2 wire: NI120 <sup>1</sup> (54h)	+400°C	+4000	overrange
	-80 ... +320°C	-800 ... +3200	nominal range
	-100°C	-1000	underrange
3 wire: PT100 (58h)	+1000°C	+10000	overrange
	-200 ... +850°C	-2000 ... +8500	nominal range
	-243°C	-2430	underrange
3 wire: PT1000 (59h)	+1000°C	+10000	overrange
	-200 ... +850°C	-2000 ... +8500	nominal range
	-243°C	-2430	underrange
3 wire: NI100 (5Ah)	+295°C	+2950	overrange
	-60 ... +250°C	-600 ... +2500	nominal range
	-105°C	-1050	underrange
3 wire: NI1000 (5Bh)	+295°C	+2950	overrange
	-60 ... +250°C	-600 ... +2500	nominal range
	-105°C	-1050	underrange
3 wire: NI120 <sup>1</sup> (5Ch)	+400°C	+4000	overrange
	-80 ... +320°C	-800 ... +3200	nominal range
	-100°C	-1000	underrange
4 wire: PT100 (60h)	+1000°C	+10000	overrange
	-200 ... +850°C	-2000 ... +8500	nominal range
	-243°C	-2430	underrange
4 wire: PT1000 (61h)	+1000°C	+10000	overrange
	-200 ... +850°C	-2000 ... +8500	nominal range
	-243°C	-2430	underrange

Measuring ranges and function numbers &gt; Resistance

Measuring range Resistance (funct. no.)	Measuring value	Signal range	Range
4 wire: NI100 (62h)	+295°C	+2950	overrange
	-60 ... +250°C	-600 ... +2500	nominal range
	-105°C	-1050	underrange
4 wire: NI1000 (63h)	+295°C	+2950	overrange
	-60 ... +250°C	-600 ... +2500	nominal range
	-105°C	-1050	underrange
4 wire: NI120 <sup>1</sup> (64h)	+400°C	+4000	overrange
	-80 ... +320°C	-800 ... +3200	nominal range
	-100°C	-1000	underrange
2 wire: 0 ... 60Ω (70h)	---	---	overrange
	0 ... 60Ω	0 ... 32767	nominal range
	---	---	underrange
2 wire: 0 ... 600Ω (71h)	---	---	overrange
	0 ... 600Ω	0 ... 32767	nominal range
	---	---	underrange
2 wire: 0 ... 3000Ω (72h)	---	---	overrange
	0 ... 3000Ω	0 ... 32767	nominal range
	---	---	underrange
3 wire: 0 ... 60Ω (78h)	---	---	overrange
	0 ... 60Ω	0 ... 32767	nominal range
	---	---	underrange
3 wire: 0 ... 600Ω (79h)	---	---	overrange
	0 ... 600Ω	0 ... 32767	nominal range
	---	---	underrange
3 wire: 0 ... 3000Ω (7Ah)	---	---	overrange
	0 ... 3000Ω	0 ... 32767	nominal range
	---	---	underrange
4 wire: 0 ... 60Ω (80h)	---	---	overrange
	0 ... 60Ω	0 ... 32767	nominal range
	---	---	underrange
4 wire: 0 ... 600Ω (81h)	---	---	overrange
	0 ... 600Ω	0 ... 32767	nominal range
	---	---	underrange
4 wire: 0 ... 3000Ω (82h)	---	---	overrange
	0 ... 3000Ω	0 ... 32767	nominal range
	---	---	underrange
2 wire: 0 ... 60Ω	---	---	overrange

Measuring range Resistance (funct. no.)	Measuring value	Signal range	Range
(90h)	0 ... 60Ω	0 ... 6000	nominal range
	---	---	underrange
2 wire: 0 ... 600Ω (91h)	---	---	overrange
	0 ... 600Ω	0 ... 6000	nominal range
2 wire: 0 ... 3000Ω (92h)	---	---	underrange
	0 ... 3000Ω	0 ... 30000	nominal range
3 wire: 0 ... 60Ω (98h)	---	---	overrange
	0 ... 60Ω	0 ... 6000	nominal range
3 wire: 0 ... 600Ω (99h)	---	---	underrange
	0 ... 600Ω	0 ... 6000	nominal range
3 wire: 0 ... 3000Ω (9Ah)	---	---	overrange
	0 ... 3000Ω	0 ... 30000	nominal range
4 wire: 0 ... 60Ω (A0h)	---	---	underrange
	0 ... 60Ω	0 ... 6000	nominal range
4 wire: 0 ... 600Ω (A1h)	---	---	overrange
	0 ... 600Ω	0 ... 6000	nominal range
4 wire: 0 ... 3000Ω (A2h)	---	---	underrange
	0 ... 3000Ω	0 ... 30000	nominal range
2 wire: 0 ... 60Ω (D0h)	---	---	overrange
	70.55Ω	32511	overrange
2 wire: 0 ... 600Ω (D1h)	0 ... 60Ω	0 ... 27648	nominal range
	---	---	underrange
2 wire: 0 ... 3000Ω (D2h)	705.5Ω	32511	overrange
	0 ... 600Ω	0 ... 27648	nominal range
3 wire: 0 ... 60Ω (D8h)	---	---	underrange
	3528Ω	32511	overrange
	0 ... 3000Ω	0 ... 27648	nominal range
	---	---	underrange
	70.55Ω	32511	overrange
	0 ... 60Ω	0 ... 27648	nominal range

Measuring ranges and function numbers &gt; Resistance

Measuring range Resistance (funct. no.)	Measuring value	Signal range	Range
	---	---	underrange
3 wire: 0 ... 600Ω (D9h)	705.5Ω	32511	overrange
	0 ... 600Ω	0 ... 27648	nominal range
	---	---	underrange
3 wire: 0 ... 3000Ω (DAh)	3528Ω	32511	overrange
	0 ... 3000Ω	0 ... 27648	nominal range
	---	---	underrange
4 wire: 0 ... 60Ω (E0h)	70.55Ω	32511	overrange
	0 ... 60Ω	0 ... 27648	nominal range
	---	---	underrange
4 wire: 0 ... 600Ω (E1h)	705.5Ω	32511	overrange
	0 ... 600Ω	0 ... 27648	nominal range
	---	---	underrange
4 wire: 0 ... 3000Ω (E2h)	3528Ω	32511	overrange
	0 ... 3000Ω	0 ... 27648	nominal range
	---	---	underrange

1) Supported by 031-1BD80 from version 03V54 and 031-1LD80 from version 02V26.

The version information can be found on the outer packaging or via the website of the corresponding head module.

## 3.3.4 Temperature



Please note that the behavior of module 031-1CF90 has been changed outside the nominal range. More may be found in the module description.  
[↪ 300](#)

Measuring range Temperature (funct. no.)	Measuring value in °C (0.1°C/digit)	Measuring value in °F (0.1°F/digit)	Measuring value in K (0.1K/digit)	Range
Type J:	+14500	26420	17232	overrange
[Fe-Cu-Ni IEC]	-2100 ... +12000	-3460 ... 21920	632 ... 14732	nominal range
-210 ... +1200°C	---	---	---	underrange
-346 ... 2192°F				
63.2 ... 1473.2K				
(B0h: ext. comp. 0°C)				
(C0h: int. comp. 0°C)				
Type K:	+16220	29516	18952	overrange
[Ni-Cr-Ni]	-2700 ... +13720	-4540 ... 25016	0 ... 16452	nominal range
-270 ... +1372°C	---	---	---	underrange
-454 ... 2501.6°F				
0 ... 1645.2K				
(B1h: ext. comp. 0°C)				
(C1h: int. comp. 0°C)				
Type N:	+15500	28220	18232	overrange
[Ni-Cr-Si]	-2700 ... +13000	-4540 ... 23720	0 ... 15732	nominal range
-270 ... +1300°C	---	---	---	underrange
-454 ... 2372°F				
0 ... 1573.2K				
(B2h: ext. comp. 0°C)				
(C2h: int. comp. 0°C)				
Type R:	+20190	32766	22922	overrange
[PtRh-Pt]	-500 ... +17690	-580 ... 32162	2232 ... 20422	nominal range
-50 ... +1769°C	-1700	-2740	1032	underrange
-58 ... 3216.2°F				
223.2 ... 2042.2K				
(B3h: ext. comp. 0°C)				
(C3h: int. comp. 0°C)				
Type S:	+20190	32766	22922	overrange
[PtRh-Pt]	-500 ... +17690	-580 ... 32162	2232 ... 20422	nominal range
-50 ... +1769°C	-1700	-2740	1032	underrange
-58 ... 3216.2°F				

## Measuring ranges and function numbers &gt; Temperature

Measuring range Temperature (funct. no.)	Measuring value in °C (0.1°C/digit)	Measuring value in °F (0.1°F/digit)	Measuring value in K (0.1K/digit)	Range
223.2 ... 2042.2K (B4h: ext. comp. 0°C) (C4h: int. comp. 0°C)				
Type T: [Cu-Cu-Ni] -270 ... +400°C -454 ... 752°F 3.2 ... 673.2K (B5h: ext. comp. 0°C) (C5h: int. comp. 0°C)	+5400 -2700 ... +4000 ---	10040 -4540 ... 7520 ---	8132 32 ... 6732 ---	overrange nominal range underrange
Type B: [PtRh-PtRh] 0 ... +1820°C 32 ... 2786.5°F 273.2 ... 2093.2K (B6h: ext. comp. 0°C) (C6h: int. comp. 0°C)	+20700 0 ... +18200 -1200	32766 320 ... 27865 -1840	23432 2732 ... 20932 1532	overrange nominal range underrange
Type C: [WRe5-WRe26] 0 ... +2315°C 32 ... 2786.5°F 273.2 ... 2093.2K (B7h: ext. comp. 0°C) (C7h: int. comp. 0°C)	+25000 0 ... +23150 -1200	32766 320 ... 27865 -1840	23432 2732 ... 20932 1532	overrange nominal range underrange
Type E: [Ni-Cr - Cu-Ni ] -270 ... +1000°C -454 ... 1832°F 0 ... 1273.2K (B8h: ext. comp. 0°C) (C8h: int. comp. 0°C)	+12000 -2700 ... +10000 ---	21920 -4540 ... 18320 ---	14732 0 ... 12732 ---	overrange nominal range underrange
Type L: [Fe-Cu-Ni] -200 ... +900°C -328 ... 1652°F 73.2 ... 1173.2K (B9h: ext. comp. 0°C) (C9h: int. comp. 0°C)	+11500 -2000 ... +9000 ---	21020 -3280 ... 16520 ---	14232 732 ... 11732 ---	overrange nominal range underrange



### 3.4 031-1BB10 - AI 2x12Bit 0(4)...20mA - ISO

**Properties**

The electronic module has 2 inputs with parameterizable functions. The channels of the module are electrically isolated from the backplane bus. The sensor supplies are isolated from each other and via DC/DC converter from the DC 24V power supply.

- 2 galvanically separated analog inputs
- Integrated sensor supply for each channel max. 35mA, (short circuit to 39mA)
- Suited for sensors with 0 ... 20mA; 4 ... 20mA
- Interrupt and diagnostics function
- 12bit resolution

**Structure**

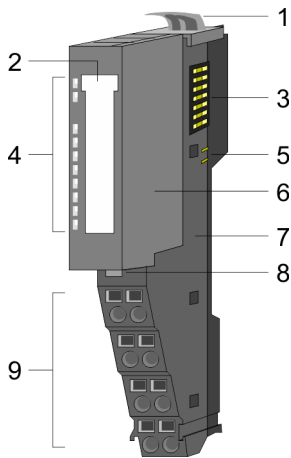

- 1 Locking lever terminal module
- 2 Labeling strip
- 3 Backplane bus
- 4 LED status indication
- 5 DC 24V power section supply
- 6 Electronic module
- 7 Terminal module
- 8 Locking lever electronic module
- 9 Terminal

**Status indication**

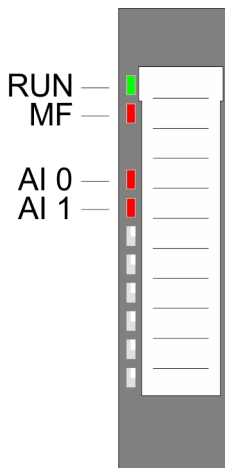

RUN	MF	AI x	Description
<input checked="" type="checkbox"/> green	<input checked="" type="checkbox"/> red	<input checked="" type="checkbox"/> red	
<input checked="" type="checkbox"/>	<input type="checkbox"/>	X	Bus communication is OK Module status is OK
<input checked="" type="checkbox"/>	<input checked="" type="checkbox"/>	X	Bus communication is OK Module status reports an error
<input type="checkbox"/>	<input checked="" type="checkbox"/>	X	Bus communication is not possible Module status reports an error
<input type="checkbox"/>	<input type="checkbox"/>	X	Error at bus power supply
X	<input checked="" type="checkbox"/>	X	Error in configuration → <a href="#">‘Trouble shooting - LEDs’...page 41</a>
<input checked="" type="checkbox"/>	<input type="checkbox"/>	<input checked="" type="checkbox"/>	Error channel x <ul style="list-style-type: none"> <li>■ Signal leaves measuring range</li> <li>■ Error in parameterization</li> <li>■ Overload/short circuit of the DC 24V_ISO</li> </ul>
not relevant: X			

031-1BB10 - AI 2x12Bit 0(4)...20mA - ISO

**Pin assignment**

For wires with a cross section of 0.08mm<sup>2</sup> up to 1.5mm<sup>2</sup>.

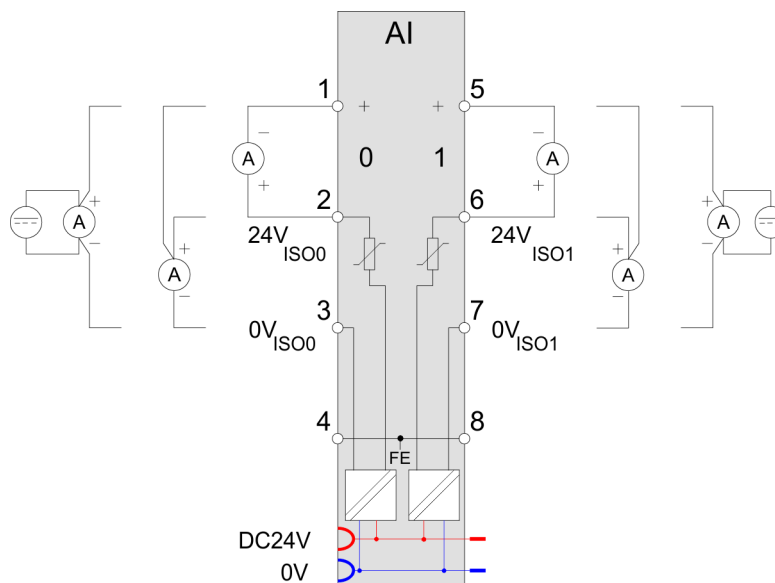
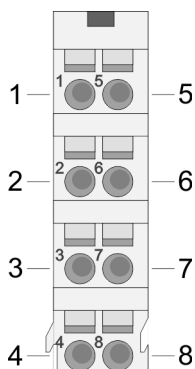

Pos.	Function	Type	Description
1	+AI 0	I	+ Channel 0
2	24V_ISO_0	O	DC 24V encoder supply Channel 0
3	0V_ISO_0	O	Ground channel 0
4	FE	---	Shield
5	AI 1	I	+ Channel 1
6	24V_ISO_1	O	DC 24V encoder supply Channel 1
7	0V_ISO_1	O	Ground Channel 1
8	FE	---	Shield

I: Input, O: Output

**In-/Output area**

At CPU, PROFIBUS and PROFINET the input respectively output area is embedded to the corresponding address area.

IX Index for access via CANopen with s = Subindex, depends on number and type of analog modules

SX Subindex for access via EtherCAT with Index 6000h + EtherCAT-Slot

More can be found in the according manual of your bus coupler.

**Input area**

Addr.	Name	Bytes	Function	IX	SX
+0	AI 0	2	Analog value channel 0	6401h/s	01h
+2	AI 1	2	Analog value channel 1	6401h/s+1	02h

**Output area**

No byte of the output area is used by the module.

## 3.4.1 Technical data

Order no.	031-1BB10
Type	SM 031 - Analog input
Module ID	0411 1543
<b>Current consumption/power loss</b>	
Current consumption from backplane bus	50 mA
Power loss	0.7 W
<b>Technical data analog inputs</b>	
Number of inputs	2
Cable length, shielded	200 m
Rated load voltage	DC 24 V
Current consumption from load voltage L+ (without load)	20 mA
Voltage inputs	-
Min. input resistance (voltage range)	-
Input voltage ranges	-
Operational limit of voltage ranges	-
Operational limit of voltage ranges with SFU	-
Basic error limit voltage ranges	-
Basic error limit voltage ranges with SFU	-
Destruction limit voltage	-
Current inputs	✓
Max. input resistance (current range)	60 Ω
Input current ranges	+4 mA ... +20 mA 0 mA ... +20 mA
Operational limit of current ranges	+/-0.5%
Operational limit of current ranges with SFU	-
Basic error limit current ranges	+/-0.3%
Radical error limit current ranges with SFU	-
Destruction limit current inputs (voltage)	max. 24V
Destruction limit current inputs (electrical current)	max. 40mA
Resistance inputs	-
Resistance ranges	-
Operational limit of resistor ranges	-
Operational limit of resistor ranges with SFU	-
Basic error limit	-
Basic error limit with SFU	-
Destruction limit resistance inputs	-
Resistance thermometer inputs	-
Resistance thermometer ranges	-

031-1BB10 - AI 2x12Bit 0(4)...20mA - ISO &gt; Technical data

Order no.	031-1BB10
Operational limit of resistance thermometer ranges	-
Operational limit of resistance thermometer ranges with SFU	-
Basic error limit thermoresistor ranges	-
Basic error limit thermoresistor ranges with SFU	-
Destruction limit resistance thermometer inputs	-
Thermocouple inputs	-
Thermocouple ranges	-
Operational limit of thermocouple ranges	-
Operational limit of thermocouple ranges with SFU	-
Basic error limit thermocouple ranges	-
Basic error limit thermocouple ranges with SFU	-
Destruction limit thermocouple inputs	-
Programmable temperature compensation	-
External temperature compensation	-
Internal temperature compensation	-
Temperature error internal compensation	-
Technical unit of temperature measurement	-
Resolution in bit	12
Measurement principle	successive approximation
Basic conversion time	1.15 ms all channels
Noise suppression for frequency	>80dB (UCM<20V)
<b>Status information, alarms, diagnostics</b>	
Status display	yes
Interrupts	yes, parameterizable
Process alarm	yes, parameterizable
Diagnostic interrupt	yes, parameterizable
Diagnostic functions	yes
Diagnostics information read-out	possible
Module state	green LED
Module error display	red LED
Channel error display	red LED per channel
<b>Isolation</b>	
Between channels	✓
Between channels of groups to	1
Between channels and backplane bus	✓
Between channels and power supply	✓
Max. potential difference between circuits	DC 75 V/ AC 50 V

<b>Order no.</b>	<b>031-1BB10</b>
Max. potential difference between inputs (Ucm)	DC 75 V/ AC 50 V
Max. potential difference between Mana and Mintern (Uiso)	-
Max. potential difference between inputs and Mana (Ucm)	DC 75 V/ AC 50 V
Max. potential difference between inputs and Mintern (Uiso)	DC 75 V/ AC 50 V
Max. potential difference between Mintern and outputs	-
Insulation tested with	DC 500 V
<b>Technical data encoder supply</b>	
Number of outputs	2
Output voltage (typ)	+24 V (-1.5 V)
Output voltage (rated value)	35 mA
Short-circuit protection	yes, electronic
Binding of potential	corresponding analog input
<b>Datasizes</b>	
Input bytes	4
Output bytes	0
Parameter bytes	20
Diagnostic bytes	20
<b>Housing</b>	
Material	PPE / PPE GF10
Mounting	Profile rail 35 mm
<b>Mechanical data</b>	
Dimensions (WxHxD)	12.9 mm x 109 mm x 76.5 mm
Net weight	65 g
Weight including accessories	65 g
Gross weight	79 g
<b>Environmental conditions</b>	
Operating temperature	0 °C to 60 °C
Storage temperature	-25 °C to 70 °C
<b>Certifications</b>	
UL certification	yes
KC certification	yes
UKCA certification	yes
ChinaRoHS certification	yes

SFU

Interference frequency suppression

### 3.4.2 Parameter data

DS Record set for access via CPU, PROFIBUS and PROFINET

IX Index for access via CANopen

SX Subindex for access via EtherCAT with Index 3100h + EtherCAT-Slot

More can be found in the according manual of your bus coupler.

Name	Bytes	Function	Default	DS	IX	SX
DIAG_EN	1	Diagnostics <sup>1</sup>	00h	00h	3100h	01h
SHORT_EN	1	Monitoring of sensor voltage <sup>1</sup>	00h	00h	3101h	02h
LIMIT_EN	1	Limit value monitoring <sup>1</sup>	00h	00h	3102h	03h
RES	1	reserved	00h	00h	3103h	04h
CH0FN	1	Function number channel 0	31h	80h	3104h	05h
CH0FO	1	Function option channel 0	00h	80h	3105h	06h
CH0UL	2	Upper limit value channel 0	7FFFh	80h	3106h...3107h	07h
CH0LL	2	Lower limit value channel 0	8000h	80h	3108h...3109h	08h
CH1FN	1	Function number channel 1	31h	81h	310Ah	09h
CH1FO	1	Function option channel 1	00h	81h	310Bh	0Ah
CH1UL	2	Upper limit value channel 1	7FFFh	81h	310Ch...310Dh	0Bh
CH1LL	2	Lower limit value channel 1	8000h	81h	310Eh...310Fh	0Ch

1) This record set may only be transferred at STOP state.

#### DIAG\_EN Diagnostic interrupt

Byte	Bit 7 ... 0
0	<ul style="list-style-type: none"> <li>■ Diagnostic interrupt               <ul style="list-style-type: none"> <li>- 00h: disabled</li> <li>- 40h: enabled</li> </ul> </li> </ul>

- Here you can enable respectively disable the diagnostic interrupt.

#### SHORT\_EN Monitoring sensor voltage

Byte	Bit 7 ... 0
0	<ul style="list-style-type: none"> <li>■ Bit 0: Monitoring of sensor voltage channel 0 (1: on)</li> <li>■ Bit 1: Monitoring of sensor voltage channel 1 (1: on)</li> <li>■ Bit 7 ... 2: reserved</li> </ul>

#### LIMIT\_EN Limit value monitoring

Byte	Bit 7 ... 0
0	<ul style="list-style-type: none"> <li>■ Bit 0: Limit value monitoring channel 0 (1: on)</li> <li>■ Bit 1: Limit value monitoring channel 1 (1: on)</li> <li>■ Bit 7 ... 2: reserved</li> </ul>

**CHxFN Function number  
channel x**

In the following there are the measuring ranges with corresponding function number listed, which were supported by the analog module. With FFh the corresponding channel is disabled and disabled the respective sensor supply. The formulas listed here allow you to transform an evaluated measuring value (digital value) to a value assigned to the measuring range (analog value) and vice versa.

Meas. range Current 0(4) ... 20mA (funct. no.)	Current (I)	Decimal (D)	Hex	Range	Formulas
0 ... 20mA Siemens S7 format (31h)	23.52mA	32511	7EFFh	overrange	$D = 27648 \cdot \frac{I}{20}$  $I = D \cdot \frac{20}{27648}$
	20mA	27648	6C00h	nominal range	
	10mA	13824	3600h		
	0mA	0	0000h		
	-3.52mA	-4864	ED00h	underrange	
0 ... 20mA Siemens S5 format (41h)	25.00mA	20480	5000h	overrange	$D = 16384 \cdot \frac{I}{20}$  $I = D \cdot \frac{20}{16384}$
	20mA	16384	4000h	nominal range	
	10mA	8192	2000h		
	0mA	0	0000h		
	-4,00mA	-3277	F333h	underrange	
4 ... 20mA Siemens S7 format (30h)	22.81mA	32511	7EFFh	overrange	$D = 27648 \cdot \frac{I-4}{16}$  $I = D \cdot \frac{16}{27648} + 4$
	20mA	27648	6C00h	nominal range	
	12mA	13824	3600h		
	4mA	0	0000h		
	1.19mA	-4864	ED00h	underrange	
4 ... 20mA Siemens S5 format (40h)	24.00mA	20480	5000h	overrange	$D = 16384 \cdot \frac{I-4}{16}$  $I = D \cdot \frac{16}{16384} + 4$
	20mA	16384	4000h	nominal range	
	12mA	8192	2000h		
	4mA	0	0000h		
	0.8mA	-3277	F333h	underrange	

Meas. range Current 0 ... 20mA / 4KM-Format (funct. no.)	Current (I)	Decimal (D)	Hex	Range	Formulas
0 ... 20mA 4KM format (3Fh)	20.457mA	4095	0FFFh	overrange	$D = 4000 \cdot \frac{I}{20}$  $I = D \cdot \frac{20}{4000}$
	20mA	4000	0FA0h	nominal range	
	10mA	2000	07D0h		
	0mA	0	0000h		
	---			underrange	

**CHxFO Function option  
channel x**

As function option for each channel a time constant  $\times 10\text{ms}$  may be preset for a low-pass filter. This is a second-order Butterworth filter. Here frequencies, which lie above the critical frequency, can be filtered. The setting for interference suppression (SFU) of 50Hz respectively 60Hz is 200ms respectively 170ms.

Range of values: 0 ... 250 (0 = deactivated)

The following diagram shows the transient behavior of the filter with a time constant of 500ms. Here the filter reaches the desired value after 1700ms for the first time.

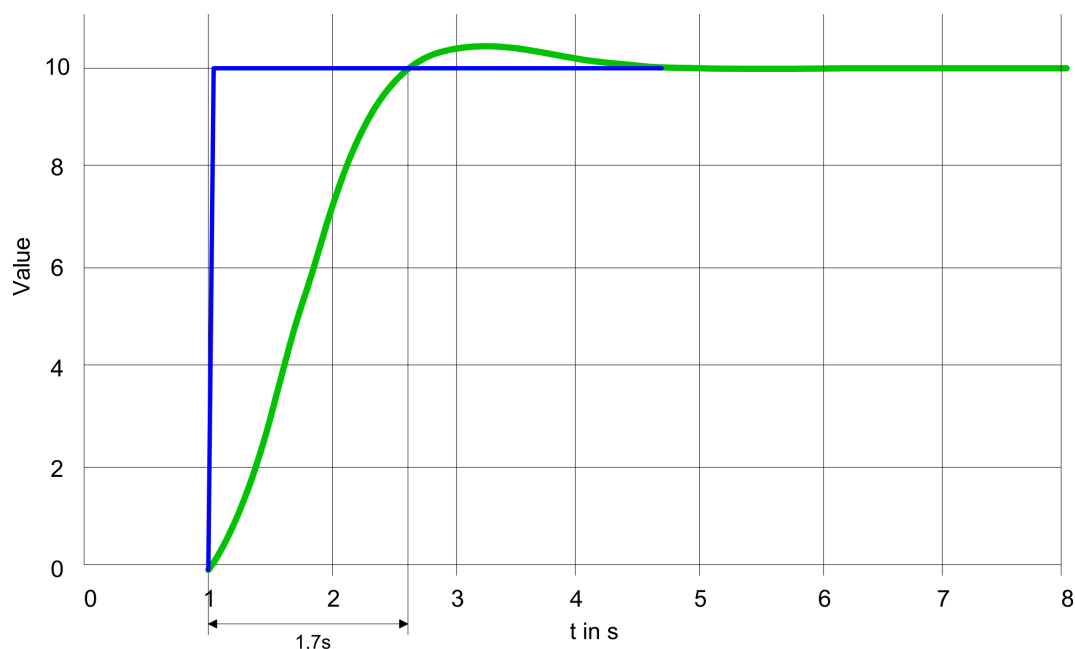
**CHxUL CHxLL Upper limit  
value Lower limit value  
channel x**

For each channel an *upper* and a *lower limit* may be defined. Here only values of the nominal range may be preset, otherwise you receive a parameterization error. By presetting 7FFFh for the upper respectively 8000h for the lower limit value the corresponding limit is deactivated. As soon as the measuring value is beyond the limits and the limit value monitoring is activated, a hardware interrupt is initialized.

**3.4.3 Diagnostics and interrupt**

Event	Hardware interrupt	Diagnostics interrupt	parameterizable
Error in project engineering / parameterization	-	X	-
Measuring range overflow	-	X	-
Measuring range underflow	-	X	-
Limit overflow	X	-	X
Limit underflow	X	-	X
diagnostics buffer overflow	-	X	-
Hardware interrupt lost	-	X	-
Sensor voltage monitoring	-	X	-



**Hardware interrupt**

So you may react to asynchronous events, there is the possibility to activate a hardware interrupt.

- A hardware interrupt interrupts the linear program sequence and jumps depending on the master system to a corresponding Interrupt routine. Here you can react to the hardware interrupt accordingly.
- With CANopen the hardware interrupt data is transferred via an emergency telegram.
- Operating with CPU, PROFIBUS and PROFINET the hardware interrupt data were transferred via diagnostics telegram.

SX Subindex for access via EtherCAT with Index 5000h

More can be found in the according manual of your bus coupler.

Name	Bytes	Function	Default	SX
PRIT_OL	1	Upper limit overflow channel x	00h	02h
PRIT_UL	1	Lower limit underflow channel x	00h	03h
PRIT_US	2	µs-Ticker	00h	04h (high byte) 05h (low byte)

**PRIT\_OL**  
*Upper limit overflow*

Byte	Bit 7 ... 0
0	<ul style="list-style-type: none"> <li>■ Bit 0: Upper limit overflow channel 0</li> <li>■ Bit 1: Upper limit overflow channel 1</li> <li>■ Bit 7 ... 2: reserved</li> </ul>

**PRIT\_UL**  
*Under limit underflow*

Byte	Bit 7 ... 0
0	<ul style="list-style-type: none"> <li>■ Bit 0: Lower limit underflow channel 0</li> <li>■ Bit 1: Lower limit underflow channel 1</li> <li>■ Bit 7 ... 2: reserved</li> </ul>

**PRIT\_US** *µs-Ticker*

Byte	Bit 7 ... 0
0...1	16bit µs value at the moment of the interrupt

*µs ticker*

In the module there is a 32 bit timer (µs ticker). With PowerON the timer starts counting with 0. After  $2^{32}-1\mu\text{s}$  the timer starts with 0 again. PRIT\_US represents the lower 2 byte of the µs ticker value ( $0 \dots 2^{16}-1$ ).

**Diagnostic data**

Via the parametrization you may activate a diagnostic interrupt for the module. With a diagnostics interrupt the module serves for diagnostics data for diagnostic interrupt<sub>incoming</sub>. As soon as the reason for releasing a diagnostic interrupt is no longer present, the diagnostic interrupt<sub>going</sub> automatically takes place. All events of a channel between diagnostic interrupt<sub>incoming</sub> and diagnostic interrupt<sub>going</sub> are not stored and get lost. Within this time window (1. diagnostic interrupt<sub>incoming</sub> until last diagnostic interrupt<sub>going</sub>) the MF-LED of the module is on.

031-1BB10 - AI 2x12Bit 0(4)...20mA - ISO &gt; Diagnostics and interrupt

- DS Record set for access via CPU, PROFIBUS and PROFINET. The access happens by DS 01h. Additionally the first 4 bytes may be accessed by DS 00h.
- IX Index for access via CANopen. The access happens by IX 2F01h. Additionally the first 4 bytes may be accessed by IX 2F00h.
- SX Subindex for access via EtherCAT with Index 5005h.
- More can be found in the according manual of your bus coupler.

Name	Bytes	Function	Default	DS	IX	SX	
ERR_A	1	Diagnostic	00h	01h	2F01h	02h	
MODTYP	1	Module information	15h			03h	
RES2	1	reserved	00h			04h	
ERR_D	1	Diagnostic	00h			05h	
CHTYP	1	Channel type	71h			06h	
NUMBIT	1	Number diagnostic bits per channel	08h			07h	
NUMCH	1	Number of channels of a module	02h			08h	
CHERR	1	Channel error	00h			09h	
CH0ERR	1	Channel-specific error channel 0	00h			0Ah	
CH1ERR	1	Channel-specific error channel 1	00h			0Bh	
CH2ERR... CH7ERR	6	reserved	00h			0Ch ... 11h	
DIAG_US	4	µs ticker	00h				13h

**ERR\_A Diagnostic**

Byte	Bit 7 ... 0
0	<ul style="list-style-type: none"> <li>■ Bit 0: set at module failure</li> <li>■ Bit 1: set at internal error</li> <li>■ Bit 2: set at external error</li> <li>■ Bit 3: set at channel error</li> <li>■ Bit 4: set at external auxiliary supply missing</li> <li>■ Bit 6 ... 5: reserved</li> <li>■ Bit 7: set at error in parametrization</li> </ul>

**MODTYP  
Module information**

Byte	Bit 7 ... 0
0	<ul style="list-style-type: none"> <li>■ Bit 3 ... 0: module class <ul style="list-style-type: none"> <li>- 0101b analog module</li> </ul> </li> <li>■ Bit 4: set at channel information present</li> <li>■ Bit 7 ... 5: reserved</li> </ul>

**ERR\_D Diagnostic**

Byte	Bit 7 ... 0
0	<ul style="list-style-type: none"> <li>■ Bit 2 ... 0: reserved</li> <li>■ Bit 3: set at internal diagnostics buffer overflow</li> <li>■ Bit 4: set at internal communication error</li> <li>■ Bit 5: reserved</li> <li>■ Bit 6: set at hardware interrupt lost</li> <li>■ Bit 7: reserved</li> </ul>

**CHTYP Channel type**

Byte	Bit 7 ... 0
0	<ul style="list-style-type: none"> <li>■ Bit 6 ... 0: Channel type <ul style="list-style-type: none"> <li>- 70h: Digital input</li> <li>- 71h: Analog input</li> <li>- 72h: Digital output</li> <li>- 73h: Analog output</li> <li>- 74h: Analog input/-output</li> <li>- 76h: Counter</li> </ul> </li> <li>■ Bit 7: reserved</li> </ul>

**NUMBIT Diagnostic bits**

Byte	Bit 7 ... 0
0	Number of diagnostic bits per channel (here 08h)

**NUMCH Channels**

Byte	Bit 7 ... 0
0	Number of channels of a module (here 02h)

**CHERR Channel error**

Byte	Bit 7 ... 0
0	<ul style="list-style-type: none"> <li>■ Bit 0: set at error in channel group 0</li> <li>■ Bit 1: set at error in channel group 1</li> <li>■ Bit 7 ... 2: reserved</li> </ul>

**CH0ERR / CH1ERR  
Channel-specific**

Byte	Bit 7 ... 0
0	Channel-specific error: Channel x: <ul style="list-style-type: none"> <li>■ Bit 0: set at project engineering/parameterization error</li> <li>■ Bit 1: raw value above the permissible range</li> <li>■ Bit 2: raw value below the acceptable range</li> <li>■ Bit 3: reserved</li> <li>■ Bit 4: error sensor supply voltage</li> <li>■ Bit 5: set at hardware interrupt lost</li> <li>■ Bit 6: set at measuring range underflow</li> <li>■ Bit 7: set at measuring range overflow</li> </ul>

031-1BB10 - AI 2x12Bit 0(4)...20mA - ISO > Diagnostics and interrupt

**CH2ERR ... CH7ERR**  
*reserved*

Byte	Bit 7 ... 0
0	reserved

**DIAG\_US** *μs ticker*

Byte	Bit 7 ... 0
0...3	Value of the $\mu\text{s}$ ticker at the moment of the diagnostic

*μs ticker*

In the System SLIO module there is a timer ( $\mu\text{s}$  ticker). With PowerON the timer starts counting with 0. After  $2^{32}-1\mu\text{s}$  the timer starts with 0 again.

### 3.5 031-1BB30 - AI 2x12Bit 0...10V

**Properties**

The electronic module has 2 inputs with parameterizable functions. The channels of the module are electrically isolated from the backplane bus. In addition, the channels are isolated to the DC 24V power supply by means of DC/DC converter.

- 2 analog inputs
- Suited for sensors with 0 ... 10V
- Diagnostics function
- 12bit resolution

**Structure**

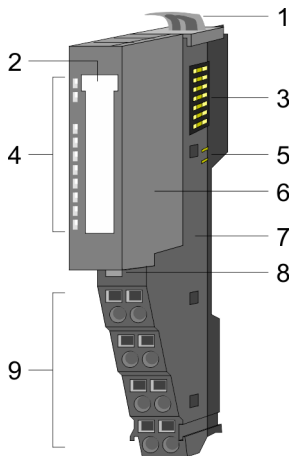

- 1 Locking lever terminal module
- 2 Labeling strip
- 3 Backplane bus
- 4 LED status indication
- 5 DC 24V power section supply
- 6 Electronic module
- 7 Terminal module
- 8 Locking lever electronic module
- 9 Terminal

**Status indication**

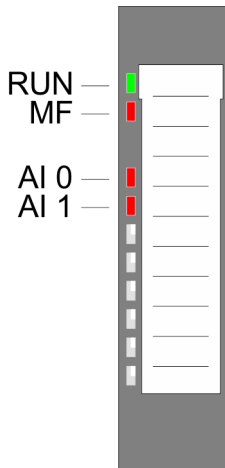

RUN	MF	AI x	Description
<input checked="" type="checkbox"/> green	<input checked="" type="checkbox"/> red	<input checked="" type="checkbox"/> red	
<input checked="" type="checkbox"/>	<input type="checkbox"/>	X	Bus communication is OK Module status is OK
<input checked="" type="checkbox"/>	<input checked="" type="checkbox"/>	X	Bus communication is OK Module status reports an error
<input type="checkbox"/>	<input checked="" type="checkbox"/>	X	Bus communication is not possible Module status reports an error
<input type="checkbox"/>	<input type="checkbox"/>	X	Error at bus power supply
X	<input checked="" type="checkbox"/>	X	Error in configuration → <a href="#">‘Trouble shooting - LEDs’...page 41</a>
<input checked="" type="checkbox"/>	<input type="checkbox"/>	<input checked="" type="checkbox"/>	Error channel x <ul style="list-style-type: none"> <li>■ Signal leaves measuring range</li> <li>■ Error in parameterization</li> </ul>
not relevant: X			

031-1BB30 - AI 2x12Bit 0...10V

**Pin assignment**

For wires with a cross section of 0.08mm<sup>2</sup> up to 1.5mm<sup>2</sup>.

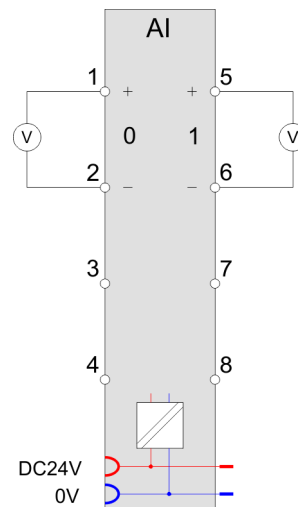
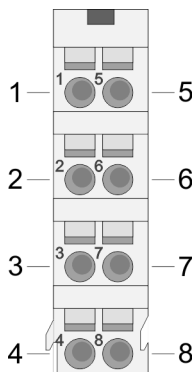

Pos.	Function	Type	Description
1	+AI 0	I	+ Channel 0
2	-AI 0	I	Ground Channel 0
3	---	---	not connected
4	---	---	not connected
5	+AI 1	I	+ Channel 1
6	-AI 1	I	Ground Channel 1
7	---	---	not connected
8	---	---	not connected

I: Input

**In-/Output area**

At CPU, PROFIBUS and PROFINET the input respectively output area is embedded to the corresponding address area.

IX Index for access via CANopen with s = Subindex, depends on number and type of analog modules

SX Subindex for access via EtherCAT with Index 6000h + EtherCAT-Slot

More can be found in the according manual of your bus coupler.

**Input area**

Addr.	Name	Bytes	Function	IX	SX
+0	AI 0	2	Analog value channel 0	6401h/s	01h
+2	AI 1	2	Analog value channel 1	6401h/s+1	02h

**Output area**

No byte of the output area is used by the module.

## 3.5.1 Technical data

Order no.	031-1BB30
Type	SM 031 - Analog input
Module ID	0401 15C3
<b>Current consumption/power loss</b>	
Current consumption from backplane bus	80 mA
Power loss	0.7 W
<b>Technical data analog inputs</b>	
Number of inputs	2
Cable length, shielded	200 m
Rated load voltage	DC 24 V
Current consumption from load voltage L+ (without load)	15 mA
Voltage inputs	✓
Min. input resistance (voltage range)	100 kΩ
Input voltage ranges	0 V ... +10 V
Operational limit of voltage ranges	+/-0.3%
Operational limit of voltage ranges with SFU	-
Basic error limit voltage ranges	+/-0.2%
Basic error limit voltage ranges with SFU	-
Destruction limit voltage	max. 30V
Current inputs	-
Max. input resistance (current range)	-
Input current ranges	-
Operational limit of current ranges	-
Operational limit of current ranges with SFU	-
Basic error limit current ranges	-
Radical error limit current ranges with SFU	-
Destruction limit current inputs (voltage)	-
Destruction limit current inputs (electrical current)	-
Resistance inputs	-
Resistance ranges	-
Operational limit of resistor ranges	-
Operational limit of resistor ranges with SFU	-
Basic error limit	-
Basic error limit with SFU	-
Destruction limit resistance inputs	-
Resistance thermometer inputs	-
Resistance thermometer ranges	-
Operational limit of resistance thermometer ranges	-

031-1BB30 - AI 2x12Bit 0...10V &gt; Technical data

Order no.	031-1BB30
Operational limit of resistance thermometer ranges with SFU	-
Basic error limit thermoresistor ranges	-
Basic error limit thermoresistor ranges with SFU	-
Destruction limit resistance thermometer inputs	-
Thermocouple inputs	-
Thermocouple ranges	-
Operational limit of thermocouple ranges	-
Operational limit of thermocouple ranges with SFU	-
Basic error limit thermocouple ranges	-
Basic error limit thermocouple ranges with SFU	-
Destruction limit thermocouple inputs	-
Programmable temperature compensation	-
External temperature compensation	-
Internal temperature compensation	-
Temperature error internal compensation	-
Technical unit of temperature measurement	-
Resolution in bit	12
Measurement principle	successive approximation
Basic conversion time	2 ms all channels
Noise suppression for frequency	>50dB at 50Hz (UCM<2V)
<b>Status information, alarms, diagnostics</b>	
Status display	yes
Interrupts	no
Process alarm	no
Diagnostic interrupt	no
Diagnostic functions	yes
Diagnostics information read-out	possible
Module state	green LED
Module error display	red LED
Channel error display	red LED per channel
<b>Isolation</b>	
Between channels	-
Between channels of groups to	-
Between channels and backplane bus	✓
Between channels and power supply	✓
Max. potential difference between circuits	-
Max. potential difference between inputs (Ucm)	DC 2 V



Order no.	031-1BB30
Max. potential difference between Mana and Mintern (Uiso)	-
Max. potential difference between inputs and Mana (Ucm)	-
Max. potential difference between inputs and Mintern (Uiso)	DC 75 V/ AC 50 V
Max. potential difference between Mintern and outputs	-
Insulation tested with	DC 500 V
<b>Technical data encoder supply</b>	
Number of outputs	-
Output voltage (typ)	-
Output voltage (rated value)	-
Short-circuit protection	-
Binding of potential	-
<b>Datasizes</b>	
Input bytes	4
Output bytes	0
Parameter bytes	6
Diagnostic bytes	20
<b>Housing</b>	
Material	PPE / PPE GF10
Mounting	Profile rail 35 mm
<b>Mechanical data</b>	
Dimensions (WxHxD)	12.9 mm x 109 mm x 76.5 mm
Net weight	59 g
Weight including accessories	59 g
Gross weight	74 g
<b>Environmental conditions</b>	
Operating temperature	0 °C to 60 °C
Storage temperature	-25 °C to 70 °C
<b>Certifications</b>	
UL certification	yes
KC certification	yes
UKCA certification	yes
ChinaRoHS certification	yes

SFU

Interference frequency suppression

### 3.5.2 Parameter data

- DS Record set for access via CPU, PROFIBUS and PROFINET  
 IX Index for access via CANopen  
 SX Subindex for access via EtherCAT with Index 3100h + EtherCAT-Slot  
 More can be found in the according manual of your bus coupler.

Name	Bytes	Function	Default	DS	IX	SX
CH0FN	1	Function number channel 0	10h	80h	3100h	01h
CH1FN	1	Function number channel 1	10h	81h	3101h	02h

#### CHxFN Function number channel x

In the following there are the measuring ranges with function number listed, which were supported by the analog module. With FFh the corresponding channel is deactivated. The formulas listed here allow you to transform an evaluated measuring value (digital value) to a value assigned to the measuring range (analog value) and vice versa.

Meas. range Voltage 0 ... 10V (funct. no.)	Voltage (U)	Decimal (D)	Hex	Range	Formulas
0 ... 10V Siemens S7 format (10h)	11.76V	32511	7EFFh	overrange	$D = 27648 \cdot \frac{U}{10}$ $U = D \cdot \frac{10}{27648}$
	10V	27648	6C00h	nominal range	
	5V	13824	3600h		
	0V	0	0000h		
	-1.76V	-4864	ED00h	underrange	
0 ... 10V Siemens S5 format (20h)	12.5V	20480	5000h	overrange	$D = 16384 \cdot \frac{U}{10}$ $U = D \cdot \frac{10}{16384}$
	10V	16384	4000h	nominal range	
	5V	8192	2000h		
	0V	0	0000h		
	-2V	-3277	F333h	underrange	

### 3.5.3 Diagnostic data

This module does not support diagnostic interrupt functions, the diagnostics data serve for information about this module. On error the corresponding channel LED of the module is activated and the error is registered in the diagnostics data.

The following errors are listed in the diagnostics data:

- Error in project engineering / parameterization
- Measuring range overflow
- Measuring range underflow

- DS Record set for access via CPU, PROFIBUS and PROFINET. The access happens by DS 01h. Additionally the first 4 bytes may be accessed by DS 00h.
- IX Index for access via CANopen. The access happens by IX 2F01h. Additionally the first 4 bytes may be accessed by IX 2F00h.
- SX Subindex for access via EtherCAT with Index 5005h.
- More can be found in the according manual of your bus coupler.

Name	Bytes	Function	Default	DS	IX	SX
ERR_A	1	Diagnostic	00h	01h	2F01h	02h
MODTYP	1	Module information	15h			03h
ERR_C	1	reserved	00h			04h
ERR_D	1	Diagnostic	00h			05h
CHTYP	1	Channel type	71h			06h
NUMBIT	1	Number diagnostic bits per channel	08h			07h
NUMCH	1	Number of channels of a module	02h			08h
CHERR	1	Channel error	00h			09h
CH0ERR	1	Channel-specific error channel 0	00h			0Ah
CH1ERR	1	Channel-specific error channel 1	00h			0Bh
CH2ERR... CH7ERR	6	reserved	00h			0Ch ... 11h
DIAG_US	4	µs ticker	00h			13h

**ERR\_A Diagnostic**

Byte	Bit 7 ... 0
0	<ul style="list-style-type: none"> <li>■ Bit 0: set at module failure</li> <li>■ Bit 1: set at internal error</li> <li>■ Bit 2: set at external error</li> <li>■ Bit 3: set at channel error</li> <li>■ Bit 4: set at external auxiliary supply missing</li> <li>■ Bit 6 ... 5: reserved</li> <li>■ Bit 7: set at error in parametrization</li> </ul>

**MODTYP  
Module information**

Byte	Bit 7 ... 0
0	<ul style="list-style-type: none"> <li>■ Bit 3 ... 0: module class <ul style="list-style-type: none"> <li>- 0101b analog module</li> </ul> </li> <li>■ Bit 4: set at channel information present</li> <li>■ Bit 7 ... 5: reserved</li> </ul>

031-1BB30 - AI 2x12Bit 0...10V &gt; Diagnostic data

**ERR\_D Diagnostic**

Byte	Bit 7 ... 0
0	<ul style="list-style-type: none"> <li>■ Bit 2 ... 0: reserved</li> <li>■ Bit 3: set at internal diagnostics buffer overflow</li> <li>■ Bit 4: set at internal communication error</li> <li>■ Bit 7 ... 5: reserved</li> </ul>

**CHTYP Channel type**

Byte	Bit 7 ... 0
0	<ul style="list-style-type: none"> <li>■ Bit 6 ... 0: Channel type <ul style="list-style-type: none"> <li>- 70h: Digital input</li> <li>- 71h: Analog input</li> <li>- 72h: Digital output</li> <li>- 73h: Analog output</li> <li>- 74h: Analog input/-output</li> <li>- 76h: Counter</li> </ul> </li> <li>■ Bit 7: reserved</li> </ul>

**NUMBIT Diagnostic bits**

Byte	Bit 7 ... 0
0	Number of diagnostic bits per channel (here 08h)

**NUMCH Channels**

Byte	Bit 7 ... 0
0	Number of channels of a module (here 02h)

**CHERR Channel error**

Byte	Bit 7 ... 0
0	<ul style="list-style-type: none"> <li>■ Bit 0: set at error in channel group 0</li> <li>■ Bit 1: set at error in channel group 1</li> <li>■ Bit 7 ... 2: reserved</li> </ul>

**CH0ERR / CH1ERR  
Channel-specific**

Byte	Bit 7 ... 0
0	Channel-specific error channel x: <ul style="list-style-type: none"> <li>■ Bit 0: set at configuring/parameter assignment error</li> <li>■ Bit 5 ... 1: reserved</li> <li>■ Bit 6: set at measuring range underflow</li> <li>■ Bit 7: set at measuring range overflow</li> </ul>

**CH2ERR ... CH7ERR  
reserved**

Byte	Bit 7 ... 0
0	reserved

**DIAG\_US  $\mu$ s ticker**

Byte	Bit 7 ... 0
0...3	Value of the $\mu$ s ticker at the moment of the diagnostic

 **$\mu$ s ticker**

In the System SLIO module there is a timer ( $\mu$ s ticker). With PowerON the timer starts counting with 0. After  $2^{32}-1\mu$ s the timer starts with 0 again.

031-1BB40 - AI 2x12Bit 0(4)...20mA

### 3.6 031-1BB40 - AI 2x12Bit 0(4)...20mA

#### Properties

The electronic module has 2 inputs with parameterizable functions. The channels of the module are electrically isolated from the backplane bus. In addition, the channels are isolated to the DC 24V power supply by means of DC/DC converter.

- 2 analog inputs
- Suited for sensors with 0 ... 20mA;  
4 ... 20mA with external supply
- Diagnostics function
- 12bit resolution

#### Structure

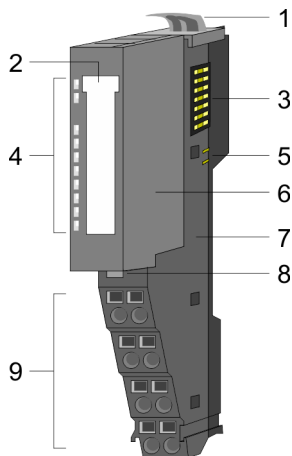

- 1 Locking lever terminal module
- 2 Labeling strip
- 3 Backplane bus
- 4 LED status indication
- 5 DC 24V power section supply
- 6 Electronic module
- 7 Terminal module
- 8 Locking lever electronic module
- 9 Terminal

#### Status indication

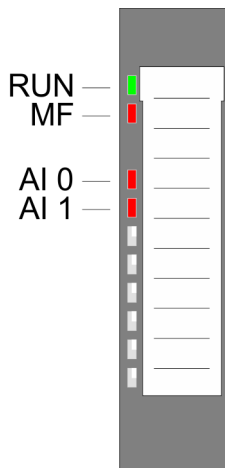

RUN	MF	AI x	Description
<input checked="" type="checkbox"/> green	<input checked="" type="checkbox"/> red	<input checked="" type="checkbox"/> red	
<input checked="" type="checkbox"/>	<input type="checkbox"/>	X	Bus communication is OK Module status is OK
<input checked="" type="checkbox"/>	<input checked="" type="checkbox"/>	X	Bus communication is OK Module status reports an error
<input type="checkbox"/>	<input checked="" type="checkbox"/>	X	Bus communication is not possible Module status reports an error
<input type="checkbox"/>	<input type="checkbox"/>	X	Error at bus power supply
X	<input checked="" type="checkbox"/>	X	Error in configuration → <a href="#">'Trouble shooting - LEDs'...page 41</a>
<input checked="" type="checkbox"/>	<input type="checkbox"/>	<input checked="" type="checkbox"/>	Error channel x <ul style="list-style-type: none"> <li>■ Signal leaves measuring range</li> <li>■ Error in parameterization</li> </ul>
not relevant: X			

**Pin assignment**

For wires with a cross section of 0.08mm<sup>2</sup> up to 1.5mm<sup>2</sup>.

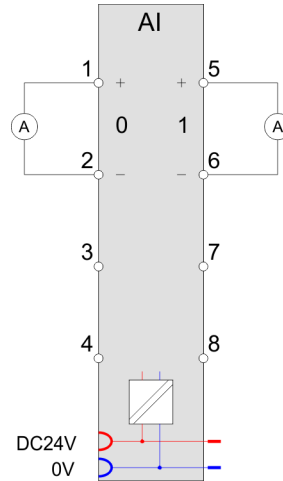
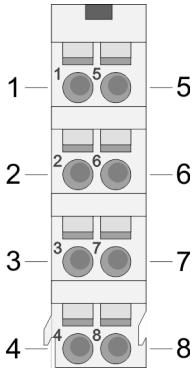

Pos.	Function	Type	Description
1	+AI 0	I	+ Channel 0
2	-AI 0	I	Ground Channel 0
3	---	---	not connected
4	---	---	not connected
5	+AI 1	I	+ Channel 1
6	-AI 1	I	Ground Channel 1
7	---	---	not connected
8	---	---	not connected

I: Input



*If a 2wire measuring transducer is used, you have to connect in line an external power supply.*

**In-/Output area**

At CPU, PROFIBUS and PROFINET the input respectively output area is embedded to the corresponding address area.

IX Index for access via CANopen with s = Subindex, depends on number and type of analog modules

SX Subindex for access via EtherCAT with Index 6000h + EtherCAT-Slot

More can be found in the according manual of your bus coupler.

**Input area**

Addr.	Name	Bytes	Function	IX	SX
+0	AI 0	2	Analog value channel 0	6401h/s	01h
+2	AI 1	2	Analog value channel 1	6401h/s+1	02h

**Output area**

No byte of the output area is used by the module.

## 3.6.1 Technical data

Order no.	031-1BB40
Type	SM 031 - Analog input
Module ID	0402 15C3
<b>Current consumption/power loss</b>	
Current consumption from backplane bus	80 mA
Power loss	0.7 W
<b>Technical data analog inputs</b>	
Number of inputs	2
Cable length, shielded	200 m
Rated load voltage	DC 24 V
Current consumption from load voltage L+ (without load)	15 mA
Voltage inputs	-
Min. input resistance (voltage range)	-
Input voltage ranges	-
Operational limit of voltage ranges	-
Operational limit of voltage ranges with SFU	-
Basic error limit voltage ranges	-
Basic error limit voltage ranges with SFU	-
Destruction limit voltage	-
Current inputs	✓
Max. input resistance (current range)	110 Ω
Input current ranges	0 mA ... +20 mA +4 mA ... +20 mA
Operational limit of current ranges	+/-0.3% ... +/-0.5%
Operational limit of current ranges with SFU	-
Basic error limit current ranges	+/-0.2% ... +/-0.3%
Radical error limit current ranges with SFU	-
Destruction limit current inputs (voltage)	max. 24V
Destruction limit current inputs (electrical current)	max. 40mA
Resistance inputs	-
Resistance ranges	-
Operational limit of resistor ranges	-
Operational limit of resistor ranges with SFU	-
Basic error limit	-
Basic error limit with SFU	-
Destruction limit resistance inputs	-
Resistance thermometer inputs	-
Resistance thermometer ranges	-



Order no.	031-1BB40
Operational limit of resistance thermometer ranges	-
Operational limit of resistance thermometer ranges with SFU	-
Basic error limit thermoresistor ranges	-
Basic error limit thermoresistor ranges with SFU	-
Destruction limit resistance thermometer inputs	-
Thermocouple inputs	-
Thermocouple ranges	-
Operational limit of thermocouple ranges	-
Operational limit of thermocouple ranges with SFU	-
Basic error limit thermocouple ranges	-
Basic error limit thermocouple ranges with SFU	-
Destruction limit thermocouple inputs	-
Programmable temperature compensation	-
External temperature compensation	-
Internal temperature compensation	-
Temperature error internal compensation	-
Technical unit of temperature measurement	-
Resolution in bit	12
Measurement principle	successive approximation
Basic conversion time	2 ms all channels
Noise suppression for frequency	>50dB at 50Hz (UCM<2V)
<b>Status information, alarms, diagnostics</b>	
Status display	yes
Interrupts	no
Process alarm	no
Diagnostic interrupt	no
Diagnostic functions	yes
Diagnostics information read-out	possible
Module state	green LED
Module error display	red LED
Channel error display	red LED per channel
<b>Isolation</b>	
Between channels	-
Between channels of groups to	-
Between channels and backplane bus	✓
Between channels and power supply	✓
Max. potential difference between circuits	-

031-1BB40 - AI 2x12Bit 0(4)...20mA &gt; Technical data

Order no.	031-1BB40
Max. potential difference between inputs (Ucm)	DC 2 V
Max. potential difference between Mana and Mintern (Uiso)	-
Max. potential difference between inputs and Mana (Ucm)	-
Max. potential difference between inputs and Mintern (Uiso)	DC 75 V/ AC 50 V
Max. potential difference between Mintern and outputs	-
Insulation tested with	DC 500 V
<b>Technical data encoder supply</b>	
Number of outputs	-
Output voltage (typ)	-
Output voltage (rated value)	-
Short-circuit protection	-
Binding of potential	-
<b>Datasizes</b>	
Input bytes	4
Output bytes	0
Parameter bytes	6
Diagnostic bytes	20
<b>Housing</b>	
Material	PPE / PPE GF10
Mounting	Profile rail 35 mm
<b>Mechanical data</b>	
Dimensions (WxHxD)	12.9 mm x 109 mm x 76.5 mm
Net weight	59 g
Weight including accessories	59 g
Gross weight	74 g
<b>Environmental conditions</b>	
Operating temperature	0 °C to 60 °C
Storage temperature	-25 °C to 70 °C
<b>Certifications</b>	
UL certification	yes
KC certification	yes
UKCA certification	yes
ChinaRoHS certification	yes

SFU

Interference frequency suppression

## 3.6.2 Parameter data

- DS Record set for access via CPU, PROFIBUS and PROFINET  
 IX Index for access via CANopen  
 SX Subindex for access via EtherCAT with Index 3100h + EtherCAT-Slot  
 More can be found in the according manual of your bus coupler.

Name	Bytes	Function	Default	DS	IX	SX
CH0FN	1	Function number channel 0	31h	80h	3100h	01h
CH1FN	1	Function number channel 1	31h	81h	3101h	02h

## CHxFN Function number channel x

In the following there are the measuring ranges with corresponding function number listed, which were supported by the analog module. With FFh the corresponding channel is deactivated. The formulas listed here allow you to transform an evaluated measuring value (digital value) to a value assigned to the measuring range (analog value) and vice versa.

Meas. range Current 0(4) ... 20mA (funct. no.)	Current (I)	Decimal (D)	Hex	Range	Formulas
0 ... 20mA Siemens S7 format (31h)	23.52mA	32511	7EFFh	overrange	$D = 27648 \cdot \frac{I}{20}$ $I = D \cdot \frac{20}{27648}$
	20mA	27648	6C00h	nominal range	
	10mA	13824	3600h		
	0mA	0	0000h		
	-3.52mA	-4864	ED00h	underrange	
0 ... 20mA Siemens S5 format (41h)	25.00mA	20480	5000h	overrange	$D = 16384 \cdot \frac{I}{20}$ $I = D \cdot \frac{20}{16384}$
	20mA	16384	4000h	nominal range	
	10mA	8192	2000h		
	0mA	0	0000h		
	-4,00mA	-3277	F333h	underrange	
4 ... 20mA Siemens S7 format (30h)	22.81mA	32511	7EFFh	overrange	$D = 27648 \cdot \frac{I-4}{16}$ $I = D \cdot \frac{16}{27648} + 4$
	20mA	27648	6C00h	nominal range	
	12mA	13824	3600h		
	4mA	0	0000h		
	1.19mA	-4864	ED00h	underrange	
4 ... 20mA Siemens S5 format (40h)	24.00mA	20480	5000h	overrange	$D = 16384 \cdot \frac{I-4}{16}$ $I = D \cdot \frac{16}{16384} + 4$
	20mA	16384	4000h	nominal range	
	12mA	8192	2000h		
	4mA	0	0000h		
	0.8mA	-3277	F333h	underrange	

### 3.6.3 Diagnostic data

So this module does not support diagnostic interrupt functions, the diagnostics data serve for information about this module. On error the corresponding channel LED of the module is activated and the error is registered in the diagnostics data.

The following errors are listed in the diagnostics data:

- Error in project engineering / parameterization
- Measuring range overflow
- Measuring range underflow

DS Record set for access via CPU, PROFIBUS and PROFINET. The access happens by DS 01h. Additionally the first 4 bytes may be accessed by DS 00h.

IX Index for access via CANopen. The access happens by IX 2F01h. Additionally the first 4 bytes may be accessed by IX 2F00h.

SX Subindex for access via EtherCAT with Index 5005h.

More can be found in the according manual of your bus coupler.

Name	Bytes	Function	Default	DS	IX	SX
ERR_A	1	Diagnostic	00h	01h	2F01h	02h
MODTYP	1	Module information	15h			03h
ERR_C	1	reserved	00h			04h
ERR_D	1	Diagnostic	00h			05h
CHTYP	1	Channel type	71h			06h
NUMBIT	1	Number diagnostic bits per channel	08h			07h
NUMCH	1	Number of channels of a module	02h			08h
CHERR	1	Channel error	00h			09h
CH0ERR	1	Channel-specific error channel 0	00h			0Ah
CH1ERR	1	Channel-specific error channel 1	00h			0Bh
CH2ERR... CH7ERR	6	reserved	00h			0Ch ... 11h
DIAG_US	4	µs ticker	00h			13h

#### ERR\_A Diagnostic

Byte	Bit 7 ... 0
0	<ul style="list-style-type: none"> <li>■ Bit 0: set at module failure</li> <li>■ Bit 1: set at internal error</li> <li>■ Bit 2: set at external error</li> <li>■ Bit 3: set at channel error</li> <li>■ Bit 4: set at external auxiliary supply missing</li> <li>■ Bit 6 ... 5: reserved</li> <li>■ Bit 7: set at error in parametrization</li> </ul>

**MODTYP**  
*Module information*

Byte	Bit 7 ... 0
0	<ul style="list-style-type: none"> <li>■ Bit 3 ... 0: module class               <ul style="list-style-type: none"> <li>- 0101b analog module</li> </ul> </li> <li>■ Bit 4: set at channel information present</li> <li>■ Bit 7 ... 5: reserved</li> </ul>

**ERR\_D Diagnostic**

Byte	Bit 7 ... 0
0	<ul style="list-style-type: none"> <li>■ Bit 2 ... 0: reserved</li> <li>■ Bit 3: set at internal diagnostics buffer overflow</li> <li>■ Bit 4: set at internal communication error</li> <li>■ Bit 7 ... 5: reserved</li> </ul>

**CHTYP Channel type**

Byte	Bit 7 ... 0
0	<ul style="list-style-type: none"> <li>■ Bit 6 ... 0: Channel type               <ul style="list-style-type: none"> <li>- 70h: Digital input</li> <li>- 71h: Analog input</li> <li>- 72h: Digital output</li> <li>- 73h: Analog output</li> <li>- 74h: Analog input/-output</li> <li>- 76h: Counter</li> </ul> </li> <li>■ Bit 7: reserved</li> </ul>

**NUMBIT Diagnostic bits**

Byte	Bit 7 ... 0
0	Number of diagnostic bits per channel (here 08h)

**NUMCH Channels**

Byte	Bit 7 ... 0
0	Number of channels of a module (here 02h)

**CHERR Channel error**

Byte	Bit 7 ... 0
0	<ul style="list-style-type: none"> <li>■ Bit 0: set at error in channel group 0</li> <li>■ Bit 1: set at error in channel group 1</li> <li>■ Bit 7 ... 2: reserved</li> </ul>

**CH0ERR / CH1ERR**  
*Channel-specific*

Byte	Bit 7 ... 0
0	Channel-specific error channel x: <ul style="list-style-type: none"> <li>■ Bit 0: set at configuring/parameter assignment error</li> <li>■ Bit 5 ... 1: reserved</li> <li>■ Bit 6: set at measuring range underflow</li> <li>■ Bit 7: set at measuring range overflow</li> </ul>

031-1BB40 - AI 2x12Bit 0(4)...20mA > Diagnostic data

**CH2ERR ... CH7ERR**  
*reserved*

Byte	Bit 7 ... 0
0	reserved

**DIAG\_US** *μs ticker*

Byte	Bit 7 ... 0
0...3	Value of the μs ticker at the moment of the diagnostic

*μs ticker*

In the System SLIO module there is a timer (μs ticker). With PowerON the timer starts counting with 0. After  $2^{32}-1\mu\text{s}$  the timer starts with 0 again.

### 3.7 031-1BB60 - AI 2x12Bit 0(4)...20mA - Sensor

**Properties**

The electronic module has 2 inputs with parameterizable functions. The channels of the module are isolated to the backplane bus.

- 2 analog inputs
- Integrated sensor supply
- Suited for sensors with 0(4) ... 20mA with external supply
- Diagnostics function
- 12bit resolution

**Structure**

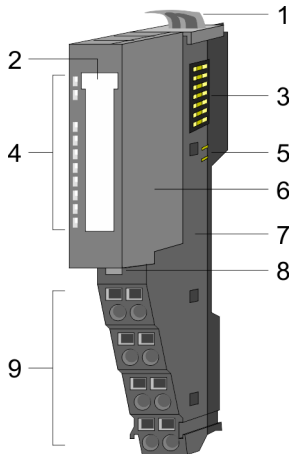

- 1 Locking lever terminal module
- 2 Labeling strip
- 3 Backplane bus
- 4 LED status indication
- 5 DC 24V power section supply
- 6 Electronic module
- 7 Terminal module
- 8 Locking lever electronic module
- 9 Terminal

**Status indication**

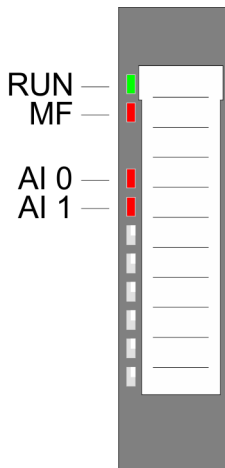

RUN	MF	AI x	Description
<input checked="" type="checkbox"/> green	<input checked="" type="checkbox"/> red	<input checked="" type="checkbox"/> red	
<input checked="" type="checkbox"/>	<input type="checkbox"/>	X	Bus communication is OK Module status is OK
<input checked="" type="checkbox"/>	<input checked="" type="checkbox"/>	X	Bus communication is OK Module status reports an error
<input type="checkbox"/>	<input checked="" type="checkbox"/>	X	Bus communication is not possible Module status reports an error
<input type="checkbox"/>	<input type="checkbox"/>	X	Error at bus power supply
X	<input checked="" type="checkbox"/>	X	Error in configuration → <a href="#">‘Trouble shooting - LEDs’...page 41</a>
<input checked="" type="checkbox"/>	<input type="checkbox"/>	<input checked="" type="checkbox"/>	Error channel x <ul style="list-style-type: none"> <li>■ Signal leaves measuring range</li> <li>■ Error in parameterization</li> </ul>
not relevant: X			



*If the terminal module is not yet wired, when the module is power supplied the AI x LEDs get on due to the default parameterization 4 ... 20mA.*

031-1BB60 - AI 2x12Bit 0(4)...20mA - Sensor

**Pin assignment**

For wires with a cross section of 0.08mm<sup>2</sup> up to 1.5mm<sup>2</sup>.

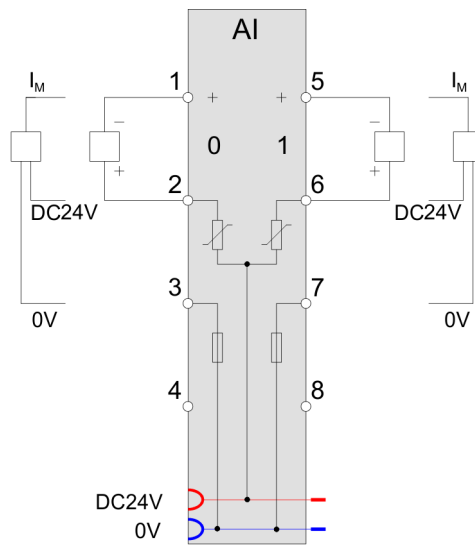
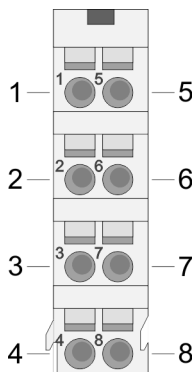

Pos.	Function	Type	Description
1	+AI 0	I	+ Channel 0
2	DC 24V	O	DC 24V for sensor Channel 0
3	0V	O	Ground for sensor (with 3 wire measurement)
4	---	---	not connected
5	+AI 0	I	+ Channel 0
6	DC 24V	O	DC 24V for sensor Channel 1
7	0V	O	Ground for sensor (with 3 wire measurement)
8	---	---	not connected

I: Input, O: Output

**In-/Output area**

At CPU, PROFIBUS and PROFINET the input respectively output area is embedded to the corresponding address area.

IX Index for access via CANopen with s = Subindex, depends on number and type of analog modules

SX Subindex for access via EtherCAT with Index 6000h + EtherCAT-Slot

More can be found in the according manual of your bus coupler.

**Input area**

Addr.	Name	Bytes	Function	IX	SX
+0	AI 0	2	Analog value channel 0	6401h/s	01h
+2	AI 1	2	Analog value channel 1	6401h/s+1	02h

**Output area**

No byte of the output area is used by the module.



## 3.7.1 Technical data

<b>Order no.</b>	<b>031-1BB60</b>
Type	SM 031 - Analog input
Module ID	0407 15C3
<b>Current consumption/power loss</b>	
Current consumption from backplane bus	50 mA
Power loss	0.7 W
<b>Technical data analog inputs</b>	
Number of inputs	2
Cable length, shielded	200 m
Rated load voltage	DC 24 V
Current consumption from load voltage L+ (without load)	15 mA
Voltage inputs	-
Min. input resistance (voltage range)	-
Input voltage ranges	-
Operational limit of voltage ranges	-
Operational limit of voltage ranges with SFU	-
Basic error limit voltage ranges	-
Basic error limit voltage ranges with SFU	-
Destruction limit voltage	-
Current inputs	✓
Max. input resistance (current range)	110 Ω
Input current ranges	0 mA ... +20 mA +4 mA ... +20 mA
Operational limit of current ranges	+/-0.3% ... +/-0.5%
Operational limit of current ranges with SFU	-
Basic error limit current ranges	+/-0.2% ... +/-0.3%
Radical error limit current ranges with SFU	-
Destruction limit current inputs (voltage)	max. 24V
Destruction limit current inputs (electrical current)	max. 40mA
Resistance inputs	-
Resistance ranges	-
Operational limit of resistor ranges	-
Operational limit of resistor ranges with SFU	-
Basic error limit	-
Basic error limit with SFU	-
Destruction limit resistance inputs	-
Resistance thermometer inputs	-
Resistance thermometer ranges	-

031-1BB60 - AI 2x12Bit 0(4)...20mA - Sensor &gt; Technical data

Order no.	031-1BB60
Operational limit of resistance thermometer ranges	-
Operational limit of resistance thermometer ranges with SFU	-
Basic error limit thermoresistor ranges	-
Basic error limit thermoresistor ranges with SFU	-
Destruction limit resistance thermometer inputs	-
Thermocouple inputs	-
Thermocouple ranges	-
Operational limit of thermocouple ranges	-
Operational limit of thermocouple ranges with SFU	-
Basic error limit thermocouple ranges	-
Basic error limit thermocouple ranges with SFU	-
Destruction limit thermocouple inputs	-
Programmable temperature compensation	-
External temperature compensation	-
Internal temperature compensation	-
Temperature error internal compensation	-
Technical unit of temperature measurement	-
Resolution in bit	12
Measurement principle	successive approximation
Basic conversion time	2 ms all channels
Noise suppression for frequency	>50dB at 50Hz (UCM<2V)
<b>Status information, alarms, diagnostics</b>	
Status display	yes
Interrupts	no
Process alarm	no
Diagnostic interrupt	no
Diagnostic functions	yes
Diagnostics information read-out	possible
Module state	green LED
Module error display	red LED
Channel error display	red LED per channel
<b>Isolation</b>	
Between channels	-
Between channels of groups to	-
Between channels and backplane bus	✓
Between channels and power supply	-
Max. potential difference between circuits	-

Order no.	031-1BB60
Max. potential difference between inputs (Ucm)	-
Max. potential difference between Mana and Mintern (Uiso)	-
Max. potential difference between inputs and Mana (Ucm)	-
Max. potential difference between inputs and Mintern (Uiso)	DC 75 V/ AC 50 V
Max. potential difference between Mintern and outputs	-
Insulation tested with	DC 500 V
<b>Technical data encoder supply</b>	
Number of outputs	2
Output voltage (typ)	L+ (-250 mV)
Output voltage (rated value)	50 mA
Short-circuit protection	Multifuse 0.1 A
Binding of potential	Field voltage DC 24V
<b>Datasizes</b>	
Input bytes	4
Output bytes	0
Parameter bytes	6
Diagnostic bytes	20
<b>Housing</b>	
Material	PPE / PPE GF10
Mounting	Profile rail 35 mm
<b>Mechanical data</b>	
Dimensions (WxHxD)	12.9 mm x 109 mm x 76.5 mm
Net weight	58 g
Weight including accessories	58 g
Gross weight	72 g
<b>Environmental conditions</b>	
Operating temperature	0 °C to 60 °C
Storage temperature	-25 °C to 70 °C
<b>Certifications</b>	
UL certification	yes
KC certification	yes
UKCA certification	yes
ChinaRoHS certification	yes

SFU

Interference frequency suppression

### 3.7.2 Parameter data

- DS Record set for access via CPU, PROFIBUS and PROFINET  
 IX Index for access via CANopen  
 SX Subindex for access via EtherCAT with Index 3100h + EtherCAT-Slot  
 More can be found in the according manual of your bus coupler.

Name	Bytes	Function	Default	DS	IX	SX
CH0FN	1	Function number channel 0	30h	80h	3100h	01h
CH1FN	1	Function number channel 1	30h	81h	3101h	02h

#### CHxFN Function number channel x

In the following there are the measuring ranges with corresponding function number listed, which were supported by the analog module. With FFh the corresponding channel is deactivated. The formulas listed here allow you to transform an evaluated measuring value (digital value) to a value assigned to the measuring range (analog value) and vice versa.

Meas. range Current 0(4) ... 20mA (funct. no.)	Current (I)	Decimal (D)	Hex	Range	Formulas
0 ... 20mA Siemens S7 format (31h)	23.52mA	32511	7EFFh	overrange	$D = 27648 \cdot \frac{I}{20}$ $I = D \cdot \frac{20}{27648}$
	20mA	27648	6C00h	nominal range	
	10mA	13824	3600h		
	0mA	0	0000h		
	-3.52mA	-4864	ED00h	underrange	
0 ... 20mA Siemens S5 format (41h)	25.00mA	20480	5000h	overrange	$D = 16384 \cdot \frac{I}{20}$ $I = D \cdot \frac{20}{16384}$
	20mA	16384	4000h	nominal range	
	10mA	8192	2000h		
	0mA	0	0000h		
	-4,00mA	-3277	F333h	underrange	
4 ... 20mA Siemens S7 format (30h)	22.81mA	32511	7EFFh	overrange	$D = 27648 \cdot \frac{I-4}{16}$ $I = D \cdot \frac{16}{27648} + 4$
	20mA	27648	6C00h	nominal range	
	12mA	13824	3600h		
	4mA	0	0000h		
	1.19mA	-4864	ED00h	underrange	
4 ... 20mA Siemens S5 format (40h)	24.00mA	20480	5000h	overrange	$D = 16384 \cdot \frac{I-4}{16}$ $I = D \cdot \frac{16}{16384} + 4$
	20mA	16384	4000h	nominal range	
	12mA	8192	2000h		
	4mA	0	0000h		
	0.8mA	-3277	F333h	underrange	

### 3.7.3 Diagnostic data

So this module does not support diagnostic interrupt functions, the diagnostics data serve for information about this module. On error the corresponding channel LED of the module is activated and the error is registered in the diagnostics data.

The following errors are listed in the diagnostics data:

- Error in project engineering / parameterization
- Measuring range overflow
- Measuring range underflow

**DS** Record set for access via CPU, PROFIBUS and PROFINET. The access happens by DS 01h. Additionally the first 4 bytes may be accessed by DS 00h.

**IX** Index for access via CANopen. The access happens by IX 2F01h. Additionally the first 4 bytes may be accessed by IX 2F00h.

**SX** Subindex for access via EtherCAT with Index 5005h.

More can be found in the according manual of your bus coupler.

Name	Bytes	Function	Default	DS	IX	SX
ERR_A	1	Diagnostic	00h	01h	2F01h	02h
MODTYP	1	Module information	15h			03h
ERR_C	1	reserved	00h			04h
ERR_D	1	Diagnostic	00h			05h
CHTYP	1	Channel type	71h			06h
NUMBIT	1	Number diagnostic bits per channel	08h			07h
NUMCH	1	Number of channels of a module	02h			08h
CHERR	1	Channel error	00h			09h
CH0ERR	1	Channel-specific error channel 0	00h			0Ah
CH1ERR	1	Channel-specific error channel 1	00h			0Bh
CH2ERR... CH7ERR	6	reserved	00h			0Ch ... 11h
DIAG_US	4	µs ticker	00h			13h

#### *ERR\_A Diagnostic*

Byte	Bit 7 ... 0
0	<ul style="list-style-type: none"> <li>■ Bit 0: set at module failure</li> <li>■ Bit 1: set at internal error</li> <li>■ Bit 2: set at external error</li> <li>■ Bit 3: set at channel error</li> <li>■ Bit 4: set at external auxiliary supply missing</li> <li>■ Bit 6 ... 5: reserved</li> <li>■ Bit 7: set at error in parametrization</li> </ul>

031-1BB60 - AI 2x12Bit 0(4)...20mA - Sensor &gt; Diagnostic data

**MODTYP**  
**Module information**

Byte	Bit 7 ... 0
0	<ul style="list-style-type: none"> <li>■ Bit 3 ... 0: module class               <ul style="list-style-type: none"> <li>- 0101b analog module</li> </ul> </li> <li>■ Bit 4: set at channel information present</li> <li>■ Bit 7 ... 5: reserved</li> </ul>

**ERR\_D Diagnostic**

Byte	Bit 7 ... 0
0	<ul style="list-style-type: none"> <li>■ Bit 2 ... 0: reserved</li> <li>■ Bit 3: set at internal diagnostics buffer overflow</li> <li>■ Bit 4: set at internal communication error</li> <li>■ Bit 7 ... 5: reserved</li> </ul>

**CHTYP Channel type**

Byte	Bit 7 ... 0
0	<ul style="list-style-type: none"> <li>■ Bit 6 ... 0: Channel type               <ul style="list-style-type: none"> <li>- 70h: Digital input</li> <li>- 71h: Analog input</li> <li>- 72h: Digital output</li> <li>- 73h: Analog output</li> <li>- 74h: Analog input/-output</li> <li>- 76h: Counter</li> </ul> </li> <li>■ Bit 7: reserved</li> </ul>

**NUMBIT Diagnostic bits**

Byte	Bit 7 ... 0
0	Number of diagnostic bits per channel (here 08h)

**NUMCH Channels**

Byte	Bit 7 ... 0
0	Number of channels of a module (here 02h)

**CHERR Channel error**

Byte	Bit 7 ... 0
0	<ul style="list-style-type: none"> <li>■ Bit 0: set at error in channel group 0</li> <li>■ Bit 1: set at error in channel group 1</li> <li>■ Bit 7 ... 2: reserved</li> </ul>

**CH0ERR / CH1ERR**  
**Channel-specific**

Byte	Bit 7 ... 0
0	Channel-specific error channel x: <ul style="list-style-type: none"> <li>■ Bit 0: set at configuring/parameter assignment error</li> <li>■ Bit 5 ... 1: reserved</li> <li>■ Bit 6: set at measuring range underflow</li> <li>■ Bit 7: set at measuring range overflow</li> </ul>

**CH2ERR ... CH7ERR**  
*reserved*

Byte	Bit 7 ... 0
0	reserved

**DIAG\_US** *μs ticker*

Byte	Bit 7 ... 0
0...3	Value of the μs ticker at the moment of the diagnostic

*μs ticker*

In the System SLIO module there is a timer (μs ticker). With PowerON the timer starts counting with 0. After  $2^{32}-1\mu\text{s}$  the timer starts with 0 again.

### 3.8 031-1BB70 - AI 2x12Bit ±10V

#### Properties

The electronic module has 2 inputs with parameterizable functions. The channels of the module are electrically isolated from the backplane bus. In addition, the channels are isolated to the DC 24V power supply by means of DC/DC converter.

- 2 analog inputs
- Suited for sensors with ±10V, 0 ... 10V
- Diagnostics function
- 12bit resolution

#### Structure

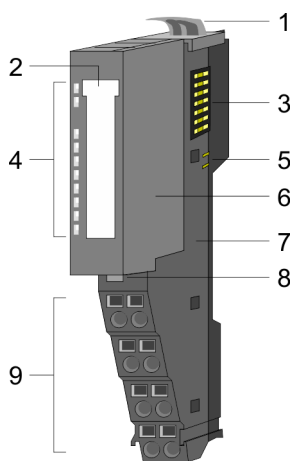

- 1 Locking lever terminal module
- 2 Labeling strip
- 3 Backplane bus
- 4 LED status indication
- 5 DC 24V power section supply
- 6 Electronic module
- 7 Terminal module
- 8 Locking lever electronic module
- 9 Terminal

#### Status indication

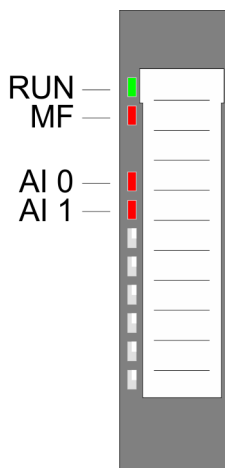

RUN	MF	AI x	Description
<input checked="" type="checkbox"/> green	<input checked="" type="checkbox"/> red	<input checked="" type="checkbox"/> red	
<input checked="" type="checkbox"/>	<input type="checkbox"/>	X	Bus communication is OK Module status is OK
<input checked="" type="checkbox"/>	<input checked="" type="checkbox"/>	X	Bus communication is OK Module status reports an error
<input type="checkbox"/>	<input checked="" type="checkbox"/>	X	Bus communication is not possible Module status reports an error
<input type="checkbox"/>	<input type="checkbox"/>	X	Error at bus power supply
X	<input checked="" type="checkbox"/>	X	Error in configuration → <a href="#">‘Trouble shooting - LEDs’...page 41</a>
<input checked="" type="checkbox"/>	<input type="checkbox"/>	<input checked="" type="checkbox"/>	Error channel x <ul style="list-style-type: none"> <li>■ Signal leaves measuring range</li> <li>■ Error in parameterization</li> </ul>
not relevant: X			



**Pin assignment**

For wires with a cross section of 0.08mm<sup>2</sup> up to 1.5mm<sup>2</sup>.

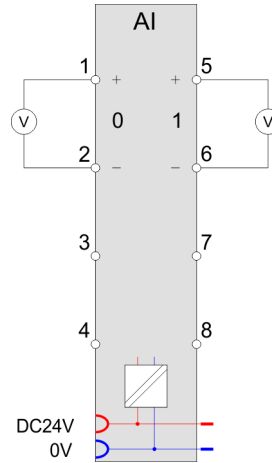
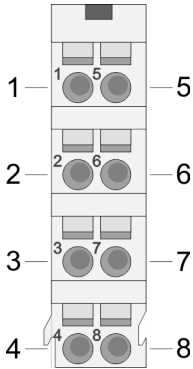

Pos.	Function	Type	Description
1	+AI 0	I	+ Channel 0
2	-AI 0	I	Ground Channel 0
3	---	---	not connected
4	---	---	not connected
5	+AI 1	I	+ Channel 1
6	-AI 1	I	Ground Channel 1
7	---	---	not connected
8	---	---	not connected

I: Input

**In-/Output area**

At CPU, PROFIBUS and PROFINET the input respectively output area is embedded to the corresponding address area.

IX Index for access via CANopen with s = Subindex, depends on number and type of analog modules

SX Subindex for access via EtherCAT with Index 6000h + EtherCAT-Slot

More can be found in the according manual of your bus coupler.

**Input area**

Addr.	Name	Bytes	Function	IX	SX
+0	AI 0	2	Analog value channel 0	6401h/s	01h
+2	AI 1	2	Analog value channel 1	6401h/s+1	02h

**Output area**

No byte of the output area is used by the module.

## 3.8.1 Technical data

Order no.	031-1BB70
Type	SM 031 - Analog input
Module ID	0408 15C3
<b>Current consumption/power loss</b>	
Current consumption from backplane bus	50 mA
Power loss	0.5 W
<b>Technical data analog inputs</b>	
Number of inputs	2
Cable length, shielded	200 m
Rated load voltage	DC 24 V
Current consumption from load voltage L+ (without load)	15 mA
Voltage inputs	✓
Min. input resistance (voltage range)	100 k $\Omega$
Input voltage ranges	-10 V ... +10 V 0 V ... +10 V
Operational limit of voltage ranges	+/-0.3%
Operational limit of voltage ranges with SFU	-
Basic error limit voltage ranges	+/-0.2%
Basic error limit voltage ranges with SFU	-
Destruction limit voltage	max. 30V
Current inputs	-
Max. input resistance (current range)	-
Input current ranges	-
Operational limit of current ranges	-
Operational limit of current ranges with SFU	-
Basic error limit current ranges	-
Radical error limit current ranges with SFU	-
Destruction limit current inputs (voltage)	-
Destruction limit current inputs (electrical current)	-
Resistance inputs	-
Resistance ranges	-
Operational limit of resistor ranges	-
Operational limit of resistor ranges with SFU	-
Basic error limit	-
Basic error limit with SFU	-
Destruction limit resistance inputs	-
Resistance thermometer inputs	-
Resistance thermometer ranges	-

Order no.	031-1BB70
Operational limit of resistance thermometer ranges	-
Operational limit of resistance thermometer ranges with SFU	-
Basic error limit thermoresistor ranges	-
Basic error limit thermoresistor ranges with SFU	-
Destruction limit resistance thermometer inputs	-
Thermocouple inputs	-
Thermocouple ranges	-
Operational limit of thermocouple ranges	-
Operational limit of thermocouple ranges with SFU	-
Basic error limit thermocouple ranges	-
Basic error limit thermocouple ranges with SFU	-
Destruction limit thermocouple inputs	-
Programmable temperature compensation	-
External temperature compensation	-
Internal temperature compensation	-
Temperature error internal compensation	-
Technical unit of temperature measurement	-
Resolution in bit	12
Measurement principle	successive approximation
Basic conversion time	2 ms all channels
Noise suppression for frequency	>50dB at 50Hz (UCM<2V)
<b>Status information, alarms, diagnostics</b>	
Status display	yes
Interrupts	no
Process alarm	no
Diagnostic interrupt	no
Diagnostic functions	yes
Diagnostics information read-out	possible
Module state	green LED
Module error display	red LED
Channel error display	red LED per channel
<b>Isolation</b>	
Between channels	-
Between channels of groups to	-
Between channels and backplane bus	✓
Between channels and power supply	✓
Max. potential difference between circuits	-

031-1BB70 - AI 2x12Bit  $\pm 10V$  > Technical data

Order no.	031-1BB70
Max. potential difference between inputs (Ucm)	DC 2 V
Max. potential difference between Mana and Mintern (Uiso)	-
Max. potential difference between inputs and Mana (Ucm)	-
Max. potential difference between inputs and Mintern (Uiso)	DC 75 V/ AC 50 V
Max. potential difference between Mintern and outputs	-
Insulation tested with	DC 500 V
<b>Technical data encoder supply</b>	
Number of outputs	-
Output voltage (typ)	-
Output voltage (rated value)	-
Short-circuit protection	-
Binding of potential	-
<b>Datasizes</b>	
Input bytes	4
Output bytes	0
Parameter bytes	6
Diagnostic bytes	20
<b>Housing</b>	
Material	PPE / PPE GF10
Mounting	Profile rail 35 mm
<b>Mechanical data</b>	
Dimensions (WxHxD)	12.9 mm x 109 mm x 76.5 mm
Net weight	60 g
Weight including accessories	60 g
Gross weight	74 g
<b>Environmental conditions</b>	
Operating temperature	0 °C to 60 °C
Storage temperature	-25 °C to 70 °C
<b>Certifications</b>	
UL certification	yes
KC certification	yes
UKCA certification	yes
ChinaRoHS certification	yes

SFU

Interference frequency suppression

## 3.8.2 Parameter data

- DS Record set for access via CPU, PROFIBUS and PROFINET  
 IX Index for access via CANopen  
 SX Subindex for access via EtherCAT with Index 3100h + EtherCAT-Slot  
 More can be found in the according manual of your bus coupler.

Name	Bytes	Function	Default	DS	IX	SX
CH0FN	1	Function number channel 0	12h	80h	3100h	01h
CH1FN	1	Function number channel 1	12h	81h	3101h	02h

## CHxFN Function number channel x

In the following there are the measuring ranges with function number listed, which were supported by the analog module. With FFh the corresponding channel is deactivated. The formulas listed here allow you to transform an evaluated measuring value (digital value) to a value assigned to the measuring range (analog value) and vice versa.

Meas. range Voltage ±10V (funct. no.)	Voltage (U)	Decimal (D)	Hex	Range	Formulas
±10V Siemens S7 format (12h)	11.76V	32511	7EFFh	overrange	$D = 27648 \cdot \frac{U}{10}$ $U = D \cdot \frac{10}{27648}$
	10V	27648	6C00h	nominal range	
	5V	13824	3600h		
	0V	0	0000h		
	-5V	-13824	CA00h		
	-10V	-27648	9400h		
	-11.76V	-32512	8100h	underrange	
±10V Siemens S5 format (22h)	12.5V	20480	5000h	overrange	$D = 16384 \cdot \frac{U}{10}$ $U = D \cdot \frac{10}{16384}$
	10V	16384	4000h	nominal range	
	5V	8192	2000h		
	0V	0	0000h		
	-5V	-8192	E000h		
	-10V	-16384	C000h		
	-12.5V	-20480	B000h	underrange	

031-1BB70 - AI 2x12Bit ±10V &gt; Diagnostic data

Meas. range Voltage 0 ... 10V (funct. no.)	Voltage (U)	Decimal (D)	Hex	Range	Formulas
0 ... 10V Siemens S7 format (10h)	11.76V	32511	7EFFh	overrange	$D = 27648 \cdot \frac{U}{10}$ $U = D \cdot \frac{10}{27648}$
	10V	27648	6C00h	nominal range	
	5V	13824	3600h		
	0V	0	0000h		
	-1.76V	-4864	ED00h	underrange	
0 ... 10V Siemens S5 format (20h)	12.5V	20480	5000h	overrange	$D = 16384 \cdot \frac{U}{10}$ $U = D \cdot \frac{10}{16384}$
	10V	16384	4000h	nominal range	
	5V	8192	2000h		
	0V	0	0000h		
	-2V	-3277	F333h	underrange	

### 3.8.3 Diagnostic data

This module does not support diagnostic interrupt functions, the diagnostics data serve for information about this module. On error the corresponding channel LED of the module is activated and the error is registered in the diagnostics data.

The following errors are listed in the diagnostics data:

- Error in project engineering / parameterization
- Measuring range overflow
- Measuring range underflow

DS Record set for access via CPU, PROFIBUS and PROFINET. The access happens by DS 01h. Additionally the first 4 bytes may be accessed by DS 00h.

IX Index for access via CANopen. The access happens by IX 2F01h. Additionally the first 4 bytes may be accessed by IX 2F00h.

SX Subindex for access via EtherCAT with Index 5005h.

More can be found in the according manual of your bus coupler.

Name	Bytes	Function	Default	DS	IX	SX
ERR_A	1	Diagnostic	00h	01h	2F01h	02h
MODTYP	1	Module information	15h			03h
ERR_C	1	reserved	00h			04h
ERR_D	1	Diagnostic	00h			05h
CHTYP	1	Channel type	71h			06h
NUMBIT	1	Number diagnostic bits per channel	08h			07h
NUMCH	1	Number of channels of a module	02h			08h
CHERR	1	Channel error	00h			09h
CH0ERR	1	Channel-specific error channel 0	00h			0Ah
CH1ERR	1	Channel-specific error channel 1	00h			0Bh
CH2ERR... CH7ERR	6	reserved	00h			0Ch ... 11h
DIAG_US	4	$\mu$ s ticker	00h			13h

**ERR\_A Diagnostic**

Byte	Bit 7 ... 0
0	<ul style="list-style-type: none"> <li>■ Bit 0: set at module failure</li> <li>■ Bit 1: set at internal error</li> <li>■ Bit 2: set at external error</li> <li>■ Bit 3: set at channel error</li> <li>■ Bit 4: set at external auxiliary supply missing</li> <li>■ Bit 6 ... 5: reserved</li> <li>■ Bit 7: set at error in parametrization</li> </ul>

**MODTYP  
Module information**

Byte	Bit 7 ... 0
0	<ul style="list-style-type: none"> <li>■ Bit 3 ... 0: module class <ul style="list-style-type: none"> <li>– 0101b analog module</li> </ul> </li> <li>■ Bit 4: set at channel information present</li> <li>■ Bit 7 ... 5: reserved</li> </ul>

**ERR\_D Diagnostic**

Byte	Bit 7 ... 0
0	<ul style="list-style-type: none"> <li>■ Bit 2 ... 0: reserved</li> <li>■ Bit 3: set at internal diagnostics buffer overflow</li> <li>■ Bit 4: set at internal communication error</li> <li>■ Bit 7 ... 5: reserved</li> </ul>

031-1BB70 - AI 2x12Bit  $\pm 10V$  > Diagnostic data**CHTYP Channel type**

Byte	Bit 7 ... 0
0	<ul style="list-style-type: none"> <li>■ Bit 6 ... 0: Channel type               <ul style="list-style-type: none"> <li>- 70h: Digital input</li> <li>- 71h: Analog input</li> <li>- 72h: Digital output</li> <li>- 73h: Analog output</li> <li>- 74h: Analog input/-output</li> <li>- 76h: Counter</li> </ul> </li> <li>■ Bit 7: reserved</li> </ul>

**NUMBIT Diagnostic bits**

Byte	Bit 7 ... 0
0	Number of diagnostic bits per channel (here 08h)

**NUMCH Channels**

Byte	Bit 7 ... 0
0	Number of channels of a module (here 02h)

**CHERR Channel error**

Byte	Bit 7 ... 0
0	<ul style="list-style-type: none"> <li>■ Bit 0: set at error in channel group 0</li> <li>■ Bit 1: set at error in channel group 1</li> <li>■ Bit 7 ... 2: reserved</li> </ul>

**CH0ERR / CH1ERR  
Channel-specific**

Byte	Bit 7 ... 0
0	Channel-specific error channel x: <ul style="list-style-type: none"> <li>■ Bit 0: set at configuring/parameter assignment error</li> <li>■ Bit 5 ... 1: reserved</li> <li>■ Bit 6: set at measuring range underflow</li> <li>■ Bit 7: set at measuring range overflow</li> </ul>

**CH2ERR ... CH7ERR  
reserved**

Byte	Bit 7 ... 0
0	reserved

**DIAG\_US  $\mu$ s ticker**

Byte	Bit 7 ... 0
0...3	Value of the $\mu$ s ticker at the moment of the diagnostic

 *$\mu$ s ticker*

In the System SLIO module there is a timer ( $\mu$ s ticker). With PowerON the timer starts counting with 0. After  $2^{32}-1\mu$ s the timer starts with 0 again.



### 3.9 031-1BB90 - AI 2x16Bit TC

**Properties**

The electronic module has 2 inputs for temperature and voltage measuring with parameterizable functions. The channels of the module are isolated to the backplane bus.

- 2 analog inputs
- Suited for sensors with type J, K, N, R, S, T, B, C, E, L and for voltage measuring ± 80mV
- Interrupt and diagnostics function
- 16bit resolution
- Internal temperature compensation
- High potential gradient of DC75V/AC50V between the inputs

**Structure**

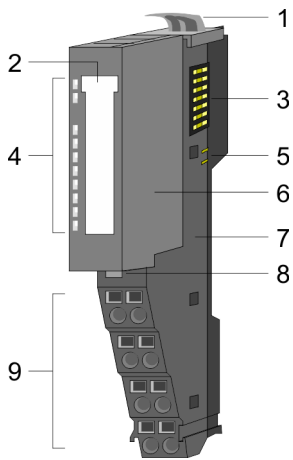

- 1 Locking lever terminal module
- 2 Labeling strip
- 3 Backplane bus
- 4 LED status indication
- 5 DC 24V power section supply
- 6 Electronic module
- 7 Terminal module
- 8 Locking lever electronic module
- 9 Terminal

**Status indication**

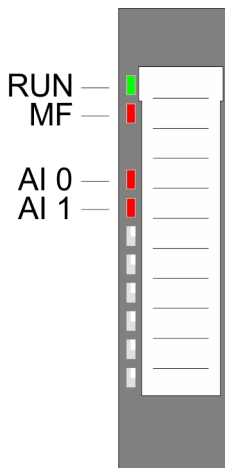

RUN	MF	AI x	Description
<input checked="" type="checkbox"/> green	<input checked="" type="checkbox"/> red	<input checked="" type="checkbox"/> red	
<input checked="" type="checkbox"/>	<input type="checkbox"/>	X	Bus communication is OK Module status is OK
<input checked="" type="checkbox"/>	<input checked="" type="checkbox"/>	X	Bus communication is OK Module status reports an error
<input type="checkbox"/>	<input checked="" type="checkbox"/>	X	Bus communication is not possible Module status reports an error
<input type="checkbox"/>	<input type="checkbox"/>	X	Error at bus power supply
X	<input checked="" type="checkbox"/>	X	Error in configuration → <a href="#">‘Trouble shooting - LEDs’...page 41</a>
<input checked="" type="checkbox"/>	<input type="checkbox"/>	<input checked="" type="checkbox"/>	Error channel x <ul style="list-style-type: none"> <li>■ Signal leaves measuring range</li> <li>■ Error in parameterization</li> <li>■ Wire break (if parameterized)</li> </ul>
not relevant: X			

Pin assignment

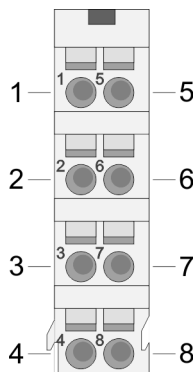

For wires with a cross section of 0.08mm<sup>2</sup> up to 1.5mm<sup>2</sup>.

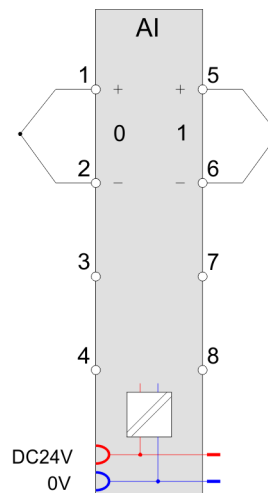

Pos.	Function	Type	Description
1	+TC 0	I	+ Channel 0
2	-TC 0	I	Ground Channel 0
3	---	---	not connected
4	---	---	not connected
5	+TC 1	I	+ Channel 1
6	-TC 1	I	Ground Channel 1
7	---	---	not connected
8	---	---	not connected

I: Input



**CAUTION**

Please consider that the electronic module AI 2x16Bit TC may exclusively be used together with the terminal module 001-0AA20!



*Please take care of the correct polarity when installing the sensors!  
Please install short circuits at non-used inputs by connecting the positive contact with the channel ground of the according channel.*

Supplementation to the installation guidelines

To avoid variations in temperature within the module, which may affect the accuracy of the measurement, you should consider the following points when assembling:

- Do not arrange the module directly apart from a power module with a high feeding current.
- Do not install the module at the end of a line.
- The module should be in a static condition, i.e. the temperature should be as constant as possible in the environment of your module (closed switchgear cabinet free from air draught).
- The accuracy is reached after approx. 30 minutes after entering the static condition.

**In-/Output area**

At CPU, PROFIBUS and PROFINET the input respectively output area is embedded to the corresponding address area.

**IX** Index for access via CANopen with s = Subindex, depends on number and type of analog modules

**SX** Subindex for access via EtherCAT with Index 6000h + EtherCAT-Slot

More can be found in the according manual of your bus coupler.

**Input area**

Addr.	Name	Bytes	Function	IX	SX
+0	AI 0	2	Analog value channel 0	6401h/s	01h
+2	AI 1	2	Analog value channel 1	6401h/s+1	02h

**Output area**

No byte of the output area is used by the module.

**3.9.1 Technical data**

<b>Order no.</b>	<b>031-1BB90</b>
Type	SM 031 - Analog input
Module ID	0403 1543
<b>Current consumption/power loss</b>	
Current consumption from backplane bus	85 mA
Power loss	1.1 W
<b>Technical data analog inputs</b>	
Number of inputs	2
Cable length, shielded	200 m
Rated load voltage	DC 24 V
Current consumption from load voltage L+ (without load)	30 mA
Voltage inputs	-
Min. input resistance (voltage range)	10 MΩ
Input voltage ranges	-80 mV ... +80 mV
Operational limit of voltage ranges	±0.3%
Operational limit of voltage ranges with SFU	±0.1%
Basic error limit voltage ranges	±0.25%
Basic error limit voltage ranges with SFU	±0.05%
Destruction limit voltage	max. 20V
Current inputs	-
Max. input resistance (current range)	-
Input current ranges	-
Operational limit of current ranges	-
Operational limit of current ranges with SFU	-
Basic error limit current ranges	-
Radical error limit current ranges with SFU	-

031-1BB90 - AI 2x16Bit TC &gt; Technical data

Order no.	031-1BB90
Destruction limit current inputs (voltage)	-
Destruction limit current inputs (electrical current)	-
Resistance inputs	-
Resistance ranges	-
Operational limit of resistor ranges	-
Operational limit of resistor ranges with SFU	-
Basic error limit	-
Basic error limit with SFU	-
Destruction limit resistance inputs	-
Resistance thermometer inputs	-
Resistance thermometer ranges	-
Operational limit of resistance thermometer ranges	-
Operational limit of resistance thermometer ranges with SFU	-
Basic error limit thermoresistor ranges	-
Basic error limit thermoresistor ranges with SFU	-
Destruction limit resistance thermometer inputs	-
Thermocouple inputs	✓
Thermocouple ranges	type B type C type E type J type K type L type N type R type S type T
Operational limit of thermocouple ranges	Type E, L, T, J, K, N: $\pm 2.5K$ / Type B, C, R, S: $\pm 8.0K$
Operational limit of thermocouple ranges with SFU	Type E, L, T, J, K, N: $\pm 1.5K$ / Type B, C, R, S: $\pm 4.0K$
Basic error limit thermocouple ranges	Type E, L, T, J, K, N: $\pm 2.0K$ / Type B, C, R, S: $\pm 7.0K$
Basic error limit thermocouple ranges with SFU	Type E, L, T, J, K, N: $\pm 1.0K$ / Type B, C, R, S: $\pm 3.0K$
Destruction limit thermocouple inputs	max. 20V
Programmable temperature compensation	✓
External temperature compensation	✓
Internal temperature compensation	✓
Temperature error internal compensation	1 K
Technical unit of temperature measurement	°C, °F, K
Resolution in bit	16

Order no.	031-1BB90
Measurement principle	Sigma-Delta
Basic conversion time	4.2...324.1 ms (50 Hz) 3.8...270.5 ms (60 Hz) per channel
Noise suppression for frequency	>90dB at 50Hz (UCM<10V)
<b>Status information, alarms, diagnostics</b>	
Status display	yes
Interrupts	yes
Process alarm	yes, parameterizable
Diagnostic interrupt	yes, parameterizable
Diagnostic functions	yes
Diagnostics information read-out	possible
Module state	green LED
Module error display	red LED
Channel error display	red LED per channel
<b>Isolation</b>	
Between channels	-
Between channels of groups to	-
Between channels and backplane bus	✓
Between channels and power supply	-
Max. potential difference between circuits	-
Max. potential difference between inputs (Ucm)	DC 75 V/ AC 50 V
Max. potential difference between Mana and Mintern (Uiso)	-
Max. potential difference between inputs and Mana (Ucm)	-
Max. potential difference between inputs and Mintern (Uiso)	DC 75 V/ AC 50 V
Max. potential difference between Mintern and outputs	-
Insulation tested with	DC 500 V
<b>Technical data encoder supply</b>	
Number of outputs	-
Output voltage (typ)	-
Output voltage (rated value)	-
Short-circuit protection	-
Binding of potential	-
<b>Datasizes</b>	
Input bytes	4
Output bytes	0
Parameter bytes	22
Diagnostic bytes	20

031-1BB90 - AI 2x16Bit TC &gt; Technical data

<b>Order no.</b>	<b>031-1BB90</b>
<b>Housing</b>	
Material	PPE / PPE GF10
Mounting	Profile rail 35 mm
<b>Mechanical data</b>	
Dimensions (WxHxD)	12.9 mm x 109 mm x 76.5 mm
Net weight	58 g
Weight including accessories	58 g
Gross weight	72 g
<b>Environmental conditions</b>	
Operating temperature	0 °C to 60 °C
Storage temperature	-25 °C to 70 °C
<b>Certifications</b>	
UL certification	yes
KC certification	yes
UKCA certification	yes
ChinaRoHS certification	yes

SFU Interference frequency suppression

The indicated error limits are valid starting from the following temperatures:

- Thermoelement type T: -200 °C
- Thermoelement type K: -100 °C
- Thermoelement type B: +700 °C
- Thermoelement type N: -150 °C
- Thermoelement type E: -150 °C
- Thermoelement type R: +200 °C
- Thermoelement type S: +100 °C
- Thermoelement type J: -100 °C

### 3.9.2 Parameter data

DS Record set for access via CPU, PROFIBUS and PROFINET  
 IX Index for access via CANopen  
 SX Subindex for access via EtherCAT with Index 3100h + EtherCAT-Slot  
 More can be found in the according manual of your bus coupler.

Name	Bytes	Function	Default	DS	IX	SX
DIAG_EN	1	Diagnostics <sup>1</sup>	00h	00h	3100h	01h
WIBRK_EN	1	Wire break recognition <sup>1</sup>	00h	00h	3101h	02h
LIMIT_EN	1	Limit value monitoring <sup>1</sup>	00h	00h	3102h	03h
RES3	1	reserved	00h	00h	3103h	04h
TEMPCNF	1	Temperature system	00h	01h	3104h	05h
SUPR	1	Interference frequency suppression (SFU)	02h	01h	3105h	06h
CH0FN	1	Function number channel 0	C1h	80h	3106h	07h
CH0FO	1	Function option channel 0	02h	80h	3107h	08h
CH0UL	2	Upper limit value channel 0	7FFFh	80h	3108h... 3109h	09h
CH0LL	2	Lower limit value channel 0	8000h	80h	310Ah... 310Bh	0Ah
CH1FN	1	Function number channel 1	C1h	81h	310Ch	0Bh
CH1FO	1	Function option channel 1	02h	81h	310Dh	0Ch
CH1UL	2	Upper limit value channel 1	7FFFh	81h	310Eh... 310Fh	0Dh
CH1LL	2	Lower limit value channel 1	8000h	81h	3110h... 3111h	0Eh

1) This record set may only be transferred at STOP state.

#### DIAG\_EN Diagnostic interrupt

Byte	Bit 7 ... 0
0	<ul style="list-style-type: none"> <li>■ Diagnostic interrupt               <ul style="list-style-type: none"> <li>- 00h: disabled</li> <li>- 40h: enabled</li> </ul> </li> </ul>

■ Here you can enable respectively disable the diagnostic interrupt.

031-1BB90 - AI 2x16Bit TC &gt; Parameter data

**WIBRK\_EN**  
Wire break recognition

Byte	Bit 7 ... 0
0	<ul style="list-style-type: none"> <li>■ Bit 0: Wire break recognition channel 0 (1: on)</li> <li>■ Bit 1: Wire break recognition channel 1 (1: on)</li> <li>■ Bit 7 ... 2: reserved</li> </ul>



*Due to the high sensitivity of the inputs, unused inputs should be deactivated in the parametrization. Due to the high input impedance, open inputs can be influenced by adjacent channels or due to the measuring method during wire break detection. Since the entire measuring range moves in the mV range, open-loop inputs can already cause measuring range overshoots.*

**LIMIT\_EN**  
Limit value monitoring

Byte	Bit 7 ... 0
0	<ul style="list-style-type: none"> <li>■ Bit 0: Limit value monitoring channel 0 (1: on)</li> <li>■ Bit 1: Limit value monitoring channel 1 (1: on)</li> <li>■ Bit 7 ... 2: reserved</li> </ul>

**TEMPCNF**  
Temperature system

Byte	Bit 7 ... 0
0	<ul style="list-style-type: none"> <li>■ Bit 0, 1: Temperature system <ul style="list-style-type: none"> <li>- 00: °C</li> <li>- 01: °F</li> <li>- 10: K</li> </ul> </li> <li>■ Bit 7 ... 2: reserved</li> </ul>

**SUPR Interference  
frequency suppression  
(SFU)**

Byte	Bit 7 ... 0
0	<ul style="list-style-type: none"> <li>■ Bit 0, 1: Interference frequency suppression <ul style="list-style-type: none"> <li>- 01: 60Hz</li> <li>- 10: 50Hz</li> </ul> </li> <li>■ Bit 7 ... 2: reserved</li> </ul>

**CHxFN Function number  
channel x**

In the following there are the measuring ranges with corresponding function number listed, which were supported by the analog module.

With FFh the corresponding channel is deactivated.



Meas. range Voltage -80 ... 80mV (funct. no.)	Voltage (U)	Decimal (D)	Hex	Range	Formulas
-80 ... 80mV Siemens S7 format (11h)	94.07mV	32511	7EFFh	overrange	$D = 27648 \cdot \frac{U}{80}$ $U = D \cdot \frac{80}{27648}$
	80mV	27648	6C00h	nominal range	
	0V	0	0000h		
	-80mV	-27648	9400h		
	-94.07mV	-32512	8100h	underrange	
-80 ... 80mV Siemens S5 format (21h)	100mV	20480	5000h	overrange	$D = 16384 \cdot \frac{U}{80}$ $U = D \cdot \frac{80}{16384}$
	80mV	16384	4000h	nominal range	
	0V	0	0000h		
	-80mV	-16384	C000h		
	-100mV	-20480	B000h	underrange	

Measuring range Temperature (funct. no.)	Measuring value in °C (0.1°C/digit)	Measuring value in °F (0.1°F/digit)	Measuring value in K (0.1K/digit)	Range
Type J:	+14500	26420	17232	overrange
[Fe-Cu-Ni IEC]	-2100 ... +12000	-3460 ... 21920	632 ... 14732	nominal range
-210 ... +1200°C -346 ... 2192°F 63.2 ... 1473.2K (B0h: ext. comp. 0°C) (C0h: int. comp. 0°C)	---	---	---	underrange
Type K:	+16220	29516	18952	overrange
[Ni-Cr-Ni]	-2700 ... +13720	-4540 ... 25016	0 ... 16452	nominal range
-270 ... +1372°C -454 ... 2501.6°F 0 ... 1645.2K (B1h: ext. comp. 0°C) (C1h: int. comp. 0°C)	---	---	---	underrange
Type N:	+15500	28220	18232	overrange
[Ni-Cr-Si]	-2700 ... +13000	-4540 ... 23720	0 ... 15732	nominal range
-270 ... +1300°C -454 ... 2372°F 0 ... 1573.2K (B2h: ext. comp. 0°C) (C2h: int. comp. 0°C)	---	---	---	underrange
Type R:	+20190	32766	22922	overrange
[PtRh-Pt]	-500 ... +17690	-580 ... 32162	2232 ... 20422	nominal range

031-1BB90 - AI 2x16Bit TC &gt; Parameter data

Measuring range Temperature (funct. no.)	Measuring value in °C (0.1°C/digit)	Measuring value in °F (0.1°F/digit)	Measuring value in K (0.1K/digit)	Range
-50 ... +1769°C -58 ... 3216.2°F 223.2 ... 2042.2K (B3h: ext. comp. 0°C) (C3h: int. comp. 0°C)	-1700	-2740	1032	underrange
Type S: [PtRh-Pt]	+20190	32766	22922	overrange
-50 ... +1769°C -58 ... 3216.2°F 223.2 ... 2042.2K (B4h: ext. comp. 0°C) (C4h: int. comp. 0°C)	-500 ... +17690	-580 ... 32162	2232 ... 20422	nominal range
	-1700	-2740	1032	underrange
Type T: [Cu-Cu-Ni]	+5400	10040	8132	overrange
-270 ... +400°C -454 ... 752°F 3.2 ... 673.2K (B5h: ext. comp. 0°C) (C5h: int. comp. 0°C)	-2700 ... +4000	-4540 ... 7520	32 ... 6732	nominal range
	---	---	---	underrange
Type B: [PtRh-PtRh]	+20700	32766	23432	overrange
0 ... +1820°C 32 ... 2786.5°F 273.2 ... 2093.2K (B6h: ext. comp. 0°C) (C6h: int. comp. 0°C)	0 ... +18200	320 ... 27865	2732 ... 20932	nominal range
	-1200	-1840	1532	underrange
Type C: [WRe5-WRe26]	+25000	32766	23432	overrange
0 ... +2315°C 32 ... 2786.5°F 273.2 ... 2093.2K (B7h: ext. comp. 0°C) (C7h: int. comp. 0°C)	0 ... +23150	320 ... 27865	2732 ... 20932	nominal range
	-1200	-1840	1532	underrange
Type E: [Ni-Cr - Cu-Ni ]	+12000	21920	14732	overrange
-270 ... +1000°C -454 ... 1832°F 0 ... 1273.2K	-2700 ... +10000	-4540 ... 18320	0 ... 12732	nominal range
	---	---	---	underrange

Measuring range Temperature (funct. no.)	Measuring value in °C (0.1°C/digit)	Measuring value in °F (0.1°F/digit)	Measuring value in K (0.1K/digit)	Range
(B8h: ext. comp. 0°C) (C8h: int. comp. 0°C)				
Type L: [Fe-Cu-Ni] -200 ... +900°C -328 ... 1652°F 73.2 ... 1173.2K (B9h: ext. comp. 0°C) (C9h: int. comp. 0°C)	+11500	21020	14232	overrange
	-2000 ... +9000	-3280 ... 16520	732 ... 11732	nominal range
	---	---	---	underrange

### CHxFO Function option channel x

Depending on the Interference frequency suppression for each channel the transducer velocity may be set.

Code	Velocity (in ms) / channel at interference frequency suppression	
	50Hz	60Hz
00h <sup>1</sup>	324.1	270.5
01h <sup>1</sup>	164.2	137.2
02h <sup>1</sup>	84.2	70.5
03h	44.1	37.2
04h	24.2	20.5
05h	14.2	12.2
06h	9.2	8.0
07h	6.6	5.9
08h	4.2	3.8

1) For Code 00h, 01h and 02h the tolerances of the technical data "with interference frequency suppression" are valid.

### CHxUL / CHxLL limit value

You can specify an upper or lower limit value for each channel x:

- With CHxUL you specify an upper limit value. This is deactivated by specifying 7FFFh.
- With CHxLL you specify a lower limit value. This is deactivated by specifying 8000h.
- You may only specify values from the nominal range, otherwise you will get a parameterization error.
- As soon as your measured value is outside a limit value and you have activated limit value monitoring, a hardware interrupt is triggered.

### 3.9.3 Diagnostics and interrupt

Event	Hardware interrupt	Diagnostics interrupt	parameterizable
Error in project engineering/ parametrization	-	X	-
Wire break	-	X	X
Measuring range overflow	-	X	-
Measuring range underflow	-	X	-
Limit overflow	X	-	X
Limit underflow	X	-	X
Diagnostic buffer overflow	-	X	-
Communication error	-	X	-
Hardware interrupt lost	-	X	-

#### Hardware interrupt

So you may react to asynchronous events, there is the possibility to activate a hardware interrupt.

- A hardware interrupt interrupts the linear program sequence and jumps depending on the master system to a corresponding Interrupt routine. Here you can react to the hardware interrupt accordingly.
- With CANopen the hardware interrupt data is transferred via an emergency telegram.
- Operating with CPU, PROFIBUS and PROFINET the hardware interrupt data were transferred via diagnostics telegram.

SX Subindex for access via EtherCAT with Index 5000h

More can be found in the according manual of your bus coupler.

Name	Bytes	Function	Default	SX
PRIT_OL	1	Upper limit overflow channel x	00h	02h
PRIT_UL	1	Lower limit underflow channel x	00h	03h
PRIT_US	2	µs-Ticker	00h	04h (high byte) 05h (low byte)

#### PRIT\_OL Limit overflow

Byte	Bit 7 ... 0
0	<ul style="list-style-type: none"> <li>■ Bit 0: Limit overflow channel 0</li> <li>■ Bit 1: Limit overflow channel 1</li> <li>■ Bit 7 ... 2: reserved</li> </ul>

#### PRIT\_UL Limit underflow

Byte	Bit 7 ... 0
0	<ul style="list-style-type: none"> <li>■ Bit 0: Limit underflow channel 0</li> <li>■ Bit 1: Limit underflow channel 1</li> <li>■ Bit 7 ... 2: reserved</li> </ul>

**PRIT\_US  $\mu$ s ticker**

Byte	Bit 7 ... 0
0 ... 1	16bit $\mu$ s value at the moment of the interrupt

 **$\mu$ s ticker**

In the module there is a 32 bit timer ( $\mu$ s ticker). With PowerON the timer starts counting with 0. After  $2^{32}-1\mu$ s the timer starts with 0 again. PRIT\_US represents the lower 2 byte of the  $\mu$ s ticker value (0 ...  $2^{16}-1$ ).

**Diagnostic data**

Via the parametrization you may activate a diagnostic interrupt for the module. With a diagnostics interrupt the module serves for diagnostics data for diagnostic interrupt<sub>incoming</sub>. As soon as the reason for releasing a diagnostic interrupt is no longer present, the diagnostic interrupt<sub>going</sub> automatically takes place. All events of a channel between diagnostic interrupt<sub>incoming</sub> and diagnostic interrupt<sub>going</sub> are not stored and get lost. Within this time window (1. diagnostic interrupt<sub>incoming</sub> until last diagnostic interrupt<sub>going</sub>) the MF-LED of the module is on.

DS Record set for access via CPU, PROFIBUS and PROFINET. The access happens by DS 01h. Additionally the first 4 bytes may be accessed by DS 00h.

IX Index for access via CANopen. The access happens by IX 2F01h. Additionally the first 4 bytes may be accessed by IX 2F00h.

SX Subindex for access via EtherCAT with Index 5005h.

More can be found in the according manual of your bus coupler.

Name	Bytes	Function	Default	DS	IX	SX
ERR_A	1	Diagnostic	00h	01h	2F01h	02h
MODTYP	1	Module information	15h			03h
ERR_C	1	reserved	00h			04h
ERR_D	1	Diagnostic	00h			05h
CHTYP	1	Channel type	71h			06h
NUMBIT	1	Number diagnostic bits per channel	08h			07h
NUMCH	1	Number of channels of a module	02h			08h
CHERR	1	Channel error	00h			09h
CH0ERR	1	Channel-specific error channel 0	00h			0Ah
CH1ERR	1	Channel-specific error channel 1	00h			0Bh
CH2ERR ... CH7ERR	6	reserved	00h			0Ch ... 11h
DIAG_US	4	$\mu$ s ticker	00h			13h

**ERR\_A Diagnostic**

Byte	Bit 7 ... 0
0	<ul style="list-style-type: none"> <li>■ Bit 0: set at module failure</li> <li>■ Bit 1: set at internal error</li> <li>■ Bit 2: set at external error</li> <li>■ Bit 3: set at channel error</li> <li>■ Bit 4: set at external auxiliary supply missing</li> <li>■ Bit 6 ... 5: reserved</li> <li>■ Bit 7: set at error in parametrization</li> </ul>

**MODTYP**  
**Module information**

Byte	Bit 7 ... 0
0	<ul style="list-style-type: none"> <li>■ Bit 3 ... 0: module class <ul style="list-style-type: none"> <li>- 0101b analog module</li> </ul> </li> <li>■ Bit 4: set at channel information present</li> <li>■ Bit 7 ... 5: reserved</li> </ul>

**ERR\_D Diagnostic**

Byte	Bit 7 ... 0
0	<ul style="list-style-type: none"> <li>■ Bit 2 ... 0: reserved</li> <li>■ Bit 3: set at internal diagnostics buffer overflow</li> <li>■ Bit 4: set at internal communication error</li> <li>■ Bit 5: reserved</li> <li>■ Bit 6: set at hardware interrupt lost</li> <li>■ Bit 7: reserved</li> </ul>

**CHTYP Channel type**

Byte	Bit 7 ... 0
0	<ul style="list-style-type: none"> <li>■ Bit 6 ... 0: Channel type <ul style="list-style-type: none"> <li>- 70h: Digital input</li> <li>- 71h: Analog input</li> <li>- 72h: Digital output</li> <li>- 73h: Analog output</li> <li>- 74h: Analog input/-output</li> <li>- 76h: Counter</li> </ul> </li> <li>■ Bit 7: reserved</li> </ul>

**NUMBIT Diagnostic bits**

Byte	Bit 7 ... 0
0	Number of diagnostic bits per channel (here 08h)

**NUMCH Channels**

Byte	Bit 7 ... 0
0	Number of channels of a module (here 02h)

**CHERR Channel error**

Byte	Bit 7 ... 0
0	<ul style="list-style-type: none"> <li>■ Bit 0: set at error in channel group 0</li> <li>■ Bit 1: set at error in channel group 1</li> <li>■ Bit 7 ... 2: reserved</li> </ul>

**CH0ERR / CH1ERR  
Channel-specific**

Byte	Bit 7 ... 0
0	Channel-specific error: Channel x: <ul style="list-style-type: none"> <li>■ Bit 0: set at project engineering/parameterization error</li> <li>■ Bit 3 ... 1: reserved</li> <li>■ Bit 4: set at wire break</li> <li>■ Bit 5: set at hardware interrupt lost</li> <li>■ Bit 6: set at measuring range underflow</li> <li>■ Bit 7: set at measuring range overflow</li> </ul>

**CH2ERR ... CH7ERR  
reserved**

Byte	Bit 7 ... 0
0	reserved

**DIAG\_US  $\mu$ s ticker**

Byte	Bit 7 ... 0
0...3	Value of the $\mu$ s ticker at the moment of the diagnostic

 *$\mu$ s ticker*

In the System SLIO module there is a timer ( $\mu$ s ticker). With PowerON the timer starts counting with 0. After  $2^{32}-1\mu$ s the timer starts with 0 again.

### 3.10 031-1BD30 - AI 4x12Bit 0...10V

#### Properties

The electronic module has 4 inputs with parameterizable functions. The channels of the module are electrically isolated from the backplane bus. In addition, the channels are isolated to the DC 24V power supply by means of DC/DC converter.

- 4 analog inputs
- Suited for sensors with 0 ... 10V
- Diagnostics function
- 12bit resolution

#### Structure

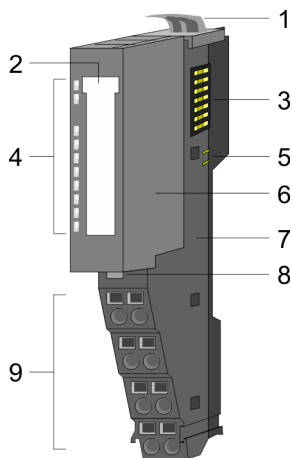

- 1 Locking lever terminal module
- 2 Labeling strip
- 3 Backplane bus
- 4 LED status indication
- 5 DC 24V power section supply
- 6 Electronic module
- 7 Terminal module
- 8 Locking lever electronic module
- 9 Terminal

#### Status indication

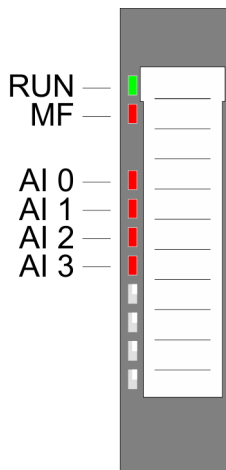

RUN	MF	AI x	Description
<input checked="" type="checkbox"/> green	<input checked="" type="checkbox"/> red	<input checked="" type="checkbox"/> red	
<input checked="" type="checkbox"/>	<input type="checkbox"/>	X	Bus communication is OK Module status is OK
<input checked="" type="checkbox"/>	<input checked="" type="checkbox"/>	X	Bus communication is OK Module status reports an error
<input type="checkbox"/>	<input checked="" type="checkbox"/>	X	Bus communication is not possible Module status reports an error
<input type="checkbox"/>	<input type="checkbox"/>	X	Error at bus power supply
X	<input checked="" type="checkbox"/>	X	Error in configuration → <a href="#">‘Trouble shooting - LEDs’...page 41</a>
<input checked="" type="checkbox"/>	<input type="checkbox"/>	<input checked="" type="checkbox"/>	Error channel x <ul style="list-style-type: none"> <li>■ Signal leaves measuring range</li> <li>■ Error in parameterization</li> </ul>
not relevant: X			



**Pin assignment**

For wires with a cross section of 0.08mm<sup>2</sup> up to 1.5mm<sup>2</sup>.

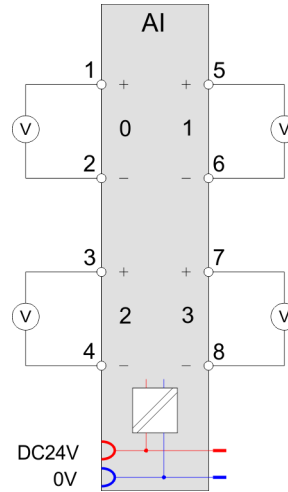
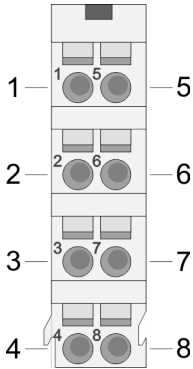

Pos.	Function	Type	Description
1	+AI 0	I	+ Channel 0
2	-AI 0	I	Ground Channel 0
3	+AI 2	I	+ Channel 2
4	-AI 2	I	Ground Channel 2
5	+AI 1	I	+ Channel 1
6	-AI 1	I	Ground Channel 1
7	+AI 3	I	+ Channel 3
8	-AI 3	I	Ground Channel 3

I: Input

**In-/Output area**

At CPU, PROFIBUS and PROFINET the input respectively output area is embedded to the corresponding address area.

IX Index for access via CANopen with s = Subindex, depends on number and type of analog modules

SX Subindex for access via EtherCAT with Index 6000h + EtherCAT-Slot

More can be found in the according manual of your bus coupler.

**Input area**

Addr.	Name	Bytes	Function	IX	SX
+0	AI 0	2	Analog value channel 0	6401h/s	01h
+2	AI 1	2	Analog value channel 1	6401h/s+1	02h
+4	AI 2	2	Analog value channel 2	6401h/s+2	03h
+6	AI 3	2	Analog value channel 3	6401h/s+3	04h

**Output area**

No byte of the output area is used by the module.

## 3.10.1 Technical data

Order no.	031-1BD30
Type	SM 031 - Analog input
Module ID	0404 15C4
<b>Current consumption/power loss</b>	
Current consumption from backplane bus	75 mA
Power loss	0.7 W
<b>Technical data analog inputs</b>	
Number of inputs	4
Cable length, shielded	200 m
Rated load voltage	DC 24 V
Current consumption from load voltage L+ (without load)	15 mA
Voltage inputs	✓
Min. input resistance (voltage range)	100 kΩ
Input voltage ranges	0 V ... +10 V
Operational limit of voltage ranges	+/-0.3%
Operational limit of voltage ranges with SFU	-
Basic error limit voltage ranges	+/-0.2%
Basic error limit voltage ranges with SFU	-
Destruction limit voltage	max. 30V
Current inputs	-
Max. input resistance (current range)	-
Input current ranges	-
Operational limit of current ranges	-
Operational limit of current ranges with SFU	-
Basic error limit current ranges	-
Radical error limit current ranges with SFU	-
Destruction limit current inputs (voltage)	-
Destruction limit current inputs (electrical current)	-
Resistance inputs	-
Resistance ranges	-
Operational limit of resistor ranges	-
Operational limit of resistor ranges with SFU	-
Basic error limit	-
Basic error limit with SFU	-
Destruction limit resistance inputs	-
Resistance thermometer inputs	-
Resistance thermometer ranges	-
Operational limit of resistance thermometer ranges	-

Order no.	031-1BD30
Operational limit of resistance thermometer ranges with SFU	-
Basic error limit thermoresistor ranges	-
Basic error limit thermoresistor ranges with SFU	-
Destruction limit resistance thermometer inputs	-
Thermocouple inputs	-
Thermocouple ranges	-
Operational limit of thermocouple ranges	-
Operational limit of thermocouple ranges with SFU	-
Basic error limit thermocouple ranges	-
Basic error limit thermocouple ranges with SFU	-
Destruction limit thermocouple inputs	-
Programmable temperature compensation	-
External temperature compensation	-
Internal temperature compensation	-
Temperature error internal compensation	-
Technical unit of temperature measurement	-
Resolution in bit	12
Measurement principle	successive approximation
Basic conversion time	4 ms all channels
Noise suppression for frequency	>50dB at 50Hz (UCM<2V)
<b>Status information, alarms, diagnostics</b>	
Status display	yes
Interrupts	no
Process alarm	no
Diagnostic interrupt	no
Diagnostic functions	yes
Diagnostics information read-out	possible
Module state	green LED
Module error display	red LED
Channel error display	red LED per channel
<b>Isolation</b>	
Between channels	-
Between channels of groups to	-
Between channels and backplane bus	✓
Between channels and power supply	✓
Max. potential difference between circuits	-
Max. potential difference between inputs (Ucm)	DC 2 V

031-1BD30 - AI 4x12Bit 0...10V &gt; Technical data

Order no.	031-1BD30
Max. potential difference between Mana and Mintern (Uiso)	-
Max. potential difference between inputs and Mana (Ucm)	-
Max. potential difference between inputs and Mintern (Uiso)	DC 75 V/ AC 50 V
Max. potential difference between Mintern and outputs	-
Insulation tested with	DC 500 V
<b>Technical data encoder supply</b>	
Number of outputs	-
Output voltage (typ)	-
Output voltage (rated value)	-
Short-circuit protection	-
Binding of potential	-
<b>Datasizes</b>	
Input bytes	8
Output bytes	0
Parameter bytes	8
Diagnostic bytes	20
<b>Housing</b>	
Material	PPE / PPE GF10
Mounting	Profile rail 35 mm
<b>Mechanical data</b>	
Dimensions (WxHxD)	12.9 mm x 109 mm x 76.5 mm
Net weight	59 g
Weight including accessories	59 g
Gross weight	74 g
<b>Environmental conditions</b>	
Operating temperature	0 °C to 60 °C
Storage temperature	-25 °C to 70 °C
<b>Certifications</b>	
UL certification	yes
KC certification	yes
UKCA certification	yes
ChinaRoHS certification	yes

SFU

Interference frequency suppression

### 3.10.2 Parameter data

- DS Record set for access via CPU, PROFIBUS and PROFINET  
 IX Index for access via CANopen  
 SX Subindex for access via EtherCAT with Index 3100h + EtherCAT-Slot  
 More can be found in the according manual of your bus coupler.

Name	Bytes	Function	Default	DS	IX	SX
CH0FN	1	Function number channel 0	10h	80h	3100h	01h
CH1FN	1	Function number channel 1	10h	81h	3101h	02h
CH2FN	1	Function number channel 2	10h	82h	3102h	03h
CH3FN	1	Function number channel 3	10h	83h	3103h	04h

#### CHxFN Function number channel x

In the following there are the measuring ranges with corresponding function number listed, which were supported by the analog module. With FFh the corresponding channel is deactivated. The formulas listed here allow you to transform an evaluated measuring value (digital value) to a value assigned to the measuring range (analog value) and vice versa.

Meas. range Voltage 0 ... 10V (funct. no.)	Voltage (U)	Decimal (D)	Hex	Range	Formulas
0 ... 10V Siemens S7 format (10h)	11.76V	32511	7EFFh	overrange	$D = 27648 \cdot \frac{U}{10}$ $U = D \cdot \frac{10}{27648}$
	10V	27648	6C00h	nominal range	
	5V	13824	3600h		
	0V	0	0000h		
	-1.76V	-4864	ED00h	underrange	
0 ... 10V Siemens S5 format (20h)	12.5V	20480	5000h	overrange	$D = 16384 \cdot \frac{U}{10}$ $U = D \cdot \frac{10}{16384}$
	10V	16384	4000h	nominal range	
	5V	8192	2000h		
	0V	0	0000h		
	-2V	-3277	F333h	underrange	

### 3.10.3 Diagnostic data

So this module does not support diagnostic interrupt functions, the diagnostics data serve for information about this module. On error the corresponding channel LED of the module is activated and the error is registered in the diagnostics data.

The following errors are listed in the diagnostics data:

- Error in project engineering / parameterization
- Measuring range overflow
- Measuring range underflow

031-1BD30 - AI 4x12Bit 0...10V &gt; Diagnostic data

- DS Record set for access via CPU, PROFIBUS and PROFINET. The access happens by DS 01h. Additionally the first 4 bytes may be accessed by DS 00h.
- IX Index for access via CANopen. The access happens by IX 2F01h. Additionally the first 4 bytes may be accessed by IX 2F00h.
- SX Subindex for access via EtherCAT with Index 5005h.
- More can be found in the according manual of your bus coupler.

Name	Bytes	Function	Default	DS	IX	SX
ERR_A	1	Diagnostic	00h	01h	2F01h	02h
MODTYP	1	Module information	15h			03h
ERR_C	1	reserved	00h			04h
ERR_D	1	Diagnostic	00h			05h
CHTYP	1	Channel type	71h			06h
NUMBIT	1	Number diagnostic bits per channel	08h			07h
NUMCH	1	Number of channels of a module	04h			08h
CHERR	1	Channel error	00h			09h
CH0ERR	1	Channel-specific error channel 0	00h			0Ah
CH1ERR	1	Channel-specific error channel 1	00h			0Bh
CH2ERR	1	Channel-specific error channel 2	00h			0Ch
CH3ERR	1	Channel-specific error channel 3	00h			0Dh
CH4ERR...CH7 ERR	4	reserved	00h			0Eh ... 11h
DIAG_US	4	µs ticker	00h			13h

**ERR\_A Diagnostic**

Byte	Bit 7 ... 0
0	<ul style="list-style-type: none"> <li>■ Bit 0: set at module failure</li> <li>■ Bit 1: set at internal error</li> <li>■ Bit 2: set at external error</li> <li>■ Bit 3: set at channel error</li> <li>■ Bit 4: set at external auxiliary supply missing</li> <li>■ Bit 6 ... 5: reserved</li> <li>■ Bit 7: set at error in parametrization</li> </ul>

**MODTYP  
Module information**

Byte	Bit 7 ... 0
0	<ul style="list-style-type: none"> <li>■ Bit 3 ... 0: module class <ul style="list-style-type: none"> <li>– 0101b analog module</li> </ul> </li> <li>■ Bit 4: set at channel information present</li> <li>■ Bit 7 ... 5: reserved</li> </ul>

**ERR\_D Diagnostic**

Byte	Bit 7 ... 0
0	<ul style="list-style-type: none"> <li>■ Bit 2 ... 0: reserved</li> <li>■ Bit 3: set at internal diagnostics buffer overflow</li> <li>■ Bit 4: set at internal communication error</li> <li>■ Bit 7 ... 5: reserved</li> </ul>

**CHTYP Channel type**

Byte	Bit 7 ... 0
0	<ul style="list-style-type: none"> <li>■ Bit 6 ... 0: Channel type <ul style="list-style-type: none"> <li>- 70h: Digital input</li> <li>- 71h: Analog input</li> <li>- 72h: Digital output</li> <li>- 73h: Analog output</li> <li>- 74h: Analog input/-output</li> <li>- 76h: Counter</li> </ul> </li> <li>■ Bit 7: reserved</li> </ul>

**NUMBIT Diagnostic bits**

Byte	Bit 7 ... 0
0	Number of diagnostic bits per channel (here 08h)

**NUMCH Channels**

Byte	Bit 7 ... 0
0	Number of channels of a module (here 04h)

**CHERR Channel error**

Byte	Bit 7 ... 0
0	<ul style="list-style-type: none"> <li>■ Bit 0: set at error in channel group 0</li> <li>■ Bit 1: set at error in channel group 1</li> <li>■ Bit 2: set at error in channel group 2</li> <li>■ Bit 3: set at error in channel group 3</li> <li>■ Bit 7 ... 4: reserved</li> </ul>

**CH0ERR ... CH3ERR  
Channel-specific**

Byte	Bit 7 ... 0
0	Channel-specific error channel x: <ul style="list-style-type: none"> <li>■ Bit 0: set at configuring/parameter assignment error</li> <li>■ Bit 5 ... 1: reserved</li> <li>■ Bit 6: set at measuring range underflow</li> <li>■ Bit 7: set at measuring range overflow</li> </ul>

**CH4ERR ... CH7ERR  
reserved**

Byte	Bit 7 ... 0
0	reserved

031-1BD30 - AI 4x12Bit 0...10V > Diagnostic data

**DIAG\_US  $\mu$ s ticker**

Byte	Bit 7 ... 0
0...3	Value of the $\mu$ s ticker at the moment of the diagnostic

*$\mu$ s ticker*

In the System SLIO module there is a timer ( $\mu$ s ticker). With PowerON the timer starts counting with 0. After  $2^{32}-1\mu$ s the timer starts with 0 again.



### 3.11 031-1BD40 - AI 4x12Bit 0(4)...20mA

**Properties**

The electronic module has 4 inputs with parameterizable functions. The channels of the module are electrically isolated from the backplane bus. In addition, the channels are isolated to the DC 24V power supply by means of DC/DC converter.

- 4 analog inputs
- Suited for sensors with 0 ... 20mA;  
4 ... 20mA with external supply
- Diagnostics function
- 12bit resolution

**Structure**

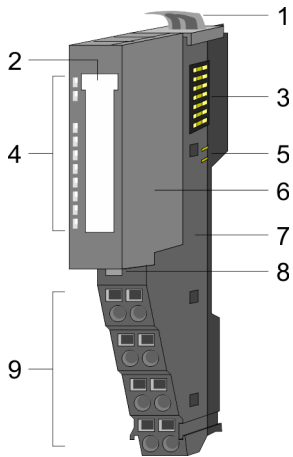

- 1 Locking lever terminal module
- 2 Labeling strip
- 3 Backplane bus
- 4 LED status indication
- 5 DC 24V power section supply
- 6 Electronic module
- 7 Terminal module
- 8 Locking lever electronic module
- 9 Terminal

**Status indication**

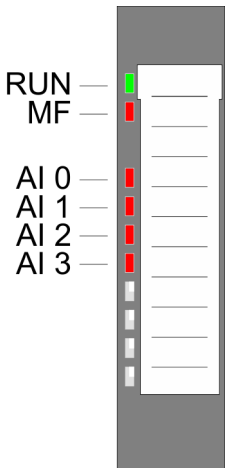

RUN	MF	AI x	Description
<input checked="" type="checkbox"/> green	<input checked="" type="checkbox"/> red	<input checked="" type="checkbox"/> red	
<input checked="" type="checkbox"/>	<input type="checkbox"/>	X	Bus communication is OK Module status is OK
<input checked="" type="checkbox"/>	<input checked="" type="checkbox"/>	X	Bus communication is OK Module status reports an error
<input type="checkbox"/>	<input checked="" type="checkbox"/>	X	Bus communication is not possible Module status reports an error
<input type="checkbox"/>	<input type="checkbox"/>	X	Error at bus power supply
X	<input checked="" type="checkbox"/>	X	Error in configuration → <a href="#">'Trouble shooting - LEDs'...page 41</a>
<input checked="" type="checkbox"/>	<input type="checkbox"/>	<input checked="" type="checkbox"/>	Error channel x <ul style="list-style-type: none"> <li>■ Signal leaves measuring range</li> <li>■ Error in parameterization</li> </ul>
not relevant: X			

031-1BD40 - AI 4x12Bit 0(4)...20mA

Pin assignment

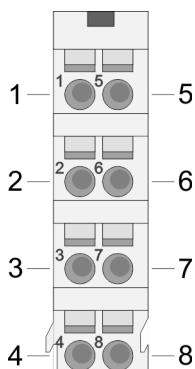

For wires with a cross section of 0.08mm<sup>2</sup> up to 1.5mm<sup>2</sup>.

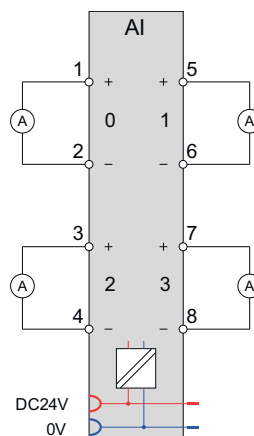

Pos.	Function	Type	Description
1	+AI 0	I	+ Channel 0
2	-AI 0	I	Ground Channel 0
3	+AI 2	I	+ Channel 2
4	-AI 2	I	Ground Channel 2
5	+AI 1	I	+ Channel 1
6	-AI 1	I	Ground Channel 1
7	+AI 3	I	+ Channel 3
8	-AI 3	I	Ground Channel 3

I: Input



*If a 2wire measuring transducer is used, you have to connect in line an external power supply.*

In-/Output area

At CPU, PROFIBUS and PROFINET the input respectively output area is embedded to the corresponding address area.

IX Index for access via CANopen with s = Subindex, depends on number and type of analog modules

SX Subindex for access via EtherCAT with Index 6000h + EtherCAT-Slot

More can be found in the according manual of your bus coupler.

Input area

Addr.	Name	Bytes	Function	IX	SX
+0	AI 0	2	Analog value channel 0	6401h/s	01h
+2	AI 1	2	Analog value channel 1	6401h/s+1	02h
+4	AI 2	2	Analog value channel 2	6401h/s+2	03h
+6	AI 3	2	Analog value channel 3	6401h/s+3	04h

Output area

No byte of the output area is used by the module.

## 3.11.1 Technical data

<b>Order no.</b>	<b>031-1BD40</b>
Type	SM 031 - Analog input
Module ID	0405 15C4
<b>Current consumption/power loss</b>	
Current consumption from backplane bus	75 mA
Power loss	0.7 W
<b>Technical data analog inputs</b>	
Number of inputs	4
Cable length, shielded	200 m
Rated load voltage	DC 24 V
Current consumption from load voltage L+ (without load)	15 mA
Voltage inputs	-
Min. input resistance (voltage range)	-
Input voltage ranges	-
Operational limit of voltage ranges	-
Operational limit of voltage ranges with SFU	-
Basic error limit voltage ranges	-
Basic error limit voltage ranges with SFU	-
Destruction limit voltage	-
Current inputs	✓
Max. input resistance (current range)	110 Ω
Input current ranges	0 mA ... +20 mA +4 mA ... +20 mA
Operational limit of current ranges	+/-0.3% ... +/-0.5%
Operational limit of current ranges with SFU	-
Basic error limit current ranges	+/-0.2% ... +/-0.3%
Radical error limit current ranges with SFU	-
Destruction limit current inputs (voltage)	max. 24V
Destruction limit current inputs (electrical current)	max. 40mA
Resistance inputs	-
Resistance ranges	-
Operational limit of resistor ranges	-
Operational limit of resistor ranges with SFU	-
Basic error limit	-
Basic error limit with SFU	-
Destruction limit resistance inputs	-
Resistance thermometer inputs	-
Resistance thermometer ranges	-

031-1BD40 - AI 4x12Bit 0(4)...20mA &gt; Technical data

Order no.	031-1BD40
Operational limit of resistance thermometer ranges	-
Operational limit of resistance thermometer ranges with SFU	-
Basic error limit thermoresistor ranges	-
Basic error limit thermoresistor ranges with SFU	-
Destruction limit resistance thermometer inputs	-
Thermocouple inputs	-
Thermocouple ranges	-
Operational limit of thermocouple ranges	-
Operational limit of thermocouple ranges with SFU	-
Basic error limit thermocouple ranges	-
Basic error limit thermocouple ranges with SFU	-
Destruction limit thermocouple inputs	-
Programmable temperature compensation	-
External temperature compensation	-
Internal temperature compensation	-
Temperature error internal compensation	-
Technical unit of temperature measurement	-
Resolution in bit	12
Measurement principle	successive approximation
Basic conversion time	4 ms all channels
Noise suppression for frequency	>50dB at 50Hz (UCM<2V)
<b>Status information, alarms, diagnostics</b>	
Status display	yes
Interrupts	no
Process alarm	no
Diagnostic interrupt	no
Diagnostic functions	yes
Diagnostics information read-out	possible
Module state	green LED
Module error display	red LED
Channel error display	red LED per channel
<b>Isolation</b>	
Between channels	-
Between channels of groups to	-
Between channels and backplane bus	✓
Between channels and power supply	✓
Max. potential difference between circuits	-

Order no.	031-1BD40
Max. potential difference between inputs (Ucm)	DC 2 V
Max. potential difference between Mana and Mintern (Uiso)	-
Max. potential difference between inputs and Mana (Ucm)	-
Max. potential difference between inputs and Mintern (Uiso)	DC 75 V/ AC 50 V
Max. potential difference between Mintern and outputs	-
Insulation tested with	DC 500 V
<b>Technical data encoder supply</b>	
Number of outputs	-
Output voltage (typ)	-
Output voltage (rated value)	-
Short-circuit protection	-
Binding of potential	-
<b>Datasizes</b>	
Input bytes	8
Output bytes	0
Parameter bytes	8
Diagnostic bytes	20
<b>Housing</b>	
Material	PPE / PPE GF10
Mounting	Profile rail 35 mm
<b>Mechanical data</b>	
Dimensions (WxHxD)	12.9 mm x 109 mm x 76.5 mm
Net weight	60 g
Weight including accessories	60 g
Gross weight	75 g
<b>Environmental conditions</b>	
Operating temperature	0 °C to 60 °C
Storage temperature	-25 °C to 70 °C
<b>Certifications</b>	
UL certification	yes
KC certification	yes
UKCA certification	yes
ChinaRoHS certification	yes

SFU

Interference frequency suppression

## 3.11.2 Parameter data

DS Record set for access via CPU, PROFIBUS and PROFINET

IX Index for access via CANopen

SX Subindex for access via EtherCAT with Index 3100h + EtherCAT-Slot

More can be found in the according manual of your bus coupler.

Name	Bytes	Function	Default	DS	IX	SX
CH0FN	1	Function number channel 0	31h	80h	3100h	01h
CH1FN	1	Function number channel 1	31h	81h	3101h	02h
CH2FN	1	Function number channel 2	31h	82h	3102h	03h
CH3FN	1	Function number channel 3	31h	83h	3103h	04h

### CHxFN Function number channel x

Below there are the measuring ranges with corresponding function number listed, which were supported by the module. With FFh the corresponding channel is deactivated. The formulas listed here allow you to transform an evaluated measuring value (digital value) to a value assigned to the measuring range (analog value) and vice versa.

Meas. range Current 0(4) ... 20mA (funct. no.)	Current (I)	Decimal (D)	Hex	Range	Formulas
0 ... 20mA Siemens S7 format (31h)	0 ... 20mA	32511	7EFFh	overrange	$D = 27648 \cdot \frac{I}{20}$ $I = D \cdot \frac{20}{27648}$
	20mA	27648	6C00h	nominal range	
	10mA	13824	3600h		
	0mA	0	0000h		
	-3.52mA	-4864	ED00h	underrange	
0 ... 20mA Siemens S5 format (41h)	25.00mA	20480	5000h	overrange	$D = 16384 \cdot \frac{I}{20}$ $I = D \cdot \frac{20}{16384}$
	20mA	16384	4000h	nominal range	
	10mA	8192	2000h		
	0mA	0	0000h		
	-4,00mA	-3277	F333h	underrange	
4 ... 20mA Siemens S7 format (30h)	22.81mA	32511	7EFFh	overrange	$D = 27648 \cdot \frac{I-4}{16}$ $I = D \cdot \frac{16}{27648} + 4$
	20mA	27648	6C00h	nominal range	
	12mA	13824	3600h		
	4mA	0	0000h		
	1.19mA	-4864	ED00h	underrange	
4 ... 20mA Siemens S5 format (40h)	24.00mA	20480	5000h	overrange	$D = 16384 \cdot \frac{I-4}{16}$ $I = D \cdot \frac{16}{16384} + 4$
	20mA	16384	4000h	nominal range	
	12mA	8192	2000h		
	4mA	0	0000h		
	0.8mA	-3277	F333h	underrange	

### 3.11.3 Diagnostic data

So this module does not support diagnostic interrupt functions, the diagnostics data serve for information about this module. On error the corresponding channel LED of the module is activated and the error is registered in the diagnostics data.

The following errors are listed in the diagnostics data:

- Error in project engineering / parameterization
- Measuring range overflow
- Measuring range underflow

DS Record set for access via CPU, PROFIBUS and PROFINET. The access happens by DS 01h. Additionally the first 4 bytes may be accessed by DS 00h.

IX Index for access via CANopen. The access happens by IX 2F01h. Additionally the first 4 bytes may be accessed by IX 2F00h.

SX Subindex for access via EtherCAT with Index 5005h.

More can be found in the according manual of your bus coupler.

Name	Bytes	Function	Default	DS	IX	SX
ERR_A	1	Diagnostic	00h	01h	2F01h	02h
MODTYP	1	Module information	15h			03h
ERR_C	1	reserved	00h			04h
ERR_D	1	Diagnostic	00h			05h
CHTYP	1	Channel type	71h			06h
NUMBIT	1	Number diagnostic bits per channel	08h			07h
NUMCH	1	Number of channels of a module	04h			08h
CHERR	1	Channel error	00h			09h
CH0ERR	1	Channel-specific error channel 0	00h			0Ah
CH1ERR	1	Channel-specific error channel 1	00h			0Bh
CH2ERR	1	Channel-specific error channel 2	00h			0Ch
CH3ERR	1	Channel-specific error channel 3	00h			0Dh
CH4ERR ... CH7ERR	4	reserved	00h			0Eh ... 11h
DIAG_US	4	µs-Ticker	00h			13h

#### ERR\_A Diagnostic

Byte	Bit 7 ... 0
0	<ul style="list-style-type: none"> <li>■ Bit 0: set at module failure</li> <li>■ Bit 1: reserved</li> <li>■ Bit 2: set at external error</li> <li>■ Bit 3: set at channel error</li> <li>■ Bit 4: set at external auxiliary supply missing</li> <li>■ Bit 6 ... 5: reserved</li> <li>■ Bit 7: set at error in parametrization</li> </ul>

031-1BD40 - AI 4x12Bit 0(4)...20mA &gt; Diagnostic data

**MODTYP**  
**Module information**

Byte	Bit 7 ... 0
0	<ul style="list-style-type: none"> <li>■ Bit 3 ... 0: module class               <ul style="list-style-type: none"> <li>- 0101b analog module</li> </ul> </li> <li>■ Bit 4: set at channel information present</li> <li>■ Bit 7 ... 5: reserved</li> </ul>

**ERR\_D Diagnostic**

Byte	Bit 7 ... 0
0	<ul style="list-style-type: none"> <li>■ Bit 2 ... 0: reserved</li> <li>■ Bit 3: set at internal diagnostics buffer overflow</li> <li>■ Bit 4: set at internal communication error</li> <li>■ Bit 7 ... 5: reserved</li> </ul>

**CHTYP Channel type**

Byte	Bit 7 ... 0
0	<ul style="list-style-type: none"> <li>■ Bit 6 ... 0: Channel type               <ul style="list-style-type: none"> <li>- 70h: Digital input</li> <li>- 71h: Analog input</li> <li>- 72h: Digital output</li> <li>- 73h: Analog output</li> <li>- 74h: Analog input/-output</li> <li>- 76h: Counter</li> </ul> </li> <li>■ Bit 7: reserved</li> </ul>

**NUMBIT Diagnostic bits**

Byte	Bit 7 ... 0
0	Number of diagnostic bits per channel (here 08h)

**NUMCH Channels**

Byte	Bit 7 ... 0
0	Number of channels of a module (here 04h)

**CHERR Channel error**

Byte	Bit 7 ... 0
0	<ul style="list-style-type: none"> <li>■ Bit 0: set at error in channel group 0</li> <li>■ Bit 1: set at error in channel group 1</li> <li>■ Bit 2: set at error in channel group 2</li> <li>■ Bit 3: set at error in channel group 3</li> <li>■ Bit 7 ... 4: reserved</li> </ul>



**CH0ERR ... CH3ERR**  
*Channel-specific*

Byte	Bit 7 ... 0
0	Channel-specific error channel x: <ul style="list-style-type: none"> <li>■ Bit 0: set at configuring/parameter assignment error</li> <li>■ Bit 5 ... 1: reserved</li> <li>■ Bit 6: set at measuring range underflow</li> <li>■ Bit 7: set at measuring range overflow</li> </ul>

**CH4ERR ... CH7ERR**  
*reserved*

Byte	Bit 7 ... 0
0	reserved

**DIAG\_US** *µs ticker*

Byte	Bit 7 ... 0
0...3	Value of the µs ticker at the moment of the diagnostic

*µs ticker*

In the System SLIO module there is a timer (µs ticker). With PowerON the timer starts counting with 0. After  $2^{32}-1\mu\text{s}$  the timer starts with 0 again.

031-1BD70 - AI 4x12Bit ±10V

### 3.12 031-1BD70 - AI 4x12Bit ±10V

#### Properties

The electronic module has 4 inputs with parameterizable functions. The channels of the module are electrically isolated from the backplane bus. In addition, the channels are isolated to the DC 24V power supply by means of DC/DC converter.

- 4 analog inputs
- Suited for sensors with ±10V, 0 ... 10V
- Diagnostics function
- 12bit resolution

#### Structure

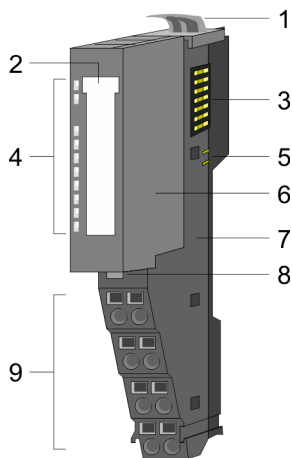

- 1 Locking lever terminal module
- 2 Labeling strip
- 3 Backplane bus
- 4 LED status indication
- 5 DC 24V power section supply
- 6 Electronic module
- 7 Terminal module
- 8 Locking lever electronic module
- 9 Terminal

#### Status indication

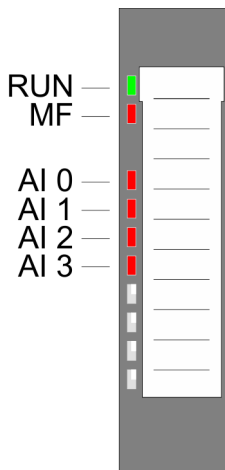

RUN	MF	AI x	Description
<input checked="" type="checkbox"/> green	<input checked="" type="checkbox"/> red	<input checked="" type="checkbox"/> red	
<input checked="" type="checkbox"/>	<input type="checkbox"/>	X	Bus communication is OK Module status is OK
<input checked="" type="checkbox"/>	<input checked="" type="checkbox"/>	X	Bus communication is OK Module status reports an error
<input type="checkbox"/>	<input checked="" type="checkbox"/>	X	Bus communication is not possible Module status reports an error
<input type="checkbox"/>	<input type="checkbox"/>	X	Error at bus power supply
X	<input checked="" type="checkbox"/>	X	Error in configuration → <a href="#">‘Trouble shooting - LEDs’...page 41</a>
<input checked="" type="checkbox"/>	<input type="checkbox"/>	<input checked="" type="checkbox"/>	Error channel x <ul style="list-style-type: none"> <li>■ Signal leaves measuring range</li> <li>■ Error in parameterization</li> </ul>
not relevant: X			

**Pin assignment**

For wires with a cross section of 0.08mm<sup>2</sup> up to 1.5mm<sup>2</sup>.

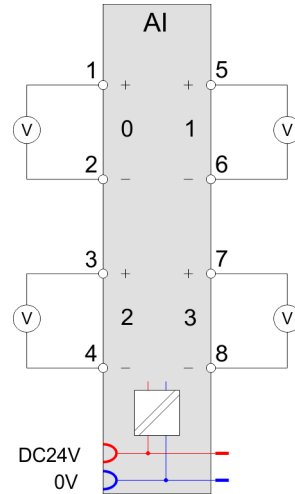
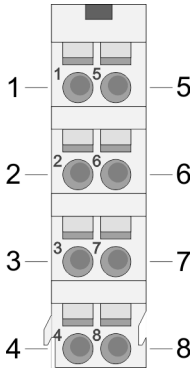

Pos.	Function	Type	Description
1	+AI 0	I	+ Channel 0
2	-AI 0	I	Ground Channel 0
3	+AI 2	I	+ Channel 2
4	-AI 2	I	Ground Channel 2
5	+AI 1	I	+ Channel 1
6	-AI 1	I	Ground Channel 1
7	+AI 3	I	+ Channel 3
8	-AI 3	I	Ground Channel 3

I: Input

**In-/Output area**

At CPU, PROFIBUS and PROFINET the input respectively output area is embedded to the corresponding address area.

IX Index for access via CANopen with s = Subindex, depends on number and type of analog modules

SX Subindex for access via EtherCAT with Index 6000h + EtherCAT-Slot

More can be found in the according manual of your bus coupler.

**Input area**

Addr.	Name	Bytes	Function	IX	SX
+0	AI 0	2	Analog value channel 0	6401h/s	01h
+2	AI 1	2	Analog value channel 1	6401h/s+1	02h
+4	AI 2	2	Analog value channel 2	6401h/s+2	03h
+6	AI 3	2	Analog value channel 3	6401h/s+3	04h

**Output area**

No byte of the output area is used by the module.

## 3.12.1 Technical data

Order no.	031-1BD70
Type	SM 031 - Analog input
Module ID	0409 15C4
<b>Current consumption/power loss</b>	
Current consumption from backplane bus	55 mA
Power loss	0.5 W
<b>Technical data analog inputs</b>	
Number of inputs	4
Cable length, shielded	200 m
Rated load voltage	DC 24 V
Current consumption from load voltage L+ (without load)	15 mA
Voltage inputs	✓
Min. input resistance (voltage range)	100 k $\Omega$
Input voltage ranges	-10 V ... +10 V 0 V ... +10 V
Operational limit of voltage ranges	+/-0.3%
Operational limit of voltage ranges with SFU	-
Basic error limit voltage ranges	+/-0.2%
Basic error limit voltage ranges with SFU	-
Destruction limit voltage	max. 30V
Current inputs	-
Max. input resistance (current range)	-
Input current ranges	-
Operational limit of current ranges	-
Operational limit of current ranges with SFU	-
Basic error limit current ranges	-
Radical error limit current ranges with SFU	-
Destruction limit current inputs (voltage)	-
Destruction limit current inputs (electrical current)	-
Resistance inputs	-
Resistance ranges	-
Operational limit of resistor ranges	-
Operational limit of resistor ranges with SFU	-
Basic error limit	-
Basic error limit with SFU	-
Destruction limit resistance inputs	-
Resistance thermometer inputs	-
Resistance thermometer ranges	-

Order no.	031-1BD70
Operational limit of resistance thermometer ranges	-
Operational limit of resistance thermometer ranges with SFU	-
Basic error limit thermoresistor ranges	-
Basic error limit thermoresistor ranges with SFU	-
Destruction limit resistance thermometer inputs	-
Thermocouple inputs	-
Thermocouple ranges	-
Operational limit of thermocouple ranges	-
Operational limit of thermocouple ranges with SFU	-
Basic error limit thermocouple ranges	-
Basic error limit thermocouple ranges with SFU	-
Destruction limit thermocouple inputs	-
Programmable temperature compensation	-
External temperature compensation	-
Internal temperature compensation	-
Temperature error internal compensation	-
Technical unit of temperature measurement	-
Resolution in bit	12
Measurement principle	successive approximation
Basic conversion time	4 ms all channels
Noise suppression for frequency	>50dB at 50Hz (UCM<2V)
<b>Status information, alarms, diagnostics</b>	
Status display	yes
Interrupts	no
Process alarm	no
Diagnostic interrupt	no
Diagnostic functions	yes
Diagnostics information read-out	possible
Module state	green LED
Module error display	red LED
Channel error display	red LED per channel
<b>Isolation</b>	
Between channels	-
Between channels of groups to	-
Between channels and backplane bus	✓
Between channels and power supply	✓
Max. potential difference between circuits	-

031-1BD70 - AI 4x12Bit  $\pm 10V$  > Technical data

Order no.	031-1BD70
Max. potential difference between inputs (Ucm)	DC 2 V
Max. potential difference between Mana and Mintern (Uiso)	-
Max. potential difference between inputs and Mana (Ucm)	-
Max. potential difference between inputs and Mintern (Uiso)	DC 75 V/ AC 50 V
Max. potential difference between Mintern and outputs	-
Insulation tested with	DC 500 V
<b>Technical data encoder supply</b>	
Number of outputs	-
Output voltage (typ)	-
Output voltage (rated value)	-
Short-circuit protection	-
Binding of potential	-
<b>Datasizes</b>	
Input bytes	8
Output bytes	0
Parameter bytes	8
Diagnostic bytes	20
<b>Housing</b>	
Material	PPE / PPE GF10
Mounting	Profile rail 35 mm
<b>Mechanical data</b>	
Dimensions (WxHxD)	12.9 mm x 109 mm x 76.5 mm
Net weight	60 g
Weight including accessories	60 g
Gross weight	75 g
<b>Environmental conditions</b>	
Operating temperature	0 °C to 60 °C
Storage temperature	-25 °C to 70 °C
<b>Certifications</b>	
UL certification	yes
KC certification	yes
UKCA certification	yes
ChinaRoHS certification	yes

SFU

Interference frequency suppression

3.12.2 Parameter data

- DS Record set for access via CPU, PROFIBUS and PROFINET
  - IX Index for access via CANopen
  - SX Subindex for access via EtherCAT with Index 3100h + EtherCAT-Slot
- More can be found in the according manual of your bus coupler.

Name	Bytes	Function	Default	DS	IX	SX
CH0FN	1	Function number channel 0	12h	80h	3100h	01h
CH1FN	1	Function number channel 1	12h	81h	3101h	02h
CH2FN	1	Function number channel 2	12h	82h	3102h	03h
CH3FN	1	Function number channel 3	12h	83h	3103h	04h

**CHxFN Function number channel x**

In the following there are the measuring ranges with corresponding function number listed, which were supported by the analog module. With FFh the corresponding channel is deactivated. The formulas listed here allow you to transform an evaluated measuring value (digital value) to a value assigned to the measuring range (analog value) and vice versa.

Meas. range Voltage ±10V (funct. no.)	Voltage (U)	Decimal (D)	Hex	Range	Formulas
±10V Siemens S7 format (12h)	11.76V	32511	7EFFh	overrange	$D = 27648 \cdot \frac{U}{10}$ $U = D \cdot \frac{10}{27648}$
	10V	27648	6C00h	nominal range	
	5V	13824	3600h		
	0V	0	0000h		
	-5V	-13824	CA00h		
	-10V	-27648	9400h		
	-11.76V	-32512	8100h	underrange	
±10V Siemens S5 format (22h)	12.5V	20480	5000h	overrange	$D = 16384 \cdot \frac{U}{10}$ $U = D \cdot \frac{10}{16384}$
	10V	16384	4000h	nominal range	
	5V	8192	2000h		
	0V	0	0000h		
	-5V	-8192	E000h		
	-10V	-16384	C000h		
	-12.5V	-20480	B000h	underrange	

031-1BD70 - AI 4x12Bit ±10V &gt; Diagnostic data

Meas. range Voltage 0 ... 10V (funct. no.)	Voltage (U)	Decimal (D)	Hex	Range	Formulas
0 ... 10V Siemens S7 format (10h)	11.76V	32511	7EFFh	overrange	$D = 27648 \cdot \frac{U}{10}$ $U = D \cdot \frac{10}{27648}$
	10V	27648	6C00h	nominal range	
	5V	13824	3600h		
	0V	0	0000h		
	-1.76V	-4864	ED00h	underrange	
0 ... 10V Siemens S5 format (20h)	12.5V	20480	5000h	overrange	$D = 16384 \cdot \frac{U}{10}$ $U = D \cdot \frac{10}{16384}$
	10V	16384	4000h	nominal range	
	5V	8192	2000h		
	0V	0	0000h		
	-2V	-3277	F333h	underrange	

### 3.12.3 Diagnostic data

So this module does not support diagnostic interrupt functions, the diagnostics data serve for information about this module. On error the corresponding channel LED of the module is activated and the error is registered in the diagnostics data.

The following errors are listed in the diagnostics data:

- Error in project engineering / parameterization
- Measuring range overflow
- Measuring range underflow

DS Record set for access via CPU, PROFIBUS and PROFINET. The access happens by DS 01h. Additionally the first 4 bytes may be accessed by DS 00h.

IX Index for access via CANopen. The access happens by IX 2F01h. Additionally the first 4 bytes may be accessed by IX 2F00h.

SX Subindex for access via EtherCAT with Index 5005h.

More can be found in the according manual of your bus coupler.



Name	Bytes	Function	Default	DS	IX	SX
ERR_A	1	Diagnostic	00h	01h	2F01h	02h
MODTYP	1	Module information	15h			03h
ERR_C	1	reserved	00h			04h
ERR_D	1	Diagnostic	00h			05h
CHTYP	1	Channel type	71h			06h
NUMBIT	1	Number diagnostic bits per channel	08h			07h
NUMCH	1	Number of channels of a module	04h			08h
CHERR	1	Channel error	00h			09h
CH0ERR	1	Channel-specific error channel 0	00h			0Ah
CH1ERR	1	Channel-specific error channel 1	00h			0Bh
CH2ERR	1	Channel-specific error channel 2	00h			0Ch
CH3ERR	1	Channel-specific error channel 3	00h			0Dh
CH4ERR...CH7 ERR	4	reserved	00h			0Eh ... 11h
DIAG_US	4	µs ticker	00h			13h

**ERR\_A Diagnostic**

Byte	Bit 7 ... 0
0	<ul style="list-style-type: none"> <li>■ Bit 0: set at module failure</li> <li>■ Bit 1: set at internal error</li> <li>■ Bit 2: set at external error</li> <li>■ Bit 3: set at channel error</li> <li>■ Bit 4: set at external auxiliary supply missing</li> <li>■ Bit 6 ... 5: reserved</li> <li>■ Bit 7: set at error in parametrization</li> </ul>

**MODTYP  
Module information**

Byte	Bit 7 ... 0
0	<ul style="list-style-type: none"> <li>■ Bit 3 ... 0: module class <ul style="list-style-type: none"> <li>– 0101b analog module</li> </ul> </li> <li>■ Bit 4: set at channel information present</li> <li>■ Bit 7 ... 5: reserved</li> </ul>

**ERR\_D Diagnostic**

Byte	Bit 7 ... 0
0	<ul style="list-style-type: none"> <li>■ Bit 2 ... 0: reserved</li> <li>■ Bit 3: set at internal diagnostics buffer overflow</li> <li>■ Bit 4: set at internal communication error</li> <li>■ Bit 7 ... 5: reserved</li> </ul>

031-1BD70 - AI 4x12Bit  $\pm 10V$  > Diagnostic data**CHTYP Channel type**

Byte	Bit 7 ... 0
0	<ul style="list-style-type: none"> <li>■ Bit 6 ... 0: Channel type               <ul style="list-style-type: none"> <li>- 70h: Digital input</li> <li>- 71h: Analog input</li> <li>- 72h: Digital output</li> <li>- 73h: Analog output</li> <li>- 74h: Analog input/-output</li> <li>- 76h: Counter</li> </ul> </li> <li>■ Bit 7: reserved</li> </ul>

**NUMBIT Diagnostic bits**

Byte	Bit 7 ... 0
0	Number of diagnostic bits per channel (here 08h)

**NUMCH Channels**

Byte	Bit 7 ... 0
0	Number of channels of a module (here 04h)

**CHERR Channel error**

Byte	Bit 7 ... 0
0	<ul style="list-style-type: none"> <li>■ Bit 0: set at error in channel group 0</li> <li>■ Bit 1: set at error in channel group 1</li> <li>■ Bit 2: set at error in channel group 2</li> <li>■ Bit 3: set at error in channel group 3</li> <li>■ Bit 7 ... 4: reserved</li> </ul>

**CH0ERR ... CH3ERR  
Channel-specific**

Byte	Bit 7 ... 0
0	Channel-specific error channel x: <ul style="list-style-type: none"> <li>■ Bit 0: set at configuring/parameter assignment error</li> <li>■ Bit 5 ... 1: reserved</li> <li>■ Bit 6: set at measuring range underflow</li> <li>■ Bit 7: set at measuring range overflow</li> </ul>

**CH4ERR ... CH7ERR  
reserved**

Byte	Bit 7 ... 0
0	reserved

**DIAG\_US  $\mu$ s ticker**

Byte	Bit 7 ... 0
0...3	Value of the $\mu$ s ticker at the moment of the diagnostic

 *$\mu$ s ticker*

In the System SLIO module there is a timer ( $\mu$ s ticker). With PowerON the timer starts counting with 0. After  $2^{32}-1\mu$ s the timer starts with 0 again.

### 3.13 031-1BD80 - AI 4x16Bit R/RTD

**Properties**

The electronic module has 4 inputs for resistance measurement with parameterizable functions. The channels of the module are isolated to the backplane bus.

- 4 analog inputs
- Suited for resistance-type sensors 0 ... 3000Ω and resistance temperature sensors Pt100, Pt1000, NI100, NI120 and NI1000
- Resistance measurement with 2, 3 and 4 wire (3 and 4 wire only via channel 0 respectively 1)
- Interrupt and diagnostics function
- 16bit resolution

**Structure**

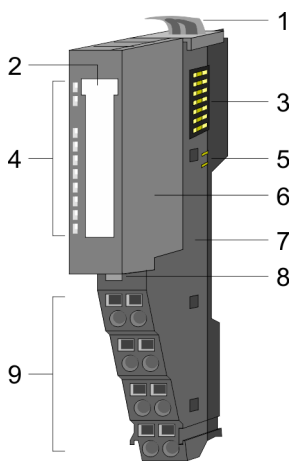

- 1 Locking lever terminal module
- 2 Labeling strip
- 3 Backplane bus
- 4 LED status indication
- 5 DC 24V power section supply
- 6 Electronic module
- 7 Terminal module
- 8 Locking lever electronic module
- 9 Terminal

**Status indication**

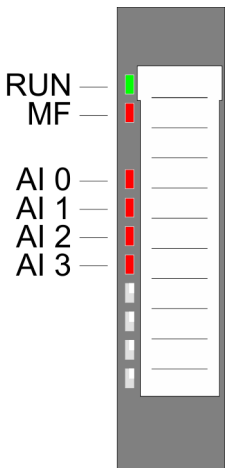

RUN	MF	AI x	Description
green	red	red	
■	□	X	Bus communication is OK Module status is OK
■	■	X	Bus communication is OK Module status reports an error
□	■	X	Bus communication is not possible Module status reports an error
□	□	X	Error at bus power supply
X	▣	X	Error in configuration → <a href="#">‘Trouble shooting - LEDs’...page 41</a>
■	□	■	Error channel x <ul style="list-style-type: none"> <li>■ Signal leaves measuring range</li> <li>■ Error in parameterization</li> <li>■ Wire break (if parameterized)</li> </ul>
not relevant: X			

**Pin assignment**

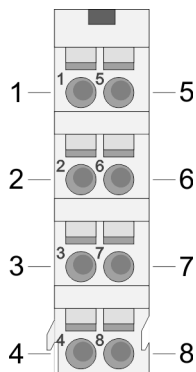

For wires with a cross section of 0.08mm<sup>2</sup> up to 1.5mm<sup>2</sup>.

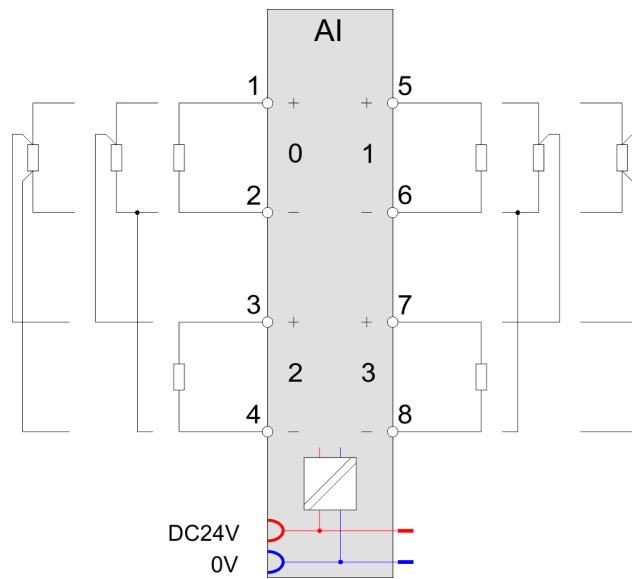

Pos.	Function	Type	Description
1	+AI 0	I	+ Channel 0
2	-AI 0	I	Ground Channel 0
3	+AI 2	I	+ Channel 2
4	-AI 2	I	Ground Channel 2
5	+AI 1	I	+ Channel 1
6	-AI 1	I	Ground Channel 1
7	+AI 3	I	+ Channel 3
8	-AI 3	I	Ground Channel 3

I: Input

**2, 3, 4 wire measurement**

At the pin assignment above you can see how the sensors are to be connected at 2, 3 respectively 4 wire measurement.

- With every channel a 2 wire measurement may be performed.
- 3 wire measurement is only possible via the channels 0 and 1.
  - Please consider with 3 wire measurement that the corresponding channel is always deactivated in the parametrization. The corresponding channel of channel 0 is channel 2 and of channel 1 is channel 3. Not used channels must always be de-activated in the parametrization.
- 4 wire measurement is only possible via the channels 0 and 1.
  - The measurement current for channel 0 is applied at pin 1 and 2. The measurement for channel 0 happens at pin 3 and 4. The analog value for channel 0 is represented in input word 0.
  - The measurement current for channel 1 is applied at pin 5 and 6. The measurement for channel 1 happens at pin 7 and 8. The analog value for channel 1 is represented in input word 1.
  - Please consider with 4 wire measurement that the corresponding channel is always deactivated in the parametrization. The corresponding channel of channel 0 is channel 2 and of channel 1 is channel 3. Not used channels must always be de-activated in the parametrization.

**In-/Output area**

At CPU, PROFIBUS and PROFINET the input respectively output area is embedded to the corresponding address area.

IX Index for access via CANopen with s = Subindex, depends on number and type of analog modules

SX Subindex for access via EtherCAT with Index 6000h + EtherCAT-Slot

More can be found in the according manual of your bus coupler.

**Input area**

Addr.	Name	Bytes	Function	IX	SX
+0	AI 0	2	Analog value channel 0	6401h/s	01h
+2	AI 1	2	Analog value channel 1	6401h/s+1	02h
+4	AI 2	2	Analog value channel 2	6401h/s+2	03h
+6	AI 3	2	Analog value channel 3	6401h/s+3	04h

**Output area**

No byte of the output area is used by the module.

**3.13.1 Technical data**

<b>Order no.</b>	<b>031-1BD80</b>
Type	SM 031 - Analog input
Module ID	0406 1544
<b>Current consumption/power loss</b>	
Current consumption from backplane bus	85 mA
Power loss	1 W
<b>Technical data analog inputs</b>	
Number of inputs	4
Cable length, shielded	200 m
Rated load voltage	DC 24 V
Current consumption from load voltage L+ (without load)	30 mA
Voltage inputs	-
Min. input resistance (voltage range)	-
Input voltage ranges	-
Operational limit of voltage ranges	-
Operational limit of voltage ranges with SFU	-
Basic error limit voltage ranges	-
Basic error limit voltage ranges with SFU	-
Destruction limit voltage	-
Current inputs	-
Max. input resistance (current range)	-
Input current ranges	-
Operational limit of current ranges	-
Operational limit of current ranges with SFU	-

Order no.	031-1BD80
Basic error limit current ranges	-
Radical error limit current ranges with SFU	-
Destruction limit current inputs (voltage)	-
Destruction limit current inputs (electrical current)	-
Resistance inputs	✓
Resistance ranges	0 ... 60 Ohm 0 ... 600 Ohm 0 ... 3000 Ohm
Operational limit of resistor ranges	+/- 0.4 %
Operational limit of resistor ranges with SFU	+/- 0.2 %
Basic error limit	+/- 0.2 %
Basic error limit with SFU	+/- 0.1 %
Destruction limit resistance inputs	max. 24V
Resistance thermometer inputs	✓
Resistance thermometer ranges	Pt100 Pt1000 Ni100 Ni120 Ni1000
Operational limit of resistance thermometer ranges	+/- 0.4 %
Operational limit of resistance thermometer ranges with SFU	+/- 0.2 %
Basic error limit thermoresistor ranges	+/- 0.2 %
Basic error limit thermoresistor ranges with SFU	+/- 0.1 %
Destruction limit resistance thermometer inputs	max. 24V
Thermocouple inputs	-
Thermocouple ranges	-
Operational limit of thermocouple ranges	-
Operational limit of thermocouple ranges with SFU	-
Basic error limit thermocouple ranges	-
Basic error limit thermocouple ranges with SFU	-
Destruction limit thermocouple inputs	-
Programmable temperature compensation	-
External temperature compensation	-
Internal temperature compensation	-
Temperature error internal compensation	-
Technical unit of temperature measurement	°C, °F, K
Resolution in bit	16

Order no.	031-1BD80
Measurement principle	Sigma-Delta
Basic conversion time	4.2...324.1 ms (50 Hz) 3.8...270.5 ms (60 Hz) per channel
Noise suppression for frequency	>80dB at 50Hz (UCM<6V)
<b>Status information, alarms, diagnostics</b>	
Status display	yes
Interrupts	yes, parameterizable
Process alarm	yes, parameterizable
Diagnostic interrupt	yes, parameterizable
Diagnostic functions	yes
Diagnostics information read-out	possible
Module state	green LED
Module error display	red LED
Channel error display	red LED per channel
<b>Isolation</b>	
Between channels	-
Between channels of groups to	-
Between channels and backplane bus	✓
Between channels and power supply	-
Max. potential difference between circuits	-
Max. potential difference between inputs (Ucm)	DC 6 V
Max. potential difference between Mana and Mintern (Uiso)	-
Max. potential difference between inputs and Mana (Ucm)	-
Max. potential difference between inputs and Mintern (Uiso)	DC 75 V/ AC 50 V
Max. potential difference between Mintern and outputs	-
Insulation tested with	DC 500 V
<b>Technical data encoder supply</b>	
Number of outputs	-
Output voltage (typ)	-
Output voltage (rated value)	-
Short-circuit protection	-
Binding of potential	-
<b>Datasizes</b>	
Input bytes	8
Output bytes	0
Parameter bytes	34
Diagnostic bytes	20

031-1BD80 - AI 4x16Bit R/RTD &gt; Technical data

<b>Order no.</b>	<b>031-1BD80</b>
<b>Housing</b>	
Material	PPE / PPE GF10
Mounting	Profile rail 35 mm
<b>Mechanical data</b>	
Dimensions (WxHxD)	12.9 mm x 109 mm x 76.5 mm
Net weight	61 g
Weight including accessories	61 g
Gross weight	75 g
<b>Environmental conditions</b>	
Operating temperature	0 °C to 60 °C
Storage temperature	-25 °C to 70 °C
<b>Certifications</b>	
UL certification	yes
KC certification	yes
UKCA certification	yes
ChinaRoHS certification	yes

SFU

Interference frequency suppression



## 3.13.2 Parameter data

DS Record set for access via CPU, PROFIBUS and PROFINET  
 IX Index for access via CANopen  
 SX Subindex for access via EtherCAT with Index 3100h + EtherCAT-Slot  
 More can be found in the according manual of your bus coupler.

Name	Bytes	Function	Default	DS	IX	SX
DIAG_EN	1	Diagnostics <sup>1</sup>	00h	00h	3100h	01h
WIBRK_EN	1	Wire break recognition <sup>1</sup>	00h	00h	3101h	02h
LIMIT_EN	1	Limit value monitoring <sup>1</sup>	00h	00h	3102h	03h
RES3	1	reserved	00h	00h	3103h	04h
TEMPCNF	1	Temperature system	00h	01h	3104h	05h
SUPR	1	Interference frequency suppression (SFU)	02h	01h	3105h	06h
CH0FN	1	Function number channel 0	50h	80h	3106h	07h
CH0FO	1	Function option channel 0	00h	80h	3107h	08h
CH0UL	2	Upper limit value channel 0	7FFFh	80h	3108h... 3109h	09h
CH0LL	2	Lower limit value channel 0	8000h	80h	310Ah... 310Bh	0Ah
CH1FN	1	Function number channel 1	50h	81h	310Ch	0Bh
CH1FO	1	Function option channel 1	00h	81h	310Dh	0Ch
CH1UL	2	Upper limit value channel 1	7FFFh	81h	310Eh... 310Fh	0Dh
CH1LL	2	Lower limit value channel 1	8000h	81h	3110h... 3111h	0Eh
CH2FN	1	Function number channel 2	50h <sup>2</sup>	82h	3112h	0Fh
CH2FO	1	Function option channel 2	00h	82h	3113h	10h
CH2UL	2	Upper limit value channel 2	7FFFh	82h	3114h... 3115h	11h
CH2LL	2	Lower limit value channel 2	8000h	82h	3116h... 3117h	12h
CH3FN	1	Function number channel 3	50h <sup>2</sup>	83h	3118h	13h
CH3FO	1	Function option channel 3	00h	83h	3119h	14h
CH3UL	2	Upper limit value channel 3	7FFFh	83h	311Ah... 311Bh	15h
CH3LL	2	Lower limit value channel 3	8000h	83h	311Ch... 311Dh	16h

1) This record set may only be transferred at STOP state.

2) with 2 channel operation FFh

031-1BD80 - AI 4x16Bit R/RTD &gt; Parameter data

**DIAG\_EN**  
Diagnostic interrupt

Byte	Bit 7 ... 0
0	<ul style="list-style-type: none"> <li>■ Diagnostic interrupt               <ul style="list-style-type: none"> <li>- 00h: disabled</li> <li>- 40h: enabled</li> </ul> </li> </ul>

- Here you can enable respectively disable the diagnostic interrupt.

**WIBRK\_EN**  
Wire break recognition

Byte	Bit 7 ... 0
0	<ul style="list-style-type: none"> <li>■ Bit 0: Wire break recognition channel 0 (1: on)</li> <li>■ Bit 1: Wire break recognition channel 1 (1: on)</li> <li>■ Bit 2: Wire break recognition channel 2 (1: on)</li> <li>■ Bit 3: Wire break recognition channel 3 (1: on)</li> <li>■ Bit 7 ... 4: reserved</li> </ul>

**LIMIT\_EN**  
Limit value monitoring

Byte	Bit 7 ... 0
0	<ul style="list-style-type: none"> <li>■ Bit 0: Limit value monitoring channel 0 (1: on)</li> <li>■ Bit 1: Limit value monitoring channel 1 (1: on)</li> <li>■ Bit 2: Limit value monitoring channel 2 (1: on)</li> <li>■ Bit 3: Limit value monitoring channel 3 (1: on)</li> <li>■ Bit 7 ... 4: reserved</li> </ul>

**TEMPCNF** Temperature system

Byte	Bit 7 ... 0
0	<ul style="list-style-type: none"> <li>■ Bit 0, 1: Temperature system               <ul style="list-style-type: none"> <li>- 00: °C</li> <li>- 01: °F</li> <li>- 10: K</li> </ul> </li> <li>■ Bit 7 ... 2: reserved</li> </ul>

**SUPR** Interference frequency suppression (SFU)

Byte	Bit 7 ... 0
0	<ul style="list-style-type: none"> <li>■ Bit 0, 1: Interference frequency suppression               <ul style="list-style-type: none"> <li>- 01: 60Hz</li> <li>- 10: 50Hz</li> </ul> </li> <li>■ Bit 7 ... 2: reserved</li> </ul>

**CHxFN** Function number channel x

In the following there are the measuring ranges with corresponding function number listed, which were supported by the analog module. With FFh the corresponding channel is deactivated.

Measuring range Resistance (funct. no.)	Measuring value	Signal range	Range
2 wire: PT100 (50h)	+1000°C	+10000	overrange
	-200 ... +850°C	-2000 ... +8500	nominal range
	-243°C	-2430	underrange
2 wire: PT1000 (51h)	+1000°C	+10000	overrange
	-200 ... +850°C	-2000 ... +8500	nominal range
	-243°C	-2430	underrange
2 wire: NI100 (52h)	+295°C	+2950	overrange
	-60 ... +250°C	-600 ... +2500	nominal range
	-105°C	-1050	underrange
2 wire: NI1000 (53h)	+295°C	+2950	overrange
	-60 ... +250°C	-600 ... +2500	nominal range
	-105°C	-1050	underrange
2 wire: NI120 <sup>1</sup> (54h)	+400°C	+4000	overrange
	-80 ... +320°C	-800 ... +3200	nominal range
	-100°C	-1000	underrange
3 wire: PT100 (58h)	+1000°C	+10000	overrange
	-200 ... +850°C	-2000 ... +8500	nominal range
	-243°C	-2430	underrange
3 wire: PT1000 (59h)	+1000°C	+10000	overrange
	-200 ... +850°C	-2000 ... +8500	nominal range
	-243°C	-2430	underrange
3 wire: NI100 (5Ah)	+295°C	+2950	overrange
	-60 ... +250°C	-600 ... +2500	nominal range
	-105°C	-1050	underrange
3 wire: NI1000 (5Bh)	+295°C	+2950	overrange
	-60 ... +250°C	-600 ... +2500	nominal range
	-105°C	-1050	underrange
3 wire: NI120 <sup>1</sup> (5Ch)	+400°C	+4000	overrange
	-80 ... +320°C	-800 ... +3200	nominal range
	-100°C	-1000	underrange
4 wire: PT100 (60h)	+1000°C	+10000	overrange
	-200 ... +850°C	-2000 ... +8500	nominal range
	-243°C	-2430	underrange
4 wire: PT1000 (61h)	+1000°C	+10000	overrange
	-200 ... +850°C	-2000 ... +8500	nominal range
	-243°C	-2430	underrange
4 wire: NI100	+295°C	+2950	overrange

031-1BD80 - AI 4x16Bit R/RTD &gt; Parameter data

Measuring range Resistance (funct. no.)	Measuring value	Signal range	Range
(62h)	-60 ... +250°C	-600 ... +2500	nominal range
	-105°C	-1050	underrange
4 wire: NI1000 (63h)	+295°C	+2950	overrange
	-60 ... +250°C	-600 ... +2500	nominal range
4 wire: NI120 <sup>1</sup> (64h)	+400°C	+4000	overrange
	-80 ... +320°C	-800 ... +3200	nominal range
2 wire: 0 ... 60Ω (70h)	---	---	underrange
	0 ... 60Ω	0 ... 32767	nominal range
2 wire: 0 ... 600Ω (71h)	---	---	underrange
	0 ... 600Ω	0 ... 32767	nominal range
2 wire: 0 ... 3000Ω (72h)	---	---	underrange
	0 ... 3000Ω	0 ... 32767	nominal range
3 wire: 0 ... 60Ω (78h)	---	---	underrange
	0 ... 60Ω	0 ... 32767	nominal range
3 wire: 0 ... 600Ω (79h)	---	---	underrange
	0 ... 600Ω	0 ... 32767	nominal range
3 wire: 0 ... 3000Ω (7Ah)	---	---	underrange
	0 ... 3000Ω	0 ... 32767	nominal range
4 wire: 0 ... 60Ω (80h)	---	---	underrange
	0 ... 60Ω	0 ... 32767	nominal range
4 wire: 0 ... 600Ω (81h)	---	---	underrange
	0 ... 600Ω	0 ... 32767	nominal range
4 wire: 0 ... 3000Ω (82h)	---	---	underrange
	0 ... 3000Ω	0 ... 32767	nominal range
2 wire: 0 ... 60Ω (90h)	---	---	underrange
	0 ... 60Ω	0 ... 6000	nominal range

Measuring range Resistance (funct. no.)	Measuring value	Signal range	Range
	---	---	underrange
2 wire: 0 ... 600Ω (91h)	---	---	overrange
	0 ... 600Ω	0 ... 6000	nominal range
	---	---	underrange
2 wire: 0 ... 3000Ω (92h)	---	---	overrange
	0 ... 3000Ω	0 ... 30000	nominal range
	---	---	underrange
3 wire: 0 ... 60Ω (98h)	---	---	overrange
	0 ... 60Ω	0 ... 6000	nominal range
	---	---	underrange
3 wire: 0 ... 600Ω (99h)	---	---	overrange
	0 ... 600Ω	0 ... 6000	nominal range
	---	---	underrange
3 wire: 0 ... 3000Ω (9Ah)	---	---	overrange
	0 ... 3000Ω	0 ... 30000	nominal range
	---	---	underrange
4 wire: 0 ... 60Ω (A0h)	---	---	overrange
	0 ... 60Ω	0 ... 6000	nominal range
	---	---	underrange
4 wire: 0 ... 600Ω (A1h)	---	---	overrange
	0 ... 600Ω	0 ... 6000	nominal range
	---	---	underrange
4 wire: 0 ... 3000Ω (A2h)	---	---	overrange
	0 ... 3000Ω	0 ... 30000	nominal range
	---	---	underrange
2 wire: 0 ... 60Ω (D0h)	70.55Ω	32511	overrange
	0 ... 60Ω	0 ... 27648	nominal range
	---	---	underrange
2 wire: 0 ... 600Ω (D1h)	705.5Ω	32511	overrange
	0 ... 600Ω	0 ... 27648	nominal range
	---	---	underrange
2 wire: 0 ... 3000Ω (D2h)	3528Ω	32511	overrange
	0 ... 3000Ω	0 ... 27648	nominal range
	---	---	underrange
3 wire: 0 ... 60Ω (D8h)	70.55Ω	32511	overrange
	0 ... 60Ω	0 ... 27648	nominal range
	---	---	underrange

031-1BD80 - AI 4x16Bit R/RTD &gt; Parameter data

Measuring range Resistance (funct. no.)	Measuring value	Signal range	Range
3 wire: 0 ... 600Ω (D9h)	705.5Ω	32511	overrange
	0 ... 600Ω	0 ... 27648	nominal range
	---	---	underrange
3 wire: 0 ... 3000Ω (DAh)	3528Ω	32511	overrange
	0 ... 3000Ω	0 ... 27648	nominal range
	---	---	underrange
4 wire: 0 ... 60Ω (E0h)	70.55Ω	32511	overrange
	0 ... 60Ω	0 ... 27648	nominal range
	---	---	underrange
4 wire: 0 ... 600Ω (E1h)	705.5Ω	32511	overrange
	0 ... 600Ω	0 ... 27648	nominal range
	---	---	underrange
4 wire: 0 ... 3000Ω (E2h)	3528Ω	32511	overrange
	0 ... 3000Ω	0 ... 27648	nominal range
	---	---	underrange

1) Supported by 031-1BD80 from version 03V54 and 031-1LD80 from version 02V26.

The version information can be found on the outer packaging or via the website of the corresponding head module.

**CHxFO Function option channel x**

Depending on the Interference frequency suppression for each channel the transducer velocity may be set.

Code	Velocity (in ms) / channel at Interference frequency suppression	
	50Hz	60Hz
00h <sup>1</sup>	324.1	270.5
01h <sup>1</sup>	164.2	137.2
02h <sup>1</sup>	84.2	70.5
03h	44.1	37.2
04h	24.2	20.5
05h	14.2	12.2
06h	9.2	8.0
07h	6.6	5.9
08h	4.2	3.8

1) For Code 00h, 01h and 02h the tolerances of the technical data "with interference frequency suppression" are valid.

**CHxUL / CHxLL channel x**For each channel an *upper* and a *lower limit* may be defined. Here only values of the nominal range may be preset, otherwise you receive a parameterization error. By presetting 7FFFh for the upper respectively 8000h for the lower limit value the corresponding limit is deactivated. As soon as the measuring value is beyond the limits and the limit value monitoring is activated, a hardware interrupt is initialized.

### 3.13.3 Diagnostics and interrupt

Event	Hardware interrupt	Diagnostics interrupt	parameterizable
Error in project engineering/parameterization	-	X	-
Wire break	-	X	X
Measuring range overflow	-	X	-
Measuring range underflow	-	X	-
Limit overflow	X	-	X
Limit underflow	X	-	X
Diagnostic buffer overflow	-	X	-
Communication error	-	X	-
Hardware interrupt lost	-	X	-

#### Hardware interrupt

So you may react to asynchronous events, there is the possibility to activate a hardware interrupt.

- A hardware interrupt interrupts the linear program sequence and jumps depending on the master system to a corresponding Interrupt routine. Here you can react to the hardware interrupt accordingly.
- With CANopen the hardware interrupt data is transferred via an emergency telegram.
- Operating with CPU, PROFIBUS and PROFINET the hardware interrupt data were transferred via diagnostics telegram.

SX Subindex for access via EtherCAT with Index 5000h

More can be found in the according manual of your bus coupler.

Name	Bytes	Function	Default	SX
PRIT_OL	1	Upper limit overflow channel x	00h	02h
PRIT_UL	1	Lower limit underflow channel x	00h	03h
PRIT_US	2	µs-Ticker	00h	04h (high byte) 05h (low byte)

#### PRIT\_OL Limit overflow

Byte	Bit 7 ... 0
0	<ul style="list-style-type: none"> <li>■ Bit 0: Limit overflow channel 0</li> <li>■ ...</li> <li>■ Bit 7: Limit overflow channel 3</li> <li>■ Bit 7 ... 4: reserved</li> </ul>

#### PRIT\_UL Limit underflow

Byte	Bit 7 ... 0
0	<ul style="list-style-type: none"> <li>■ Bit 0: Limit underflow channel 0</li> <li>■ ...</li> <li>■ Bit 3: Limit underflow channel 3</li> <li>■ Bit 7 ... 4: reserved</li> </ul>

**PRIT\_US  $\mu$ s ticker**

Byte	Bit 7 ... 0
0 ... 1	16bit $\mu$ s value at the moment of the interrupt

 *$\mu$ s ticker*

In the module there is a 32 bit timer ( $\mu$ s ticker). With PowerON the timer starts counting with 0. After  $2^{32}-1\mu$ s the timer starts with 0 again. PRIT\_US represents the lower 2 byte of the  $\mu$ s ticker value (0 ...  $2^{16}-1$ ).

**Diagnostic data**

Via the parametrization you may activate a diagnostic interrupt for the module. With a diagnostics interrupt the module serves for diagnostics data for diagnostic interrupt<sub>incoming</sub>. As soon as the reason for releasing a diagnostic interrupt is no longer present, the diagnostic interrupt<sub>going</sub> automatically takes place. All events of a channel between diagnostic interrupt<sub>incoming</sub> and diagnostic interrupt<sub>going</sub> are not stored and get lost. Within this time window (1. diagnostic interrupt<sub>incoming</sub> until last diagnostic interrupt<sub>going</sub>) the MF-LED of the module is on.

DS Record set for access via CPU, PROFIBUS and PROFINET. The access happens by DS 01h. Additionally the first 4 bytes may be accessed by DS 00h.

IX Index for access via CANopen. The access happens by IX 2F01h. Additionally the first 4 bytes may be accessed by IX 2F00h.

SX Subindex for access via EtherCAT with Index 5005h.

More can be found in the according manual of your bus coupler.

Name	Bytes	Function	Default	DS	IX	SX
ERR_A	1	Diagnostic	00h	01h	2F01h	02h
MODTYP	1	Module information	15h			03h
ERR_C	1	reserved	00h			04h
ERR_D	1	Diagnostic	00h			05h
CHTYP	1	Channel type	71h			06h
NUMBIT	1	Number diagnostic bits per channel	08h			07h
NUMCH	1	Number of channels of a module	04h			08h
CHERR	1	Channel error	00h			09h
CH0ERR	1	Channel-specific error channel 0	00h			0Ah
CH1ERR	1	Channel-specific error channel 1	00h			0Bh
CH2ERR	1	Channel-specific error channel 2	00h			0Ch
CH3ERR	1	Channel-specific error channel 3	00h			0Dh
CH4ERR... CH7ERR	4	reserved	00h			0Eh...11h
DIAG_US	4	$\mu$ s ticker	00h			13h



**ERR\_A Diagnostic**

Byte	Bit 7 ... 0
0	<ul style="list-style-type: none"> <li>■ Bit 0: set at module failure</li> <li>■ Bit 1: set at internal error</li> <li>■ Bit 2: set at external error</li> <li>■ Bit 3: set at channel error</li> <li>■ Bit 4: set at external auxiliary supply missing</li> <li>■ Bit 6 ... 5: reserved</li> <li>■ Bit 7: set at error in parametrization</li> </ul>

**MODTYP  
Module information**

Byte	Bit 7 ... 0
0	<ul style="list-style-type: none"> <li>■ Bit 3 ... 0: module class <ul style="list-style-type: none"> <li>- 0101b analog module</li> </ul> </li> <li>■ Bit 4: set at channel information present</li> <li>■ Bit 7 ... 5: reserved</li> </ul>

**ERR\_D Diagnostic**

Byte	Bit 7 ... 0
0	<ul style="list-style-type: none"> <li>■ Bit 2 ... 0: reserved</li> <li>■ Bit 3: set at internal diagnostics buffer overflow</li> <li>■ Bit 4: set at internal communication error</li> <li>■ Bit 5: reserved</li> <li>■ Bit 6: set at hardware interrupt lost</li> <li>■ Bit 7: reserved</li> </ul>

**CHTYP Channel type**

Byte	Bit 7 ... 0
0	<ul style="list-style-type: none"> <li>■ Bit 6 ... 0: Channel type <ul style="list-style-type: none"> <li>- 70h: Digital input</li> <li>- 71h: Analog input</li> <li>- 72h: Digital output</li> <li>- 73h: Analog output</li> <li>- 74h: Analog input/-output</li> <li>- 76h: Counter</li> </ul> </li> <li>■ Bit 7: reserved</li> </ul>

**NUMBIT Diagnostic bits**

Byte	Bit 7 ... 0
0	Number of diagnostic bits per channel (here 08h)

**NUMCH Channels**

Byte	Bit 7 ... 0
0	Number of channels of a module (here 04h)

**CHERR Channel error**

Byte	Bit 7 ... 0
0	<ul style="list-style-type: none"> <li>■ Bit 0: set at error in channel group 0</li> <li>■ Bit 1: set at error in channel group 1</li> <li>■ Bit 2: set at error in channel group 2</li> <li>■ Bit 3: set at error in channel group 3</li> <li>■ Bit 7 ... 4: reserved</li> </ul>

**CH0ERR/CH3ERR  
Channel-specific**

Byte	Bit 7 ... 0
0	Channel-specific error: channel x: <ul style="list-style-type: none"> <li>■ Bit 0: set at error in project engineering/parameterization</li> <li>■ Bit 3 ... 1: reserved</li> <li>■ Bit 4: set at wire break</li> <li>■ Bit 5: set at hardware interrupt lost</li> <li>■ Bit 6: set at measuring range underflow</li> <li>■ Bit 7: set at measuring range overflow</li> </ul>

**CH4ERR ... CH7ERR  
reserved**

Byte	Bit 7 ... 0
0	reserved

**DIAG\_US  $\mu$ s ticker**

Byte	Bit 7 ... 0
0...3	Value of the $\mu$ s ticker at the moment of the diagnostic

 *$\mu$ s ticker*

In the System SLIO module there is a timer ( $\mu$ s ticker). With PowerON the timer starts counting with 0. After  $2^{32}-1\mu$ s the timer starts with 0 again.

### 3.14 031-1BF60 - AI 8x12Bit 0(4)...20mA

**Properties**

The electronic module has 8 inputs with parameterizable functions. The channels of the module are isolated to the backplane bus.

- 8 analog single ended inputs (reference potential 0V)
- Suited for sensors with 0(4) ... 20mA with external supply
- Interference frequency suppression parameterizable (50/60Hz)
- Diagnostics function
- 12bit resolution

**Structure**

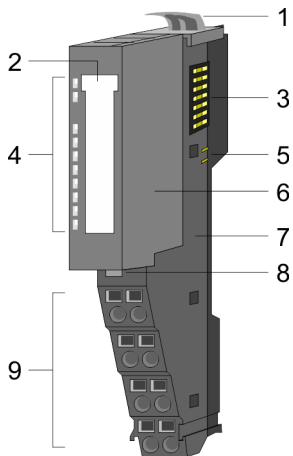

- 1 Locking lever terminal module
- 2 Labeling strip
- 3 Backplane bus
- 4 LED status indication
- 5 DC 24V power section supply
- 6 Electronic module
- 7 Terminal module
- 8 Locking lever electronic module
- 9 Terminal

**Status indication**

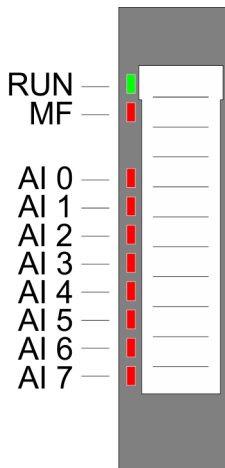

RUN	MF	AI x	Description
<input checked="" type="checkbox"/> green	<input checked="" type="checkbox"/> red	<input checked="" type="checkbox"/> red	
<input checked="" type="checkbox"/>	<input type="checkbox"/>	X	Bus communication is OK Module status is OK
<input checked="" type="checkbox"/>	<input checked="" type="checkbox"/>	X	Bus communication is OK Module status reports an error
<input type="checkbox"/>	<input checked="" type="checkbox"/>	X	Bus communication is not possible Module status reports an error
<input type="checkbox"/>	<input type="checkbox"/>	X	Error at bus power supply
X	<input checked="" type="checkbox"/>	X	Error in configuration → <a href="#">‘Trouble shooting - LEDs’...page 41</a>
<input checked="" type="checkbox"/>	<input type="checkbox"/>	<input checked="" type="checkbox"/>	Error channel x <ul style="list-style-type: none"> <li>■ Signal leaves measuring range</li> <li>■ Error in parameterization</li> </ul>
not relevant: X			

031-1BF60 - AI 8x12Bit 0(4)...20mA

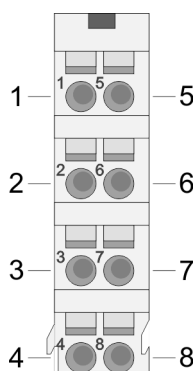
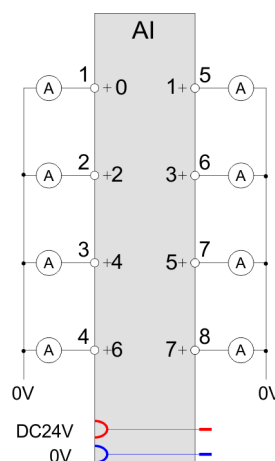
**Pin assignment**For wires with a cross section of 0.08mm<sup>2</sup> up to 1.5mm<sup>2</sup>.

Pos.	Function	Type	Description
1	+AI 0	I	+ Channel 0
2	+AI 2	I	+ Channel 2
3	+AI 4	I	+ Channel 4
4	+AI 6	I	+ Channel 6
5	+AI 1	I	+ Channel 1
6	+AI 3	I	+ Channel 3
7	+AI 5	I	+ Channel 5
8	+AI 7	I	+ Channel 7

I: Input

**In-/Output area**

At CPU, PROFIBUS and PROFINET the input respectively output area is embedded to the corresponding address area.

IX Index for access via CANopen with s = Subindex, depends on number and type of analog modules

SX Subindex for access via EtherCAT with Index 6000h + EtherCAT-Slot

More can be found in the according manual of your bus coupler.

**Input area**

Addr.	Name	Bytes	Function	IX	SX
+0	AI 0	2	Analog value channel 0	6401h/s	01h
+2	AI 1	2	Analog value channel 1	6401h/s+1	02h
+4	AI 2	2	Analog value channel 2	6401h/s+2	03h
+6	AI 3	2	Analog value channel 3	6401h/s+3	04h
+8	AI 4	2	Analog value channel 4	6401h/s+4	05h
+10	AI 5	2	Analog value channel 5	6401h/s+5	06h
+12	AI 6	2	Analog value channel 6	6401h/s+6	07h
+14	AI 7	2	Analog value channel 7	6401h/s+7	08h

**Output area**

No byte of the output area is used by the module.

## 3.14.1 Technical data

Order no.	031-1BF60
Type	SM 031 - Analog input
Module ID	0416 15C5
<b>Current consumption/power loss</b>	
Current consumption from backplane bus	70 mA
Power loss	1 W
<b>Technical data analog inputs</b>	
Number of inputs	8
Cable length, shielded	200 m
Rated load voltage	DC 24 V
Current consumption from load voltage L+ (without load)	20 mA
Voltage inputs	-
Min. input resistance (voltage range)	-
Input voltage ranges	-
Operational limit of voltage ranges	-
Operational limit of voltage ranges with SFU	-
Basic error limit voltage ranges	-
Basic error limit voltage ranges with SFU	-
Destruction limit voltage	-
Current inputs	✓
Max. input resistance (current range)	60 Ω
Input current ranges	0 mA ... +20 mA +4 mA ... +20 mA
Operational limit of current ranges	+/-1,1%
Operational limit of current ranges with SFU	-
Basic error limit current ranges	+/-1,0%
Radical error limit current ranges with SFU	-
Destruction limit current inputs (voltage)	max. 30V
Destruction limit current inputs (electrical current)	max. 40mA
Resistance inputs	-
Resistance ranges	-
Operational limit of resistor ranges	-
Operational limit of resistor ranges with SFU	-
Basic error limit	-
Basic error limit with SFU	-
Destruction limit resistance inputs	-
Resistance thermometer inputs	-
Resistance thermometer ranges	-

031-1BF60 - AI 8x12Bit 0(4)...20mA &gt; Technical data

Order no.	031-1BF60
Operational limit of resistance thermometer ranges	-
Operational limit of resistance thermometer ranges with SFU	-
Basic error limit thermoresistor ranges	-
Basic error limit thermoresistor ranges with SFU	-
Destruction limit resistance thermometer inputs	-
Thermocouple inputs	-
Thermocouple ranges	-
Operational limit of thermocouple ranges	-
Operational limit of thermocouple ranges with SFU	-
Basic error limit thermocouple ranges	-
Basic error limit thermocouple ranges with SFU	-
Destruction limit thermocouple inputs	-
Programmable temperature compensation	-
External temperature compensation	-
Internal temperature compensation	-
Temperature error internal compensation	-
Technical unit of temperature measurement	-
Resolution in bit	12
Measurement principle	successive approximation
Basic conversion time	1.1 ms all channels
Noise suppression for frequency	>50dB at 50Hz (UCM<2V)
<b>Status information, alarms, diagnostics</b>	
Status display	yes
Interrupts	no
Process alarm	no
Diagnostic interrupt	no
Diagnostic functions	yes
Diagnostics information read-out	possible
Module state	green LED
Module error display	red LED
Channel error display	red LED per channel
<b>Isolation</b>	
Between channels	-
Between channels of groups to	-
Between channels and backplane bus	✓
Between channels and power supply	-
Max. potential difference between circuits	-

Order no.	031-1BF60
Max. potential difference between inputs (Ucm)	-
Max. potential difference between Mana and Mintern (Uiso)	-
Max. potential difference between inputs and Mana (Ucm)	-
Max. potential difference between inputs and Mintern (Uiso)	DC 75 V/ AC 50 V
Max. potential difference between Mintern and outputs	-
Insulation tested with	DC 500 V
<b>Technical data encoder supply</b>	
Number of outputs	-
Output voltage (typ)	-
Output voltage (rated value)	-
Short-circuit protection	-
Binding of potential	-
<b>Datasizes</b>	
Input bytes	16
Output bytes	0
Parameter bytes	14
Diagnostic bytes	20
<b>Housing</b>	
Material	PPE / PPE GF10
Mounting	Profile rail 35 mm
<b>Mechanical data</b>	
Dimensions (WxHxD)	12.9 mm x 109 mm x 76.5 mm
Net weight	58 g
Weight including accessories	58 g
Gross weight	73 g
<b>Environmental conditions</b>	
Operating temperature	0 °C to 60 °C
Storage temperature	-25 °C to 70 °C
<b>Certifications</b>	
UL certification	yes
KC certification	yes
UKCA certification	yes
ChinaRoHS certification	yes

SFU

Interference frequency suppression

### 3.14.2 Parameter data

DS Record set for access via CPU, PROFIBUS and PROFINET

IX Index for access via CANopen

SX Subindex for access via EtherCAT with Index 3100h + EtherCAT-Slot

More can be found in the according manual of your bus coupler.

Name	Bytes	Function	Default	DS	IX	SX
SUPR	2	Interference frequency suppression (SFU)	0000h	01h	3100h, 3101h	01h
CH0FN	1	Function number channel 0	31h	80h	3102h	02h
CH1FN	1	Function number channel 1	31h	81h	3103h	03h
CH2FN	1	Function number channel 2	31h	82h	3104h	04h
CH3FN	1	Function number channel 3	31h	83h	3105h	05h
CH4FN	1	Function number channel 4	31h	84h	3106h	06h
CH5FN	1	Function number channel 5	31h	85h	3107h	07h
CH6FN	1	Function number channel 6	31h	86h	3108h	08h
CH7FN	1	Function number channel 7	31h	87h	3109h	09h

#### SUPR Interference frequency suppression (SFU)

Byte	Bit 15 ... 0
0	<ul style="list-style-type: none"> <li>■ Bit 0, 1: Interference frequency suppression channel 0</li> <li>■ Bit 2, 3: Interference frequency suppression channel 1</li> <li>■ Bit 4, 5: Interference frequency suppression channel 2</li> <li>■ Bit 6, 7: Interference frequency suppression channel 3</li> <li>■ Bit 8, 9: Interference frequency suppression channel 4</li> <li>■ Bit 10, 11: Interference frequency suppression channel 5</li> <li>■ Bit 12, 13: Interference frequency suppression channel 6</li> <li>■ Bit 14, 15: Interference frequency suppression channel 7               <ul style="list-style-type: none"> <li>- 00: deactivated</li> <li>- 01: 60Hz</li> <li>- 10: 50Hz</li> </ul> </li> </ul>

#### CHxFN Function number channel x

In the following there are the measuring ranges with corresponding function number listed, which were supported by the analog module. With FFh the corresponding channel is deactivated. The formulas listed here allow you to transform an evaluated measuring value (digital value) to a value assigned to the measuring range (analog value) and vice versa.



Meas. range Current 0(4) ... 20mA (funct. no.)	Current (I)	Decimal (D)	Hex	Range	Formulas
0 ... 20mA Siemens S7 format (31h)	23.52mA	32511	7EFFh	overrange	$D = 27648 \cdot \frac{I}{20}$ $I = D \cdot \frac{20}{27648}$
	20mA	27648	6C00h	nominal range	
	10mA	13824	3600h		
	0mA	0	0000h		
	-3.52mA	-4864	ED00h	underrange	
0 ... 20mA Siemens S5 format (41h)	25.00mA	20480	5000h	overrange	$D = 16384 \cdot \frac{I}{20}$ $I = D \cdot \frac{20}{16384}$
	20mA	16384	4000h	nominal range	
	10mA	8192	2000h		
	0mA	0	0000h		
	-4,00mA	-3277	F333h	underrange	
4 ... 20mA Siemens S7 format (30h)	22.81mA	32511	7EFFh	overrange	$D = 27648 \cdot \frac{I-4}{16}$ $I = D \cdot \frac{16}{27648} + 4$
	20mA	27648	6C00h	nominal range	
	12mA	13824	3600h		
	4mA	0	0000h		
	1.19mA	-4864	ED00h	underrange	
4 ... 20mA Siemens S5 format (40h)	24.00mA	20480	5000h	overrange	$D = 16384 \cdot \frac{I-4}{16}$ $I = D \cdot \frac{16}{16384} + 4$
	20mA	16384	4000h	nominal range	
	12mA	8192	2000h		
	4mA	0	0000h		
	0.8mA	-3277	F333h	underrange	

### 3.14.3 Diagnostic data

So this module does not support diagnostic interrupt functions, the diagnostics data serve for information about this module. On error the corresponding channel LED of the module is activated and the error is registered in the diagnostics data.

The following errors are listed in the diagnostics data:

- Error in project engineering / parameterization
- Measuring range overflow
- Measuring range underflow

DS Record set for access via CPU, PROFIBUS and PROFINET. The access happens by DS 01h. Additionally the first 4 bytes may be accessed by DS 00h.

IX Index for access via CANopen. The access happens by IX 2F01h. Additionally the first 4 bytes may be accessed by IX 2F00h.

SX Subindex for access via EtherCAT with Index 5005h.

More can be found in the according manual of your bus coupler.

031-1BF60 - AI 8x12Bit 0(4)...20mA &gt; Diagnostic data

Name	Bytes	Function	Default	DS	IX	SX
ERR_A	1	Diagnostic	00h	01h	2F01h	02h
MODTYP	1	Module information	15h			03h
ERR_C	1	reserved	00h			04h
ERR_D	1	Diagnostic	00h			05h
CHTYP	1	Channel type	71h			06h
NUMBIT	1	Number diagnostic bits per channel	08h			07h
NUMCH	1	Number of channels of a module	08h			08h
CHERR	1	Channel error	00h			09h
CH0ERR	1	Channel-specific error channel 0	00h			0Ah
CH1ERR	1	Channel-specific error channel 1	00h			0Bh
CH2ERR	1	Channel-specific error channel 2	00h			0Ch
CH3ERR	1	Channel-specific error channel 3	00h			0Dh
CH4ERR	1	Channel-specific error channel 4	00h			0Eh
CH5ERR	1	Channel-specific error channel 5	00h			0Fh
CH6ERR	1	Channel-specific error channel 6	00h			10h
CH7ERR	1	Channel-specific error channel 7	00h			11h
DIAG_US	4	µs ticker	00h			13h

**ERR\_A Diagnostic**

Byte	Bit 7 ... 0
0	<ul style="list-style-type: none"> <li>■ Bit 0: set at module failure</li> <li>■ Bit 1: set at internal error</li> <li>■ Bit 2: set at external error</li> <li>■ Bit 3: set at channel error</li> <li>■ Bit 4: set at external auxiliary supply missing</li> <li>■ Bit 6 ... 5: reserved</li> <li>■ Bit 7: set at error in parametrization</li> </ul>

**MODTYP  
Module information**

Byte	Bit 7 ... 0
0	<ul style="list-style-type: none"> <li>■ Bit 3 ... 0: module class <ul style="list-style-type: none"> <li>– 0101b analog module</li> </ul> </li> <li>■ Bit 4: set at channel information present</li> <li>■ Bit 7 ... 5: reserved</li> </ul>

**ERR\_D Diagnostic**

Byte	Bit 7 ... 0
0	<ul style="list-style-type: none"> <li>■ Bit 3 ... 0: reserved</li> <li>■ Bit 4: set at internal communication error</li> <li>■ Bit 7 ... 5: reserved</li> </ul>

**CHTYP Channel type**

Byte	Bit 7 ... 0
0	<ul style="list-style-type: none"> <li>■ Bit 6 ... 0: Channel type               <ul style="list-style-type: none"> <li>- 70h: Digital input</li> <li>- 71h: Analog input</li> <li>- 72h: Digital output</li> <li>- 73h: Analog output</li> <li>- 74h: Analog input/-output</li> <li>- 76h: Counter</li> </ul> </li> <li>■ Bit 7: reserved</li> </ul>

**NUMBIT Diagnostic bits**

Byte	Bit 7 ... 0
0	Number of diagnostic bits per channel (here 08h)

**NUMCH Channels**

Byte	Bit 7 ... 0
0	Number of channels of a module (here 08h)

**CHERR Channel error**

Byte	Bit 7 ... 0
0	<ul style="list-style-type: none"> <li>■ Bit 0: set at error in channel 0</li> <li>■ Bit 1: set at error in channel 1</li> <li>■ Bit 2: set at error in channel 2</li> <li>■ Bit 3: set at error in channel 3</li> <li>■ Bit 4: set at error in channel 4</li> <li>■ Bit 5: set at error in channel 5</li> <li>■ Bit 6: set at error in channel 6</li> <li>■ Bit 7: set at error in channel 7</li> </ul>

**CH0ERR ... CH7ERR  
Channel-specific**

Byte	Bit 7 ... 0
0	Channel-specific error channel x: <ul style="list-style-type: none"> <li>■ Bit 0: set at configuring-/parameter assignment error</li> <li>■ Bit 5 ... 1: reserved</li> <li>■ Bit 6: set at measuring range underflow</li> <li>■ Bit 7: set at measuring range overflow</li> </ul>

**DIAG\_US  $\mu$ s ticker**

Byte	Bit 7 ... 0
0...3	Value of the $\mu$ s ticker at the moment of the diagnostic

 *$\mu$ s ticker*

In the System SLIO module there is a timer ( $\mu$ s ticker). With PowerON the timer starts counting with 0. After  $2^{32}-1\mu$ s the timer starts with 0 again.

031-1BF74 - AI 8x12Bit ±10V

### 3.15 031-1BF74 - AI 8x12Bit ±10V

#### Properties

The electronic module has 8 inputs with parameterizable functions. The channels of the module are electrically isolated from the backplane bus.

- 8 analog single ended inputs (reference potential 0V)
- Suited for sensors with ±10V, 0 ... 10V with external supply
- Interference frequency suppression parameterizable (50/60Hz)
- Diagnostics function
- 12bit resolution

#### Structure

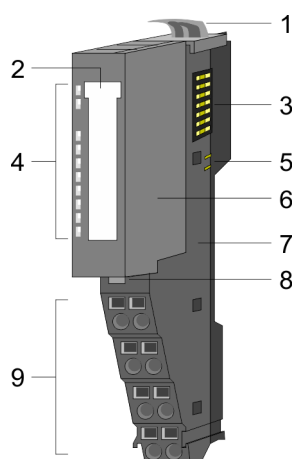

- 1 Locking lever terminal module
- 2 Labeling strip
- 3 Backplane bus
- 4 LED status indication
- 5 DC 24V power section supply
- 6 Electronic module
- 7 Terminal module
- 8 Locking lever electronic module
- 9 Terminal

#### Status indication

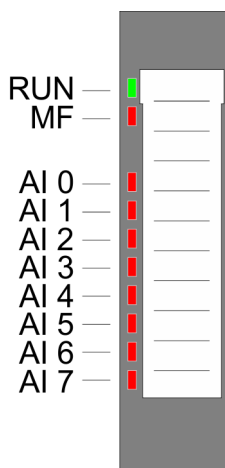

RUN	MF	AI x	Description
<input checked="" type="checkbox"/> green	<input checked="" type="checkbox"/> red	<input checked="" type="checkbox"/> red	
<input checked="" type="checkbox"/>	<input type="checkbox"/>	X	Bus communication is OK Module status is OK
<input checked="" type="checkbox"/>	<input checked="" type="checkbox"/>	X	Bus communication is OK Module status reports an error
<input type="checkbox"/>	<input checked="" type="checkbox"/>	X	Bus communication is not possible Module status reports an error
<input type="checkbox"/>	<input type="checkbox"/>	X	Error at bus power supply
X	<input checked="" type="checkbox"/>	X	Error in configuration → <a href="#">‘Trouble shooting - LEDs’...page 41</a>
<input checked="" type="checkbox"/>	<input type="checkbox"/>	<input checked="" type="checkbox"/>	Error channel x <ul style="list-style-type: none"> <li>■ Signal leaves measuring range</li> <li>■ Error in parameterization</li> </ul>
not relevant: X			

**Pin assignment**

For wires with a cross section of 0.08mm<sup>2</sup> up to 1.5mm<sup>2</sup>.

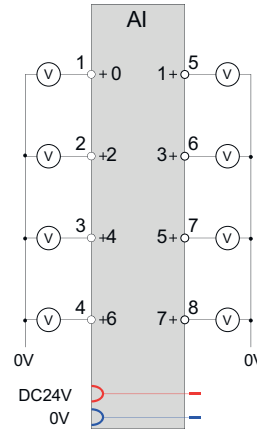
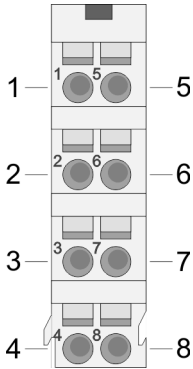

Pos.	Function	Type	Description
1	+AI 0	I	+ Channel 0
2	+AI 2	I	+ Channel 2
3	+AI 4	I	+ Channel 4
4	+AI 6	I	+ Channel 6
5	+AI 1	I	+ Channel 1
6	+AI 3	I	+ Channel 3
7	+AI 5	I	+ Channel 5
8	+AI 7	I	+ Channel 7

I: Input

**In-/Output area**

At CPU, PROFIBUS and PROFINET the input respectively output area is embedded to the corresponding address area.

IX Index for access via CANopen with s = Subindex, depends on number and type of analog modules

SX Subindex for access via EtherCAT with Index 6000h + EtherCAT-Slot

More can be found in the according manual of your bus coupler.

**Input area**

Addr.	Name	Bytes	Function	IX	SX
+0	AI 0	2	Analog value channel 0	6401h/s	01h
+2	AI 1	2	Analog value channel 1	6401h/s+1	02h
+4	AI 2	2	Analog value channel 2	6401h/s+2	03h
+6	AI 3	2	Analog value channel 3	6401h/s+3	04h
+8	AI 4	2	Analog value channel 4	6401h/s+4	05h
+10	AI 5	2	Analog value channel 5	6401h/s+5	06h
+12	AI 6	2	Analog value channel 6	6401h/s+6	07h
+14	AI 7	2	Analog value channel 7	6401h/s+7	08h

**Output area**

No byte of the output area is used by the module.

## 3.15.1 Technical data

Order no.	031-1BF74
Type	SM 031 - Analog input
Module ID	0415 15C5
<b>Current consumption/power loss</b>	
Current consumption from backplane bus	70 mA
Power loss	0.8 W
<b>Technical data analog inputs</b>	
Number of inputs	8
Cable length, shielded	200 m
Rated load voltage	DC 24 V
Current consumption from load voltage L+ (without load)	20 mA
Voltage inputs	✓
Min. input resistance (voltage range)	100 k $\Omega$
Input voltage ranges	0 V ... +10 V -10 V ... +10 V
Operational limit of voltage ranges	+/-1.1%
Operational limit of voltage ranges with SFU	-
Basic error limit voltage ranges	+/-1.0%
Basic error limit voltage ranges with SFU	-
Destruction limit voltage	max. 30V
Current inputs	-
Max. input resistance (current range)	-
Input current ranges	-
Operational limit of current ranges	-
Operational limit of current ranges with SFU	-
Basic error limit current ranges	-
Radical error limit current ranges with SFU	-
Destruction limit current inputs (voltage)	-
Destruction limit current inputs (electrical current)	-
Resistance inputs	-
Resistance ranges	-
Operational limit of resistor ranges	-
Operational limit of resistor ranges with SFU	-
Basic error limit	-
Basic error limit with SFU	-
Destruction limit resistance inputs	-
Resistance thermometer inputs	-
Resistance thermometer ranges	-

Order no.	031-1BF74
Operational limit of resistance thermometer ranges	-
Operational limit of resistance thermometer ranges with SFU	-
Basic error limit thermoresistor ranges	-
Basic error limit thermoresistor ranges with SFU	-
Destruction limit resistance thermometer inputs	-
Thermocouple inputs	-
Thermocouple ranges	-
Operational limit of thermocouple ranges	-
Operational limit of thermocouple ranges with SFU	-
Basic error limit thermocouple ranges	-
Basic error limit thermocouple ranges with SFU	-
Destruction limit thermocouple inputs	-
Programmable temperature compensation	-
External temperature compensation	-
Internal temperature compensation	-
Temperature error internal compensation	-
Technical unit of temperature measurement	-
Resolution in bit	12
Measurement principle	successive approximation
Basic conversion time	1.1 ms all channels
Noise suppression for frequency	>50dB at 50Hz (UCM<2V)
<b>Status information, alarms, diagnostics</b>	
Status display	yes
Interrupts	no
Process alarm	no
Diagnostic interrupt	no
Diagnostic functions	yes
Diagnostics information read-out	possible
Module state	green LED
Module error display	red LED
Channel error display	red LED per channel
<b>Isolation</b>	
Between channels	-
Between channels of groups to	-
Between channels and backplane bus	✓
Between channels and power supply	-
Max. potential difference between circuits	-

031-1BF74 - AI 8x12Bit  $\pm 10V$  > Technical data

Order no.	031-1BF74
Max. potential difference between inputs (Ucm)	-
Max. potential difference between Mana and Mintern (Uiso)	-
Max. potential difference between inputs and Mana (Ucm)	-
Max. potential difference between inputs and Mintern (Uiso)	DC 75 V/ AC 50 V
Max. potential difference between Mintern and outputs	-
Insulation tested with	DC 500 V
<b>Technical data encoder supply</b>	
Number of outputs	-
Output voltage (typ)	-
Output voltage (rated value)	-
Short-circuit protection	-
Binding of potential	-
<b>Datasizes</b>	
Input bytes	16
Output bytes	0
Parameter bytes	14
Diagnostic bytes	20
<b>Housing</b>	
Material	PPE / PPE GF10
Mounting	Profile rail 35 mm
<b>Mechanical data</b>	
Dimensions (WxHxD)	12.9 mm x 109 mm x 76.5 mm
Net weight	57 g
Weight including accessories	57 g
Gross weight	72 g
<b>Environmental conditions</b>	
Operating temperature	0 °C to 60 °C
Storage temperature	-25 °C to 70 °C
<b>Certifications</b>	
UL certification	yes
KC certification	yes
UKCA certification	yes
ChinaRoHS certification	yes

SFU

Interference frequency suppression



### 3.15.2 Parameter data

DS Record set for access via CPU, PROFIBUS and PROFINET

IX Index for access via CANopen

SX Subindex for access via EtherCAT with Index 3100h + EtherCAT-Slot

More can be found in the according manual of your bus coupler.

Name	Bytes	Function	Default	DS	IX	SX
SUPR	2	Interference frequency suppression (SFU)	0000h	01h	3100h, 3101h	01h
CH0FN	1	Function number channel 0	12h	80h	3102h	02h
CH1FN	1	Function number channel 1	12h	81h	3103h	03h
CH2FN	1	Function number channel 2	12h	82h	3104h	04h
CH3FN	1	Function number channel 3	12h	83h	3105h	05h
CH4FN	1	Function number channel 4	12h	84h	3106h	06h
CH5FN	1	Function number channel 5	12h	85h	3107h	07h
CH6FN	1	Function number channel 6	12h	86h	3108h	08h
CH7FN	1	Function number channel 7	12h	87h	3109h	09h

#### SUPR Interference frequency suppression (SFU)

Byte	Bit 15 ... 0
0	<ul style="list-style-type: none"> <li>■ Bit 0, 1: Interference frequency suppression channel 0</li> <li>■ Bit 2, 3: Interference frequency suppression channel 1</li> <li>■ Bit 4, 5: Interference frequency suppression channel 2</li> <li>■ Bit 6, 7: Interference frequency suppression channel 3</li> <li>■ Bit 8, 9: Interference frequency suppression channel 4</li> <li>■ Bit 10, 11: Interference frequency suppression channel 5</li> <li>■ Bit 12, 13: Interference frequency suppression channel 6</li> <li>■ Bit 14, 15: Interference frequency suppression channel 7               <ul style="list-style-type: none"> <li>- 00: deactivated</li> <li>- 01: 60Hz</li> <li>- 10: 50Hz</li> </ul> </li> </ul>

#### CHxFN Function number channel x

In the following there are the measuring ranges with corresponding function number listed, which were supported by the analog module. With FFh the corresponding channel is deactivated. The formulas listed here allow you to transform an evaluated measuring value (digital value) to a value assigned to the measuring range (analog value) and vice versa.

031-1BF74 - AI 8x12Bit ±10V &gt; Parameter data

Meas. range Voltage ±10V (funct. no.)	Voltage (U)	Decimal (D)	Hex	Range	Formulas
±10V Siemens S7 format (12h)	11.76V	32511	7EFFh	overrange	$D = 27648 \cdot \frac{U}{10}$ $U = D \cdot \frac{10}{27648}$
	10V	27648	6C00h	nominal range	
	5V	13824	3600h		
	0V	0	0000h		
	-5V	-13824	CA00h		
	-10V	-27648	9400h		
	-11.76V	-32512	8100h	underrange	
±10V Siemens S5 format (22h)	12.5V	20480	5000h	overrange	$D = 16384 \cdot \frac{U}{10}$ $U = D \cdot \frac{10}{16384}$
	10V	16384	4000h	nominal range	
	5V	8192	2000h		
	0V	0	0000h		
	-5V	-8192	E000h		
	-10V	-16384	C000h		
	-12.5V	-20480	B000h	underrange	

Meas. range Voltage 0 ... 10V (funct. no.)	Voltage (U)	Decimal (D)	Hex	Range	Formulas
0 ... 10V Siemens S7 format (10h)	11.76V	32511	7EFFh	overrange	$D = 27648 \cdot \frac{U}{10}$ $U = D \cdot \frac{10}{27648}$
	10V	27648	6C00h	nominal range	
	5V	13824	3600h		
	0V	0	0000h		
	-1.76V	-4864	ED00h	underrange	
0 ... 10V Siemens S5 format (20h)	12.5V	20480	5000h	overrange	$D = 16384 \cdot \frac{U}{10}$ $U = D \cdot \frac{10}{16384}$
	10V	16384	4000h	nominal range	
	5V	8192	2000h		
	0V	0	0000h		
	-2V	-3277	F333h	underrange	

### 3.15.3 Diagnostic data

So this module does not support diagnostic interrupt functions, the diagnostics data serve for information about this module. On error the corresponding channel LED of the module is activated and the error is registered in the diagnostics data.

The following errors are listed in the diagnostics data:

- Error in project engineering / parameterization
- Measuring range overflow
- Measuring range underflow

DS Record set for access via CPU, PROFIBUS and PROFINET. The access happens by DS 01h. Additionally the first 4 bytes may be accessed by DS 00h.

IX Index for access via CANopen. The access happens by IX 2F01h. Additionally the first 4 bytes may be accessed by IX 2F00h.

SX Subindex for access via EtherCAT with Index 5005h.

More can be found in the according manual of your bus coupler.

Name	Bytes	Function	Default	DS	IX	SX
ERR_A	1	Diagnostic	00h	01h	2F01h	02h
MODTYP	1	Module information	15h			03h
ERR_C	1	reserved	00h			04h
ERR_D	1	Diagnostic	00h			05h
CHTYP	1	Channel type	71h			06h
NUMBIT	1	Number diagnostic bits per channel	08h			07h
NUMCH	1	Number of channels of a module	08h			08h
CHERR	1	Channel error	00h			09h
CH0ERR	1	Channel-specific error channel 0	00h			0Ah
CH1ERR	1	Channel-specific error channel 1	00h			0Bh
CH2ERR	1	Channel-specific error channel 2	00h			0Ch
CH3ERR	1	Channel-specific error channel 3	00h			0Dh
CH4ERR	1	Channel-specific error channel 4	00h			0Eh
CH5ERR	1	Channel-specific error channel 5	00h			0Fh
CH6ERR	1	Channel-specific error channel 6	00h			10h
CH7ERR	1	Channel-specific error channel 7	00h			11h
DIAG_US	4	µs ticker	00h			13h

031-1BF74 - AI 8x12Bit  $\pm 10V$  > Diagnostic data**ERR\_A Diagnostic**

Byte	Bit 7 ... 0
0	<ul style="list-style-type: none"> <li>■ Bit 0: set at module failure</li> <li>■ Bit 1: set at internal error</li> <li>■ Bit 2: set at external error</li> <li>■ Bit 3: set at channel error</li> <li>■ Bit 4: set at external auxiliary supply missing</li> <li>■ Bit 6 ... 5: reserved</li> <li>■ Bit 7: set at error in parametrization</li> </ul>

**MODTYP**  
**Module information**

Byte	Bit 7 ... 0
0	<ul style="list-style-type: none"> <li>■ Bit 3 ... 0: module class <ul style="list-style-type: none"> <li>- 0101b analog module</li> </ul> </li> <li>■ Bit 4: set at channel information present</li> <li>■ Bit 7 ... 5: reserved</li> </ul>

**ERR\_D Diagnostic**

Byte	Bit 7 ... 0
0	<ul style="list-style-type: none"> <li>■ Bit 3 ... 0: reserved</li> <li>■ Bit 4: set at internal communication error</li> <li>■ Bit 7 ... 5: reserved</li> </ul>

**CHTYP Channel type**

Byte	Bit 7 ... 0
0	<ul style="list-style-type: none"> <li>■ Bit 6 ... 0: Channel type <ul style="list-style-type: none"> <li>- 70h: Digital input</li> <li>- 71h: Analog input</li> <li>- 72h: Digital output</li> <li>- 73h: Analog output</li> <li>- 74h: Analog input/-output</li> <li>- 76h: Counter</li> </ul> </li> <li>■ Bit 7: reserved</li> </ul>

**NUMBIT Diagnostic bits**

Byte	Bit 7 ... 0
0	Number of diagnostic bits per channel (here 08h)

**NUMCH Channels**

Byte	Bit 7 ... 0
0	Number of channels of a module (here 08h)

**CHERR Channel error**

Byte	Bit 7 ... 0
0	<ul style="list-style-type: none"> <li>■ Bit 0: set at error in channel 0</li> <li>■ Bit 1: set at error in channel 1</li> <li>■ Bit 2: set at error in channel 2</li> <li>■ Bit 3: set at error in channel 3</li> <li>■ Bit 4: set at error in channel 4</li> <li>■ Bit 5: set at error in channel 5</li> <li>■ Bit 6: set at error in channel 6</li> <li>■ Bit 7: set at error in channel 7</li> </ul>

**CH0ERR ... CH7ERR  
Channel-specific**

Byte	Bit 7 ... 0
0	Channel-specific error channel x: <ul style="list-style-type: none"> <li>■ Bit 0: set at configuring-/parameter assignment error</li> <li>■ Bit 5 ... 1: reserved</li> <li>■ Bit 6: set at measuring range underflow</li> <li>■ Bit 7: set at measuring range overflow</li> </ul>

**DIAG\_US  $\mu s$  ticker**

Byte	Bit 7 ... 0
0...3	Value of the $\mu s$ ticker at the moment of the diagnostic

 *$\mu s$  ticker*

In the System SLIO module there is a timer ( $\mu s$  ticker). With PowerON the timer starts counting with 0. After  $2^{32}-1\mu s$  the timer starts with 0 again.

### 3.16 031-1CA20 - AI 1x16(24)Bit Strain gauge (DMS)

**Properties**

The electronic module has one channel and is suited to connect it to a strain gauge DMS sensor in load cells, force transducer and torque measuring shaft. The module has a configurable input filter and supports diagnostic interrupt.

- 1-channel for connecting a full bridge
- Absolute accuracy (basic error  $\pm 0.1\%$ )
- Manual calibration (zero and load adjustment)
- Configurable self-calibration (offset and gain error)
- Fast measurement by high signal bandwidth (ADC with 4 kHz limit frequency)
- Parametrizable IIR filter (300 $\mu$ s - 3.6s or dynamic)
- Parametrizable 50/60 Hz rejection
- Programmable power supply for the load cell(s) / full bridge(s)
- Parallel operation of load cells possible
- Diagnostic function
- 16bit resolution (24bit internal)

**Structure**

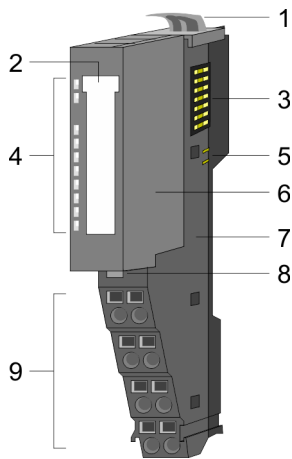

- 1 Locking lever terminal module
- 2 Labeling strip
- 3 Backplane bus
- 4 LED status indication
- 5 DC 24V power section supply
- 6 Electronic module
- 7 Terminal module
- 8 Locking lever electronic module
- 9 Terminal

**Status indication**

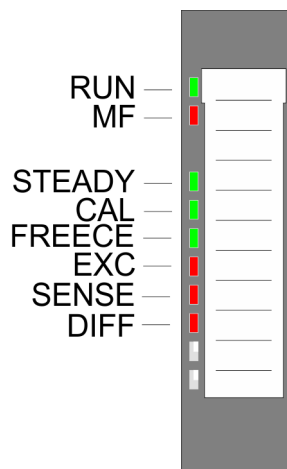

RUN	MF	Description
<input checked="" type="checkbox"/> green	<input checked="" type="checkbox"/> red	
<input checked="" type="checkbox"/>	<input type="checkbox"/>	Bus communication is OK Module status is OK
<input checked="" type="checkbox"/>	<input checked="" type="checkbox"/>	Bus communication is OK Module status reports an error
<input type="checkbox"/>	<input checked="" type="checkbox"/>	Bus communication is not possible Module status reports an error
<input type="checkbox"/>	<input type="checkbox"/>	Error at bus power supply
X	<input checked="" type="checkbox"/>	Error in configuration <a href="#">↪ 'Trouble shooting - LEDs'...page 41</a>
not relevant: X		

STEADY ■ green	CAL ■ green	FREEZE ■ green	EXC ■ red	SENSE ■ red	DIFF ■ red	Description
■	X	X	X	X	X	On in <i>Steady State</i> .
X	■	X	X	X	X	On at active self-calibration
X	X	■	X	X	X	On at activated <i>Input-Freeze</i> .
X	X	X	■	X	X	On at short circuit respectively over-load of the excitation voltage.
X	X	X	X	■	X	On at overrange of the excitation voltage
X	X	X	X	X	■	On at overrange of the differential voltage
not relevant: X						

Pin assignment

For wires with a core cross-section of 0.08mm<sup>2</sup> up to 1.5mm<sup>2</sup>.

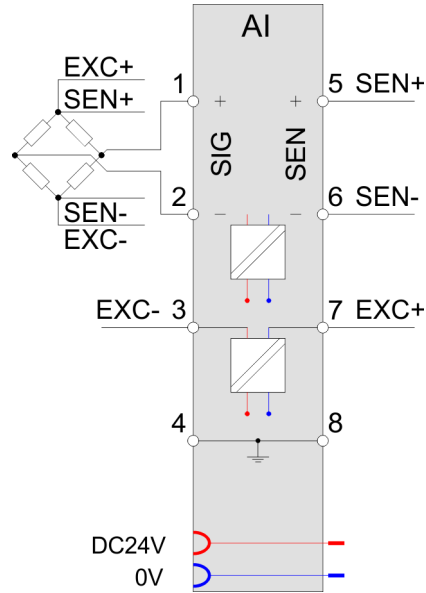
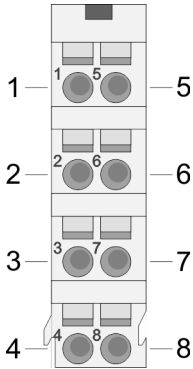

Pos.	Function	Type	Description
1	SIG+	I	+ Signal of the differential voltage $U_{SIG}$ of the measuring bridge
2	SIG-	I	- Signal of the differential voltage $U_{SIG}$ of the measuring bridge
3	EXC-	O	- Signal of the excitation voltage $U_{EXC}$
4	Shield	---	Connection for cable shield
5	SEN+	I	+ Sensor of the excitation voltage $U_{SEN}$
6	SEN-	I	- Sensor of the excitation voltage $U_{SEN}$
7	EXC+	O	+ Signal of the excitation voltage $U_{EXC}$
8	Shield	---	Connection for cable shield

O: Output, I: Input



Please always use the excitation voltage  $U_{EXC}$  of the module! The connection of sensors with external power supply is not possible.

### 3.16.1 Connection variants

#### 6 wire measurement

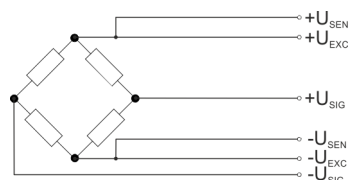

The following table shows the properties of the sensors, which can be used with the 6 wire measurement.

#### Sensor properties

Excitation voltage $U_{EXC}$	Bridge resistance $R_B$			
	120 $\Omega$	350 $\Omega$	700 $\Omega$	1000 $\Omega$
2.5V	X	X	X	X
5V	X	X	X	X
7.5V	X	X	X	X
10V	X	X	X	X
12V	X	X	X	X

#### 4 wire measurement

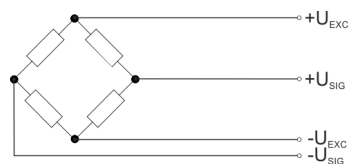

With the 4 wire measurement the  $U_{SEN}$  pins are not connected. With this operating mode there is an internal connection between  $U_{EXC}$  and  $U_{SEN}$ .

The following table shows the properties of the sensors, which can be used with the 4 wire measurement.

#### Sensor properties

Excitation voltage $U_{EXC}$	Bridge resistance $R_B$			
	120 $\Omega$	350 $\Omega$	700 $\Omega$	1000 $\Omega$
2.5V	X	X	X	X
5V	X	X	X	X
7.5V	X	X	X	X
10V	X	X	X	X
12V	X	X	X	X



**Parallel connection**

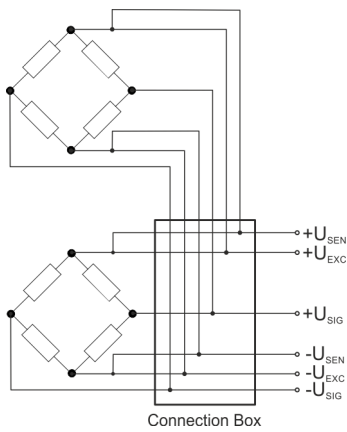

$$I_{EXC} = \frac{U_{EXC}}{\frac{R_B}{n}}$$

Normally large mechanical loads are divided to multiple strain gauge DMS load cells and these parallel connected via a connection box to the strain gauge DMS module. Please consider that the load cells are aligned together for this operating mode and approved by the manufacturer. And the current feed capacity of the transducer electronic should not be overloaded. The current feed capacity is derived from the number of parallel-connected load cells, excitation voltage  $U_{EXC}$  and the bridge resistance.

Depending on the excitation voltage  $U_{EXC}$ ,  $I_{EXC}$  may not exceed a maximum current:

- 2.5V: maximum current 120mA
- 5V: maximum current 120mA
- 7.5V: maximum current 100mA
- 10V: maximum current 90mA
- 12V: maximum current 80mA

For the calculation of  $I_{EXC}$  the following formula is used:

- $I_{EXC}$  Supply current
- $U_{EXC}$  Excitation voltage
- $R_B$  Bridge resistance
- $n$  Number of parallel connections

The following tables show the properties of the sensors for e.g. 2 respectively 3 parallel connected load cells.

**Example**

2 parallel	Bridge resistance $R_B$			
Excitation voltage $U_{Exc}$	60Ω	175Ω	350Ω	500Ω
2.5V	X	X	X	X
5V	X	X	X	X
7.5V	not possible	X	X	X
10V	not possible	X	X	X
12V	not possible	X	X	X

3 parallel	Bridge resistance $R_B$			
Excitation voltage $U_{Exc}$	40Ω	116.7Ω	233.3Ω	333.3Ω
2.5V	X	X	X	X
5V	not possible	X	X	X
7.5V	not possible	X	X	X
10V	not possible	X	X	X
12V	not possible	not possible	X	X



*To connect your sensors please always use shielded cables!  
Please always use the excitation voltage  $U_{EXC}$  of the module! The connection of sensors with external power supply is not possible.*

### 3.16.2 In-/Output area

#### In-/Output area

At CPU, PROFIBUS and PROFINET the input respectively output area is embedded to the corresponding address area.

IX Index for access via CANopen with s = Subindex, depends on number and type of analog modules

SX Subindex for access via EtherCAT with Index 6000h/7000h + EtherCAT-Slot

More can be found in the according manual of your bus coupler.

#### Input area

Addr.	Name	Bytes	Function	IX	SX
+0	DMS_VAL	4	Measured value	5470h/s	01h
+3	DMS_STAT	1	Status	5471h/s	02h

#### DMS\_VAL measured value (weight value)

	Byte 0								Byte 1							
Bit number	31	30	29	28	27	26	25	24	23	22	21	20	19	18	17	16
Significance	SG	2 <sup>30</sup>	2 <sup>29</sup>	2 <sup>28</sup>	2 <sup>27</sup>	2 <sup>26</sup>	2 <sup>25</sup>	2 <sup>24</sup>	2 <sup>23</sup>	2 <sup>22</sup>	2 <sup>21</sup>	2 <sup>20</sup>	2 <sup>19</sup>	2 <sup>18</sup>	2 <sup>17</sup>	2 <sup>16</sup>
31Bit+SG	SG	Measured value ...														

	Byte 2								Byte 3							
Bit number	15	14	13	12	11	10	9	8	7	6	5	4	3	2	1	0
Significance	2 <sup>15</sup>	2 <sup>14</sup>	2 <sup>13</sup>	2 <sup>12</sup>	2 <sup>11</sup>	2 <sup>10</sup>	2 <sup>9</sup>	2 <sup>8</sup>	2 <sup>7</sup>	2 <sup>6</sup>	2 <sup>5</sup>	2 <sup>4</sup>	2 <sup>3</sup>	2 <sup>2</sup>	2 <sup>1</sup>	2 <sup>0</sup>
31Bit+SG	... Measured value															

#### DMS\_STAT Status

Addr.	Name	Bytes	Function
+3	DMS_STAT	1	<ul style="list-style-type: none"> <li>■ Status byte               <ul style="list-style-type: none"> <li>– Bit 0: 1 = <i>Input Freeze</i> active</li> <li>– Bit 1: 1 = <i>Steady State</i> active<sup>1</sup></li> <li>– Bit 2: 1 = Self-calibration is running<sup>1</sup></li> <li>– Bit 3: 1 = Tara was changed</li> <li>– Bit 4: 1 = Error in adjustment</li> <li>– Bit 5: 1 = Adjustment was changed</li> <li>– Bit 6: reserved</li> <li>– Bit 7: 1 = Zero balance respectively reference point set</li> </ul> </li> </ul>

1) These status bits are set by internal event of the module.

- Input Freeze
  - In the activated state no measurement values are passed to the digital filter.
  - As long as the command bit is set, this bit remains set.
- Steady State
  - As soon as a measured value is longer than the time SSW within the tolerance window SST, in the status word the *Steady State* bit is set.
  - As soon as this condition is not true, the last measured value is first used, the comparison timer restarted and the bit is reset.
  - The values SSW and SST can be specified by the parametrization. → ['Parameter data'...page 196](#)

- Self calibration
  - As long as the self calibration is active, this bit is set.
  - During the self calibration there are two reference values internally measured and based on this the internal offset & factor are calculated.
  - With the self calibration the internal offset and gain error may be compensated.
  - The calibration interval *CI* can be preset by the parametrization.
- Tara
  - When setting or clearing the tare value, this bit is set.
  - As long as the corresponding command bit is set, this bit remains set.
- Adjustment
  - When you save or delete the adjustment data, this bit is set.
  - As long as the corresponding command bit is set, this bit remains set.
- Zero balance respectively reference point
  - When setting the zero balance respectively reference point this bit is set.
  - As long as the corresponding command bit is set, this bit remains set.

## Output area

Addr.	Name	Bytes	Function	IX	SX
+0	DMS_CMD	1	Command byte	5670h/s	01h

## DMS\_CMD

Addr.	Name	Bytes	Function
+0	DMS_CMD	1	<ul style="list-style-type: none"> <li>■ Command byte Each set bit in DMS_CMD is acknowledged by a bit in DMS_STAT.               <ul style="list-style-type: none"> <li>- Bit 0: Activate <i>Input Freeze</i> → DMS_STAT bit 0: active</li> <li>- Bit 1: Store adjustment → DMS_STAT bit 5: active</li> <li>- Bit 2: Delete adjustment → DMS_STAT bit 5: active</li> <li>- Bit 3: Set <i>Tara</i> → DMS_STAT bit 3: active</li> <li>- Bit 4: Delete <i>Tara</i> → DMS_STAT bit 3: active</li> <li>- Bit 5: reserved</li> <li>- Bit 6: Set zero point → DMS_STAT bit 7: active</li> <li>- Bit 7: Set reference point → DMS_STAT bit 7: active</li> </ul> </li> </ul>

- Input Freeze
  - In the activated state no measurement values are passed to the digital filter.
  - By a brief activation of *Input Freeze* pulses, e.g. caused by a filling procedure can be prevented, which would override the filter unnecessarily.
  - The status of *Input Freeze* can be determined at any time via bit 0 of DMS\_STAT.
- Adjustment
  - Store adjustment: Used to store the adjustment data when loaded with the reference weight.
  - Delete adjustment: Used to delete the adjustment data.
  - With both commands bit 5 of DMS\_STAT is set. In case of error bit 4 is set.
- Tara
  - Set Tara: The current value is taken as tara.
  - Delete Tara: Tara is reset to 0.
  - With both commands bit 3 of DMS\_STAT is set.

- Zero balance respectively reference point
  - Both commands are used for user adjustment and on both commands bit 7 of DMS\_STAT is set.
  - Set zero balance: Used to set the balance to 0 when operated without load.
  - Set reference point: Used to adjust the balance when it is loaded with a reference weight.

### 3.16.3 Technical data

Order no.	031-1CA20
Type	SM 031 - Analog input
Module ID	0841 1809
<b>Current consumption/power loss</b>	
Current consumption from backplane bus	55 mA
Power loss	1 W
<b>Technical data strain gauge DMS inputs</b>	
Number of inputs	1
Cable length, shielded	200 m
Rated load voltage	DC 24 V
Reverse polarity protection of rated load voltage	✓
Current consumption from load voltage L+ (without load)	18 mA
Relative accuracy according to self-calibration	+/-0.01%
Operational limit Usense	+/-0.2%
Operational limit Usig	+/-0.2%
Basic error limit Usense	+/-0.1%
Basic error limit Usig	+/-0.1%
Destruction limit voltage	max. 12V
External bridge supply possible	-
Internal bridge supply possible	✓
Configurable bridge supply	2.5V / max. 120mA 5V / max. 120mA 7.5V / max. 100mA 10V / max. 90mA 12V / max. 80mA
Resolution in bit	24
Measurement principle	successive approximation
Basic conversion time	1ms cycle, 10ms...330ms depending on the filter
Input filter Hardware	Low pass 10kHz 3rd order
Input filter software	Dynamic IIR filter configurable IIR filter 0.1Hz...1000Hz configurable FIR filter 50Hz/60Hz

Order no.	031-1CA20
Initial data size	4 Byte
<b>Data for selection of the strain gauge DMS sensor</b>	
Bridge supply voltage EXC	0...12V
Bridge differential voltage SIG	+/-29mV
Rated output	0.5...4mV/V
4 wire connection possible	✓
6 wire connection possible	✓
Possible bridge configuration	symmetric full bridge
<b>Status information, alarms, diagnostics</b>	
Status display	yes
Interrupts	yes, parameterizable
Process alarm	no
Diagnostic interrupt	yes, parameterizable
Diagnostic functions	yes
Diagnostics information read-out	possible
Module state	yes
Module error display	red LED
Channel error display	red LED
<b>Isolation</b>	
Between channels	-
Between channels of groups to	-
Between channels and backplane bus	✓
Between channels and power supply	-
Max. potential difference between circuits	-
Max. potential difference between inputs (Ucm)	-
Max. potential difference between Mana and Mintern (Uiso)	-
Max. potential difference between inputs and Mana (Ucm)	-
Max. potential difference between inputs and Mintern (Uiso)	DC 75 V/ AC 50 V
Max. potential difference between Mintern and outputs	-
Insulation tested with	DC 500 V
<b>Datasizes</b>	
Input bytes	5
Output bytes	1
Parameter bytes	30
Diagnostic bytes	20
<b>Housing</b>	

<b>Order no.</b>	<b>031-1CA20</b>
Material	PC / PPE GF10
Mounting	Profile rail 35 mm
<b>Mechanical data</b>	
Dimensions (WxHxD)	12.9 mm x 109 mm x 76.5 mm
Net weight	64 g
Weight including accessories	64 g
Gross weight	78 g
<b>Environmental conditions</b>	
Operating temperature	0 °C to 60 °C
Storage temperature	-25 °C to 70 °C
<b>Certifications</b>	
UL certification	yes
KC certification	yes
UKCA certification	yes
ChinaRoHS certification	yes

### 3.16.4 Functionality

#### 3.16.4.1 Basics - Strain gauge DMS

##### Strain gauge DMS

Strain gauge DMS are fixed directly on a body or part of a sensor and serve for the following possibilities:

- Measurement of strains, compressions or torsions
- Measurement of forces and movements

There are the following strain gauge DMS types:

- electrical strain gauge DMS
  - An *electrical strain gauge DMS* consists of a carrier material (e.g. stretchable plastic film) with applied metal film. From this a grid of electrically conductive resistive material is created. During the measurement the behavior is used, that e.g. at the elongation of a metallic conductor resistance its length increases and its diameter decreases. Here the electrical resistance increases proportionally.
- optical strain gauge DMS
  - An *optical strain gauge DMS* consists of a fibre used as a sensor, with a laser-applied grid in the fibre. During the measurement the behavior is used, that with mechanical load the optical properties of the sensor are changed. Light is passed with a certain wavelength into the sensor. Depending on the deformation of the laser-applied grid of the sensor, a part of the light is reflected and evaluated with a suitable sensor (interrogator).

##### Characteristics of an strain gauge DMS

- Nominal load
  - Maximum permissible load for normal operation.
  - The *nominal load* is preset unit-free.

- Rated output

- The rated output is a measure of the sensitivity of the resistance bridge in dependence of the used excitation voltage.
- A typical value for a full bridge is 2mV/V, this means at nominal load with an excitation voltage of 12V the bridge differential voltage is ±24mV.
- The common area is 0.5...4mV/V, depending on the bridge and sensor type.

### 3.16.4.2 Function

#### Measurement

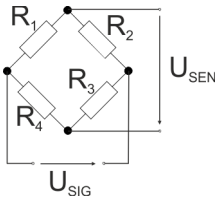

To get a weight value a power supply is applied to the bridge circuit and a differential voltage ( $U_{SIG}$ ) and excitation voltage ( $U_{SEN}$ ) are measured. The principle of measurement is based on that the differential voltage  $U_{SIG}$  of the bridge changes with a deformation. Thus, a relative weight value is calculated by the difference of the both voltages  $U_{SIG}$  and  $U_{SEN}$ , which are measured at the same time. The resulting difference is converted to a weight value and stored as process data in the input area.

#### Weight value determination

With the exception of *differential* and *excitation voltage* the remaining values are to be preset by the parametrization. The resulting weight value  $Y$  is determined within the module via the following formulas:

$$Y_R = \frac{U_{SIG}}{U_{SEN} \cdot RO}$$

$Y_R$  Relative value

$U_{SIG}$  Measured differential voltage of the measuring bridge

$U_{SEN}$  Measured excitation voltage

$RO$  Rated output

$$Y_A = Y_R \cdot NL \cdot SF$$

$Y_A$  Absolute value

$Y_R$  Relative value

$NL$  Nominal load

$SF$  Scale factor

$$Y = Y_A \cdot GN + TA$$

$Y$  Resulting weight value

$Y_A$  Absolute value

$GN$  Gain

$TA$  Tara

### 3.16.5 Parameter data

- DS Record set for access via CPU, PROFIBUS and PROFINET  
 IX Index for access via CANopen  
 SX Subindex for access via EtherCAT with Index 3100h + EtherCAT-Slot  
 More can be found in the according manual of your bus coupler.

#### Parameters

Due to the extensive parameter data you can use up to 8 of these modules with a PROFIBUS slave system.

Name	Bytes	Function	Default	DS	IX	SX
DIAG_EN	1	Diagnostic interrupt <sup>1</sup>	00h	00h	3100h	01h
UEXC	1	Excitation voltage <sup>1</sup>	00h	01h	3101h	02h
CAL	2	Calibration interval <sup>1</sup>	0000h	01h	3102h	03h
MEAS	1	Measurement method	23h	80h	3104h	04h
FILT	1	Filter selection	00h	80h	3105h	05h
DFCT	2	Dynamic filter change time	10h	80h	3106h	06h
DFD	2	Dynamic filter delta	20h	80h	3108h	07h
RO	2	Rated output	4E20h	80h	310Ah	08h
ZB	2	Zero balance	0000h	80h	310Ch	09h
GN	2	Gain	1000h	80h	310Eh	0Ah
TA	2	Tara	0000h	80h	3110h	0Bh
NL	2	Nominal load	0002h	80h	3112h	0Ch
SF	2	Scale factor	03E8h	80h	3114h	0Dh
SST	2	Steady state tolerance	0005h	80h	3116h	0Eh
SSW	2	Steady state window	03E8h	80h	3118h	0Fh
RL	4	Reference load	00000100h	80h	311Ah	10h

1) This record set may only be transferred at STOP state.

#### DIAG\_EN Diagnostic interrupt

Byte	Bit 7 ... 0
0	<ul style="list-style-type: none"> <li>■ Diagnostic interrupt               <ul style="list-style-type: none"> <li>- 00h: disable</li> <li>- 40h: enable</li> </ul> </li> </ul>

- Here you activate respectively de-activate the diagnostic function.

#### UEXC select power supply

Byte	Bit 7 ... 0
0	<ul style="list-style-type: none"> <li>■ Power supply               <ul style="list-style-type: none"> <li>- 00h: 2.5V</li> <li>- 01h: 5V</li> <li>- 02h: 7.5V</li> <li>- 03h: 10V</li> <li>- 04h: 12V</li> </ul> </li> </ul>



- Here you can specify the power supply for the excitation voltage  $U_{EXC}$ , which the module provides via the pins EXC+ und EXC-.



*Please always use the excitation voltage  $U$  of the module $_{EXC}$ ! The connection of strain gauge DMS sensors with external power supply is not possible.*

### CAL Calibration interval

Byte	Bit 7 ... 0
0...1	<ul style="list-style-type: none"> <li>■ Interval for the calibration.               <ul style="list-style-type: none"> <li>- Calibration interval as 100ms value</li> <li>- 00h: de-activates the calibration</li> </ul> </li> </ul>

- By setting a calibration interval as 100ms value, the self-calibration is always performed after this time.
- With the self-calibration the internal offset and gain error may be compensated.
- There is always the entire signal path including all passive components checked.
- During self-calibration, the CAL LED is on and the measured value is frozen.
- 00h de-activates the calibration.

### MEAS Measurement method

Byte	Bit 7 ... 0
0	<ul style="list-style-type: none"> <li>■ Measurement method               <ul style="list-style-type: none"> <li>- 23h: 6 wire measurement</li> <li>- 25h: 4 wire measurement</li> <li>- FFh: de-activated</li> </ul> </li> </ul>

- Here you can choose between 4 and 6 wire measurement respectively disable the measurement.

### FILT Filter selection

Byte	Bit 7 ... 0
0	<ul style="list-style-type: none"> <li>■ Filter selection               <ul style="list-style-type: none"> <li>- 00h: Filter de-activated</li> <li>- 01h: Activate dynamic IIR filter</li> <li>- 02h: IIR1</li> <li>- 03h: IIR2</li> <li>- 04h: IIR3</li> <li>- 05h: IIR4</li> <li>- 06h: IIR5</li> <li>- 07h: IIR6</li> <li>- 08h: IIR7</li> <li>- 09h: IIR8</li> <li>- 0Ah: FIR 50Hz</li> <li>- 0Bh: FIR 60Hz</li> </ul> </li> </ul>

#### Filter functions

- FIR 50/60 Hz
  - Suppression of mains frequency interference

- Dynamic IIR filter
  - automatic selection
  - Filter selection dependent on the current weight change
- Static IIR filter
  - De-activation respectively fix setting of a filter level (IIR1...IIR8)

**DFCT Dynamic Filter Change Time**

Byte	Bit 7 ... 0
0...1	Sampling rate for filter change-over in ms

- Here you can specify the time for re-evaluation for the filter change-over in ms.

**DFD Dynamic filter delta**

Byte	Bit 7 ... 0
0...1	Limit value for filter change-over

- Here you can specify the limit value for the filter change-over.

**RO Rated output**

Byte	Bit 7 ... 0
0...1	Rated output in 0.0001mV/V

- Here you can specify the rated output in 0.0001mV/V. Information to the rated output can be found in the data sheet of you force transducer.

**ZB Zero balance**

Byte	Bit 7 ... 0
0...1	Zero balance in 0.0001mV/V

- Here you can specify the zero balance as 0.0001mV/V value. Information to the zero balance can be found in the data sheet of you force transducer.

**GN Gain**

Byte	Bit 7 ... 0
0...1	Gain for user scaling of the output value

- Here you can specify a factor as  $2^{-12}$  value. The factor is multiplied with the output value.

**TA Tara**

Byte	Bit 7 ... 0
0...1	User offset for the output value

- Here you can specify an offset as  $2^{-12}$  value. The offset is added to the determined output value.

**NL Nominal load**

Byte	Bit 7 ... 0
0...1	Nominal load of the force transducer

- Here you can specify the nominal load of the force transducer unit-free. Information to nominal load can be found in the data sheet of you force transducer.

**SF Scale factor process data**

Byte	Bit 7 ... 0
0...1	Scale factor for the nominal load

- Here you can specify the scale factor for the nominal load, such as to convert kg to g.
  - Example: Nominal load in kg and scale factor 1000 (03E8h) results display in g.

**SST Steady state tolerance**

Byte	Bit 7 ... 0
0...1	Tolerance for <i>Steady State</i>

- Here you can specify a tolerance window for the state *Steady State*. This is specified as a deviation of the scaled nominal load.
  - Example: With a rated load in kg and scaling factor of 1000 (03E8h) you must specify the value 0005h to set a tolerance window of 5g.

**SSW Steady state window**

Byte	Bit 7 ... 0
0...1	Time interval for <i>Steady State</i> in ms

- Here you can specify a time interval for the setting of the *Steady State* bit (DMS\_STAT-Bit 1).
- If the measured value is within the tolerance window SST longer than the time interval SSW, then bit 1 of the status word DMS\_STAT is set.

**RL Reference load**

Byte	Bit 7 ... 0
0...3	Reference load for the calibration

- Here you can specify the reference load for the calibration unit-free. The reference load must be at least 20% of the *Nominal load* NL.

**3.16.6 Deployment of the filter functions****Overview**

The module has the following filter functions, which can be activated via the parametrization:

- FIR 50/60 Hz
- Dynamic IIR filter
- Static IIR filter

**FIR 50/60 Hz**

In the parametrization via FILT you can specify the filter *FIR 50 Hz* respectively *FIR 60 Hz*. These filters acts a notch filter. Notch filter generate at the configured frequency and the multiple thereof zeros (notches) in the frequency response. They attenuate these frequencies here in the amplitude. When filters are used, these influence the conversion time of your module. The higher the filter frequency, the faster the conversion time. This can be used for the suppression of mains frequency interferences.

**Dynamic IIR filter**

- By activation of the dynamic IIR filter in the FILT parameter, dependent on the current weight change, it is automatically switched between 8 different filters. The aim here is to obtain a filter with the best possible damping, which must lead to stable measuring values. The *Dynamic IIR filter* acts as 1. order low-pass filter and has the following properties:
  - If there is a rapid change of the input value, it is switched-over to the next lower filter (e.g. IIR1→IIR2). In this way the load changes are less precise, but it is faster recognized.
  - If there is small change in the measured value, it is switched-over to the next higher filter (e.g. IIR2→IIR1), so you will get a higher precision.
  - With the IIR1 filter you get the lowest noise suppression and the most unstable measured value.
  - With the IIR8 filter you get the highest noise suppression and the most stable measured value.
  - The reevaluation, which can lead to a modification of the filter levels, takes place in a fixed interval, which can be specified via parameter *DFCT* in ms.

Filter level	Limit frequency	Filter constant	Rise time 10-90% [s] (typ.)
02h: IIR1	1000	$a_0 = 0.5$	0.0003
03h: IIR2	500Hz	$a_0 = 0.25$	0.0008
04h: IIR3	125Hz	$a_0 = 62.5 \times 10^{-3}$	0.0035
05h: IIR4	30Hz	$a_0 = 15.6 \times 10^{-3}$	0.014
06h: IIR5	8Hz	$a_0 = 3.91 \times 10^{-3}$	0.056
07h: IIR6	2Hz	$a_0 = 977 \times 10^{-6}$	0.225
08h: IIR7	0.5Hz	$a_0 = 244 \times 10^{-6}$	0.9
09h: IIR8	0.1Hz	$a_0 = 61.0 \times 10^{-6}$	3.6

**Prevent overriding the filter**

By a brief activation of *Input Freeze* in the command byte *DMS\_CMD* pulses, e.g. caused by a filling procedure can be prevented, which would override the filter unnecessarily. As soon as *Input Freeze* is activated, no measurement values are passed to the digital filter.

**Static IIR filter**

Via the FILT parameter you can de-activate the filter function or you can specify a fix filter level (IIR1...IIR8).

**3.16.7 Calibration****Proceeding**

Please use for the calibration the IIR8 filter (FILT = 09h - slow). The following steps are necessary for the calibration:

1. Specify in the parametrization the *Reference load* RL. The *Reference load* must be at least 20% of the *Nominal load*.
2. Operate the balance without load.
3. As soon as a stable value is shown, set bit 6 (set zero point) in the command byte *DMS\_CMD*.
4. Apply the balance with the reference load. As soon as a stable value is shown, set bit 7 (set reference point) in the command byte *DMS\_CMD*.
5. Set bit 1 (store adjustment) in the command byte *DMS\_CMD*.
  - ➔ As soon as the adjustment data were stored successfully, the module measures with these parameters.

6. → Remove the reference weight again and wait until a stable value is shown.
7. → Tare the balance by setting bit 3 (set tare) in the *DMS\_CMD* command byte.
  - ➔ The calibration is complete.
    - The adjustment data remain even after a power loss condition and can be deleted (delete adjustment) via bit 2.
    - The adjustment data can be rewritten every 120 seconds.

### 3.16.8 Steady state detection

#### Functionality

- If the measured value is within the range of values *SST* longer than the time interval *SSW*, then bit 1 (steady state active) of the status word *DMS\_STAT* is set. The current measured value is used as the starting point for the range of values and the steady state timer is started. → '*DMS\_STAT Status*'...page 190
- If the measured value remains within *SST* over the period *SSW*, the steady-state bit is set.
- If the tolerance range *SST* is exceeded, the last measured value is used as starting point and the time is newly started.
- The values *SSW* and *SST* can be specified by the parametrization. → '*Parameter data*'...page 196

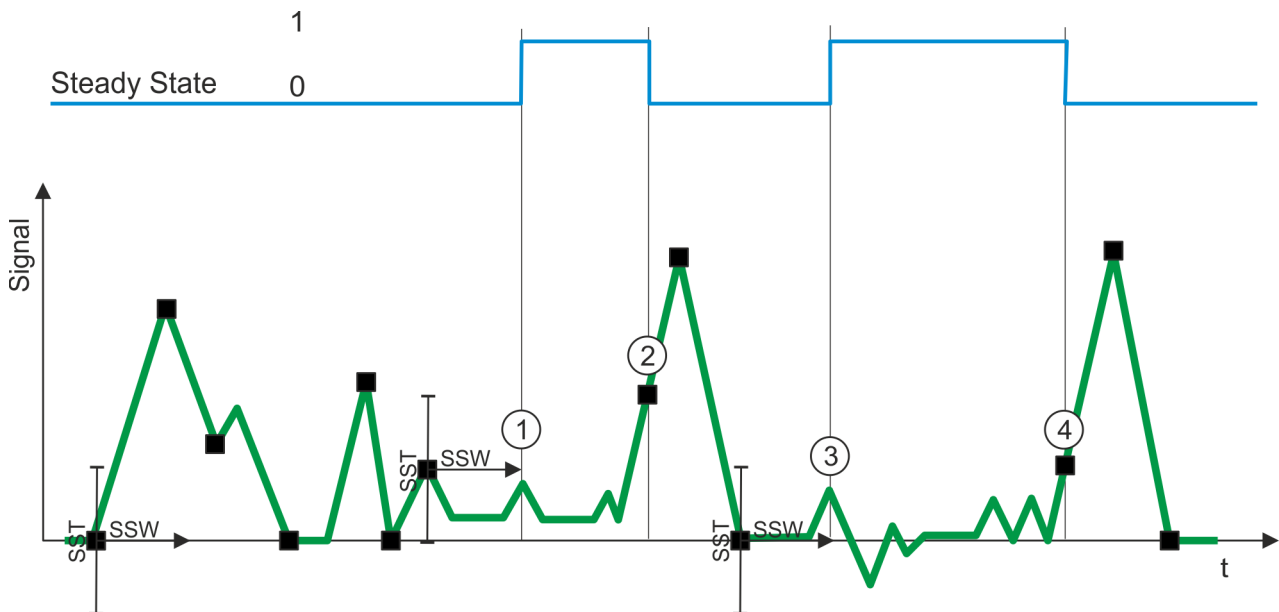

- Starting point of the *SSW* timer is newly started. Only when the measured signal is longer than the time *SSW* within the range of values *SST*, steady state is set.
- [1] *SSW* timer has expired and the measured signal is within the range of values → Steady state bit is set.
- [2] Measured signal exceeds the range of values → Steady state bit is reset.
- [3] *SSW* timer has expired and the measured signal is within the range of values → Steady state bit is set.
- [4] Measured signal exceeds the range of values → Steady state bit is reset.

### 3.16.9 Diagnostics

#### Diagnostic data

Via the parametrization you may activate a diagnostic interrupt for the module. With a diagnostics interrupt the module serves for diagnostics data for diagnostic interrupt<sub>incoming</sub>. As soon as the reason for releasing a diagnostic interrupt is no longer present, the diagnostic interrupt<sub>going</sub> automatically takes place. All events of a channel between diagnostic interrupt<sub>incoming</sub> and diagnostic interrupt<sub>going</sub> are not stored and get lost. Within this time window (1. diagnostic interrupt<sub>incoming</sub> until last diagnostic interrupt<sub>going</sub>) the MF-LED of the module is on.

The following events can cause a diagnostic interrupt:

- External auxiliary supply is missing
- Internal diagnostic puffer overflow
- Internal communication error
- Project engineering/parametrization error
- Measuring range underflow
- Measuring range overflow

**DS** Record set for access via CPU, PROFIBUS and PROFINET. The access happens by DS 01h. Additionally the first 4 bytes may be accessed by DS 00h.

**IX** Index for access via CANopen. The access happens by IX 2F01h. Additionally the first 4 bytes may be accessed by IX 2F00h.

**SX** Subindex for access via EtherCAT with Index 5005h.

More can be found in the according manual of your bus coupler.

Name	Bytes	Function	Default	DS	IX	SX
ERR_A	1	Diagnostic	00h	01h	2F01h	02h
MODTYP	1	Module information	15h			03h
ERR_C	1	reserved	00h			04h
ERR_D	1	Diagnostic	00h			05h
CHTYP	1	Channel type	71h			06h
NUMBIT	1	Number diagnostic bits per channel	08h			07h
NUMCH	1	Number of channels of a module	01h			08h
CHERR	1	Channel error	00h			09h
CHxERR	8	Channel-specific error channel x	00h			0Ah...11h
DIAG_US	4	µs ticker	00h			13h

### ERR\_A Diagnostic

Byte	Bit 7 ... 0
0	<ul style="list-style-type: none"> <li>■ Bit 0: set at module failure</li> <li>■ Bit 1: reserved</li> <li>■ Bit 2: set at external error</li> <li>■ Bit 3: set at channel error</li> <li>■ Bit 4: set at external auxiliary supply missing</li> <li>■ Bit 6 ... 5: reserved</li> <li>■ Bit 7: set at error in parametrization</li> </ul>

### MODTYP Module information

Byte	Bit 7 ... 0
0	<ul style="list-style-type: none"> <li>■ Bit 3 ... 0: module class <ul style="list-style-type: none"> <li>– 0101b analog module</li> </ul> </li> <li>■ Bit 4: set at channel information present</li> <li>■ Bit 7 ... 5: reserved</li> </ul>

**ERR\_C reserved**

Byte	Bit 7 ... 0
0	reserved

**ERR\_D Diagnostic**

Byte	Bit 7 ... 0
0	<ul style="list-style-type: none"> <li>■ Bit 2 ... 0: reserved</li> <li>■ Bit 3: set at internal diagnostics buffer overflow</li> <li>■ Bit 4: set at internal communication error</li> <li>■ Bit 7 ... 5: reserved</li> </ul>

**CHTYP Channel type**

Byte	Bit 7 ... 0
0	<ul style="list-style-type: none"> <li>■ Bit 6 ... 0: Channel type <ul style="list-style-type: none"> <li>- 70h: Digital input</li> <li>- 71h: Analog input</li> <li>- 72h: Digital output</li> <li>- 73h: Analog output</li> <li>- 74h: Analog input/-output</li> <li>- 76h: Counter</li> </ul> </li> <li>■ Bit 7: reserved</li> </ul>

**NUMBIT Diagnostic bits**

Byte	Bit 7 ... 0
0	Number of diagnostic bits per channel (here 08h)

**NUMCH Channels**

Byte	Bit 7 ... 0
0	Number of channels of the module (here 01h)

**CHERR Channel error**

Byte	Bit 7 ... 0
0	<ul style="list-style-type: none"> <li>■ Bit 0: set at error in channel 0</li> </ul>

**CHxERR Channel-specific**

Byte	Bit 7 ... 0
0	Channel-specific error channel 0 <ul style="list-style-type: none"> <li>■ Bit 0: set at project engineering respectively parametrization error</li> <li>■ Bit 2...1: reserved</li> <li>■ Bit 3: set at short circuit of excitation voltage <math>U_{EXC}</math></li> <li>■ Bit 5...4: reserved</li> <li>■ Bit 6: set at measuring range underflow</li> <li>■ Bit 7: set at measuring range overflow</li> </ul>
1...7	reserved

031-1CA20 - AI 1x16(24)Bit Strain gauge (DMS) > Diagnostics

**DIAG\_US  $\mu$ s ticker**

Byte	Bit 7 ... 0
0...3	Value of the $\mu$ s ticker at the moment of the diagnostic

 *$\mu$ s ticker*

In the System SLIO module there is a timer ( $\mu$ s ticker). With PowerON the timer starts counting with 0. After  $2^{32}-1\mu$ s the timer starts with 0 again.



### 3.17 031-1CB30 - AI 2x16Bit 0...10V

**Properties**

The electronic module has 2 inputs with parameterizable functions. The channels of the module are electrically isolated from the backplane bus. In addition, the channels are isolated to the DC 24V power supply by means of DC/DC converter.

- 2 analog inputs
- Suited for sensors with 0 ... 10V
- Interrupt and diagnostics function
- Interference frequency suppression parameterizable (50/60Hz)
- 16bit resolution

**Structure**

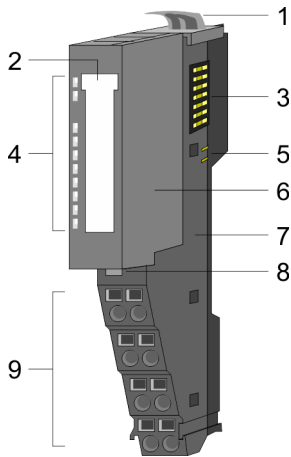

- 1 Locking lever terminal module
- 2 Labeling strip
- 3 Backplane bus
- 4 LED status indication
- 5 DC 24V power section supply
- 6 Electronic module
- 7 Terminal module
- 8 Locking lever electronic module
- 9 Terminal

**Status indication**

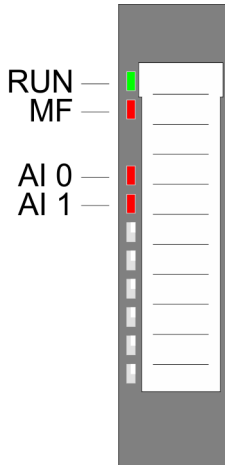

RUN	MF	AI x	Description
<input checked="" type="checkbox"/> green	<input checked="" type="checkbox"/> red	<input checked="" type="checkbox"/> red	
<input checked="" type="checkbox"/>	<input type="checkbox"/>	X	Bus communication is OK Module status is OK
<input checked="" type="checkbox"/>	<input checked="" type="checkbox"/>	X	Bus communication is OK Module status reports an error
<input type="checkbox"/>	<input checked="" type="checkbox"/>	X	Bus communication is not possible Module status reports an error
<input type="checkbox"/>	<input type="checkbox"/>	X	Error at bus power supply
X	<input checked="" type="checkbox"/>	X	Error in configuration → <a href="#">‘Trouble shooting - LEDs’...page 41</a>
<input checked="" type="checkbox"/>	<input type="checkbox"/>	<input checked="" type="checkbox"/>	Error channel x <ul style="list-style-type: none"> <li>■ Signal leaves measuring range</li> <li>■ Error in parameterization</li> </ul>
not relevant: X			

031-1CB30 - AI 2x16Bit 0...10V

**Pin assignment**

For wires with a cross section of 0.08mm<sup>2</sup> up to 1.5mm<sup>2</sup>.

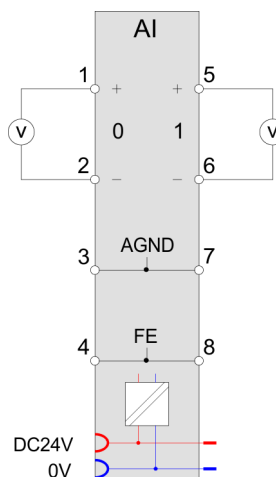
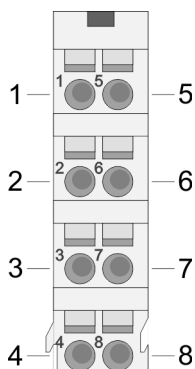

Pos.	Function	Type	Description
1	+AI 0	I	+ Channel 0
2	-AI 0	I	Ground Channel 0
3	AGND	I	Reference potential for differential-mode input
4	FE	I	Functional ground for cable shield (an additional shield bus carrier is not necessary)
5	+AI 1	I	+ Channel 1
6	-AI 1	I	Ground Channel 1
7	AGND	I	Reference potential for differential-mode input
8	FE	I	Functional ground for cable shield (an additional shield bus carrier is not necessary)

I: Input

**In-/Output area**

At CPU, PROFIBUS and PROFINET the input respectively output area is embedded to the corresponding address area.

IX Index for access via CANopen with s = Subindex, depends on number and type of analog modules

SX Subindex for access via EtherCAT with Index 6000h + EtherCAT-Slot

More can be found in the according manual of your bus coupler.

**Input area**

Addr.	Name	Bytes	Function	IX	SX
+0	AI 0	2	Analog value channel 0	6401h/s	01h
+2	AI 1	2	Analog value channel 1	6401h/s+1	02h

**Output area**

No byte of the output area is used by the module.

## 3.17.1 Technical data

Order no.	031-1CB30
Type	SM 031 - Analog input
Module ID	040A 1543
<b>Current consumption/power loss</b>	
Current consumption from backplane bus	60 mA
Power loss	0.8 W
<b>Technical data analog inputs</b>	
Number of inputs	2
Cable length, shielded	200 m
Rated load voltage	DC 24 V
Current consumption from load voltage L+ (without load)	20 mA
Voltage inputs	✓
Min. input resistance (voltage range)	200 kΩ
Input voltage ranges	0 V ... +10 V
Operational limit of voltage ranges	+/-0.2%
Operational limit of voltage ranges with SFU	-
Basic error limit voltage ranges	+/-0.1%
Basic error limit voltage ranges with SFU	-
Destruction limit voltage	max. 30V
Current inputs	-
Max. input resistance (current range)	-
Input current ranges	-
Operational limit of current ranges	-
Operational limit of current ranges with SFU	-
Basic error limit current ranges	-
Radical error limit current ranges with SFU	-
Destruction limit current inputs (voltage)	-
Destruction limit current inputs (electrical current)	-
Resistance inputs	-
Resistance ranges	-
Operational limit of resistor ranges	-
Operational limit of resistor ranges with SFU	-
Basic error limit	-
Basic error limit with SFU	-
Destruction limit resistance inputs	-
Resistance thermometer inputs	-
Resistance thermometer ranges	-
Operational limit of resistance thermometer ranges	-

031-1CB30 - AI 2x16Bit 0...10V &gt; Technical data

Order no.	031-1CB30
Operational limit of resistance thermometer ranges with SFU	-
Basic error limit thermoresistor ranges	-
Basic error limit thermoresistor ranges with SFU	-
Destruction limit resistance thermometer inputs	-
Thermocouple inputs	-
Thermocouple ranges	-
Operational limit of thermocouple ranges	-
Operational limit of thermocouple ranges with SFU	-
Basic error limit thermocouple ranges	-
Basic error limit thermocouple ranges with SFU	-
Destruction limit thermocouple inputs	-
Programmable temperature compensation	-
External temperature compensation	-
Internal temperature compensation	-
Temperature error internal compensation	-
Technical unit of temperature measurement	-
Resolution in bit	16
Measurement principle	successive approximation
Basic conversion time	240 µs all channels
Noise suppression for frequency	>80dB at 50Hz (UCM<9V)
<b>Status information, alarms, diagnostics</b>	
Status display	yes
Interrupts	yes, parameterizable
Process alarm	yes, parameterizable
Diagnostic interrupt	yes, parameterizable
Diagnostic functions	yes
Diagnostics information read-out	possible
Module state	green LED
Module error display	red LED
Channel error display	red LED per channel
<b>Isolation</b>	
Between channels	-
Between channels of groups to	-
Between channels and backplane bus	✓
Between channels and power supply	✓
Max. potential difference between circuits	-
Max. potential difference between inputs (Ucm)	DC 9 V

Order no.	031-1CB30
Max. potential difference between Mana and Mintern (Uiso)	-
Max. potential difference between inputs and Mana (Ucm)	DC 1 V
Max. potential difference between inputs and Mintern (Uiso)	DC 75 V/ AC 50 V
Max. potential difference between Mintern and outputs	-
Insulation tested with	DC 500 V
<b>Technical data encoder supply</b>	
Number of outputs	-
Output voltage (typ)	-
Output voltage (rated value)	-
Short-circuit protection	-
Binding of potential	-
<b>Datasizes</b>	
Input bytes	4
Output bytes	0
Parameter bytes	20
Diagnostic bytes	20
<b>Housing</b>	
Material	PPE / PPE GF10
Mounting	Profile rail 35 mm
<b>Mechanical data</b>	
Dimensions (WxHxD)	12.9 mm x 109 mm x 76.5 mm
Net weight	60 g
Weight including accessories	60 g
Gross weight	75 g
<b>Environmental conditions</b>	
Operating temperature	0 °C to 60 °C
Storage temperature	-25 °C to 70 °C
<b>Certifications</b>	
UL certification	yes
KC certification	yes
UKCA certification	yes
ChinaRoHS certification	yes

SFU

Interference frequency suppression

### 3.17.2 Parameter data

DS Record set for access via CPU, PROFIBUS and PROFINET

IX Index for access via CANopen

SX Subindex for access via EtherCAT with Index 3100h + EtherCAT-Slot

More can be found in the according manual of your bus coupler.

Name	Bytes	Function	Default	DS	IX	SX
DIAG	1	Diagnostics <sup>1</sup>	00h	00h	3100h	01h
RES1	1	reserved	00h	00h	3101h	02h
LIMIT_EN	1	Limit value monitoring <sup>1</sup>	00h	00h	3102h	03h
SUPR	1	Interference frequency suppression (SFU)	00h	01h	3103h	04h
CH0FN	1	Function number channel 0	10h	80h	3104h	05h
RES7	1	reserved	00h	80h	3105h	06h
CH0UL	2	Upper limit value channel 0	7FFFh	80h	3106h... 3107h	07h
CH0LL	2	Lower limit value channel 0	8000h	80h	3108h... 3109h	08h
CH1FN	1	Function number channel 1	10h	81h	310Ah	09h
RES13	1	reserved	00h	81h	310Bh	0Ah
CH1UL	2	Upper limit value channel 1	7FFFh	81h	310Ch... 310Dh	0Bh
CH1LL	2	Lower limit value channel 1	8000h	81h	310Eh... 310Fh	0Ch

1) This record set may only be transferred at STOP state.

#### DIAG\_EN Diagnostic interrupt

Byte	Bit 7 ... 0
0	<ul style="list-style-type: none"> <li>■ Diagnostic interrupt               <ul style="list-style-type: none"> <li>- 00h: disabled</li> <li>- 40h: enabled</li> </ul> </li> </ul>

- Here you can enable respectively disable the diagnostic interrupt.

#### LIMIT\_EN Limit value monitoring

Byte	Bit 7 ... 0
0	<ul style="list-style-type: none"> <li>■ Bit 0: Limit value monitoring channel 0 (1: on)</li> <li>■ Bit 1: Limit value monitoring channel 1 (1: on)</li> <li>■ Bit 7 ... 2: reserved</li> </ul>

**SUPR Interference frequency suppression (SFU)**

Byte	Bit 7 ... 0
0	<ul style="list-style-type: none"> <li>■ Bit 1, 0: Interference frequency suppression channel 0                             <ul style="list-style-type: none"> <li>- 00: deactivated</li> <li>- 01: 60Hz</li> <li>- 10: 50Hz</li> </ul> </li> <li>■ Bit 3, 2: Interference frequency suppression channel 1                             <ul style="list-style-type: none"> <li>- 00: deactivated</li> <li>- 01: 60Hz</li> <li>- 10: 50Hz</li> </ul> </li> <li>■ Bit 7 ... 4: reserved</li> </ul>

**CHxFN Function number channel x**

In the following there are the measuring ranges with function number listed, which were supported by the analog module. With FFh the corresponding channel is deactivated. The formulas listed here allow you to transform an evaluated measuring value (digital value) to a value assigned to the measuring range (analog value) and vice versa.

Meas. range Voltage 0 ... 10V (funct. no.)	Voltage (U)	Decimal (D)	Hex	Range	Formulas
0 ... 10V Siemens S7 format (10h)	11.76V	32511	7EFFh	overrange	$D = 27648 \cdot \frac{U}{10}$ $U = D \cdot \frac{10}{27648}$
	10V	27648	6C00h	nominal range	
	5V	13824	3600h		
	0V	0	0000h		
	-1.76V	-4864	ED00h	underrange	
0 ... 10V Siemens S5 format (20h)	12.5V	20480	5000h	overrange	$D = 16384 \cdot \frac{U}{10}$ $U = D \cdot \frac{10}{16384}$
	10V	16384	4000h	nominal range	
	5V	8192	2000h		
	0V	0	0000h		
	-2V	-3277	F333h	underrange	

**CHxUL CHxLL Upper limit value Lower limit value channel x**

For each channel an *upper* and a *lower limit* may be defined. Here only values of the nominal range may be preset, otherwise you receive a parameterization error. By presetting 7FFFh for the upper respectively 8000h for the lower limit value the corresponding limit is deactivated. As soon as the measuring value is beyond the limits and the limit value monitoring is activated, a hardware interrupt is initialized.

### 3.17.3 Diagnostics and interrupt

Event	Hardware interrupt	Diagnostics interrupt	parameterizable
Error in project engineering/parameterization	-	X	-
Measuring range overflow	-	X	-
Measuring range underflow	-	X	-
Limit overflow	X	-	X
Limit underflow	X	-	X
Diagnostic buffer overflow	-	X	-
Communication error	-	X	-
Hardware interrupt lost	-	X	-

#### Hardware interrupt

So you may react to asynchronous events, there is the possibility to activate a hardware interrupt.

- A hardware interrupt interrupts the linear program sequence and jumps depending on the master system to a corresponding Interrupt routine. Here you can react to the hardware interrupt accordingly.
- With CANopen the hardware interrupt data is transferred via an emergency telegram.
- Operating with CPU, PROFIBUS and PROFINET the hardware interrupt data were transferred via diagnostics telegram.

SX Subindex for access via EtherCAT with Index 5000h

More can be found in the according manual of your bus coupler.

Name	Bytes	Function	Default	SX
PRIT_OL	1	Upper limit overflow channel x	00h	02h
PRIT_UL	1	Lower limit underflow channel x	00h	03h
PRIT_US	2	µs-Ticker	00h	04h (high byte) 05h (low byte)

#### *PRIT\_OL Limit overflow*

Byte	Bit 7 ... 0
0	<ul style="list-style-type: none"> <li>■ Bit 0: Limit overflow channel 0</li> <li>■ Bit 1: Limit overflow channel 1</li> <li>■ Bit 7 ... 2: reserved</li> </ul>

#### *PRIT\_UL Limit underflow*

Byte	Bit 7 ... 0
0	<ul style="list-style-type: none"> <li>■ Bit 0: Limit underflow channel 0</li> <li>■ Bit 1: Limit underflow channel 1</li> <li>■ Bit 7 ... 2: reserved</li> </ul>



**PRIT\_US  $\mu$ s ticker**

Byte	Bit 7 ... 0
0 ... 1	Value of the $\mu$ s ticker at the moment of the diagnostic.

 **$\mu$ s ticker**

In the module there is a 32 bit timer ( $\mu$ s ticker). With PowerON the timer starts counting with 0. After  $2^{32}-1\mu$ s the timer starts with 0 again. PRIT\_US represents the lower 2 byte of the  $\mu$ s ticker value (0 ...  $2^{16}-1$ ).

**Diagnostic data**

Via the parametrization you may activate a diagnostic interrupt for the module. With a diagnostics interrupt the module serves for diagnostics data for diagnostic interrupt<sub>incoming</sub>. As soon as the reason for releasing a diagnostic interrupt is no longer present, the diagnostic interrupt<sub>going</sub> automatically takes place. All events of a channel between diagnostic interrupt<sub>incoming</sub> and diagnostic interrupt<sub>going</sub> are not stored and get lost. Within this time window (1. diagnostic interrupt<sub>incoming</sub> until last diagnostic interrupt<sub>going</sub>) the MF-LED of the module is on.

The following errors are listed in the diagnostics data:

- Error in project engineering / parameterization
- Measuring range overflow
- Measuring range underflow
- Hardware interrupt lost
- Power supply failed

DS Record set for access via CPU, PROFIBUS and PROFINET. The access happens by DS 01h. Additionally the first 4 bytes may be accessed by DS 00h.

IX Index for access via CANopen. The access happens by IX 2F01h. Additionally the first 4 bytes may be accessed by IX 2F00h.

SX Subindex for access via EtherCAT with Index 5005h.

More can be found in the according manual of your bus coupler.

Name	Bytes	Function	Default	DS	IX	SX
ERR_A	1	Diagnostic	00h	01h	2F01h	02h
MODTYP	1	Module information	15h			03h
ERR_C	1	reserved	00h			04h
ERR_D	1	Diagnostic	00h			05h
CHTYP	1	Channel type	71h			06h
NUMBIT	1	Number diagnostic bits per channel	08h			07h
NUMCH	1	Number of channels of a module	02h			08h
CHERR	1	Channel error	00h			09h
CH0ERR	1	Channel-specific error channel 0	00h			0Ah
CH1ERR	1	Channel-specific error channel 1	00h			0Bh
CH2ERR... CH7ERR	6	reserved	00h			0Ch ... 11h
DIAG_US	4	$\mu$ s ticker	00h			13h

031-1CB30 - AI 2x16Bit 0...10V &gt; Diagnostics and interrupt

**ERR\_A Diagnostic**

Byte	Bit 7 ... 0
0	<ul style="list-style-type: none"> <li>■ Bit 0: set at module failure</li> <li>■ Bit 1: set at internal error</li> <li>■ Bit 2: set at external error</li> <li>■ Bit 3: set at channel error</li> <li>■ Bit 4: set at external auxiliary supply missing</li> <li>■ Bit 6 ... 5: reserved</li> <li>■ Bit 7: set at error in parametrization</li> </ul>

**MODTYP  
Module information**

Byte	Bit 7 ... 0
0	<ul style="list-style-type: none"> <li>■ Bit 3 ... 0: module class <ul style="list-style-type: none"> <li>- 0101b analog module</li> </ul> </li> <li>■ Bit 4: set at channel information present</li> <li>■ Bit 7 ... 5: reserved</li> </ul>

**ERR\_D Diagnostic**

Byte	Bit 7 ... 0
0	<ul style="list-style-type: none"> <li>■ Bit 2 ... 0: reserved</li> <li>■ Bit 3: set at internal diagnostics buffer overflow</li> <li>■ Bit 4: set at internal communication error</li> <li>■ Bit 5: reserved</li> <li>■ Bit 6: set at hardware interrupt lost</li> <li>■ Bit 7: reserved</li> </ul>

**CHTYP Channel type**

Byte	Bit 7 ... 0
0	<ul style="list-style-type: none"> <li>■ Bit 6 ... 0: Channel type <ul style="list-style-type: none"> <li>- 70h: Digital input</li> <li>- 71h: Analog input</li> <li>- 72h: Digital output</li> <li>- 73h: Analog output</li> <li>- 74h: Analog input/-output</li> <li>- 76h: Counter</li> </ul> </li> <li>■ Bit 7: reserved</li> </ul>

**NUMBIT Diagnostic bits**

Byte	Bit 7 ... 0
0	Number of diagnostic bits per channel (here 08h)

**NUMCH Channels**

Byte	Bit 7 ... 0
0	Number of channels of a module (here 02h)

**CHERR Channel error**

Byte	Bit 7 ... 0
0	<ul style="list-style-type: none"> <li>■ Bit 0: set at error in channel group 0</li> <li>■ Bit 1: set at error in channel group 1</li> <li>■ Bit 7 ... 2: reserved</li> </ul>

**CH0ERR CH1ERR  
Channel-specific**

Byte	Bit 7 ... 0
0	Channel-specific error channel x: <ul style="list-style-type: none"> <li>■ Bit 0: set at configuring/parameter assignment error</li> <li>■ Bit 4 ... 1: reserved</li> <li>■ Bit 5: set at hardware interrupt lost</li> <li>■ Bit 6: set at measuring range underflow</li> <li>■ Bit 7: set at measuring range overflow</li> </ul>

**DIAG\_US  $\mu$ s ticker**

Byte	Bit 7 ... 0
0...3	Value of the $\mu$ s ticker at the moment of the diagnostic

 *$\mu$ s ticker*

In the System SLIO module there is a timer ( $\mu$ s ticker). With PowerON the timer starts counting with 0. After  $2^{32}-1\mu$ s the timer starts with 0 again.

031-1CB40 - AI 2x16Bit 0(4)...20mA

### 3.18 031-1CB40 - AI 2x16Bit 0(4)...20mA

#### Properties

The electronic module has 2 inputs with parameterizable functions. The channels of the module are electrically isolated from the backplane bus. In addition, the channels are isolated to the DC 24V power supply by means of DC/DC converter.

- 2 analog inputs
- Suited for sensors with 0 ... 20mA;  
4 ... 20mA with external supply
- Interrupt and diagnostics function
- Interference frequency suppression parameterizable (50/60Hz)
- 16bit resolution

#### Structure

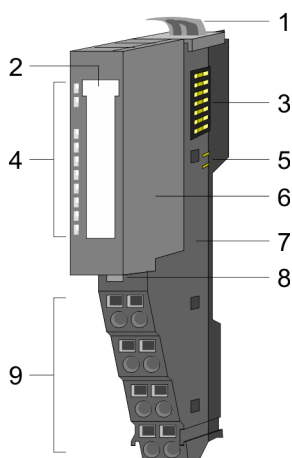

- 1 Locking lever terminal module
- 2 Labeling strip
- 3 Backplane bus
- 4 LED status indication
- 5 DC 24V power section supply
- 6 Electronic module
- 7 Terminal module
- 8 Locking lever electronic module
- 9 Terminal

#### Status indication

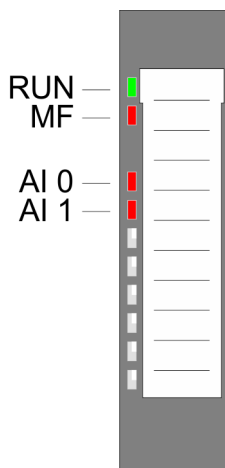

RUN	MF	AI x	Description
<input checked="" type="checkbox"/> green	<input checked="" type="checkbox"/> red	<input checked="" type="checkbox"/> red	
<input checked="" type="checkbox"/>	<input type="checkbox"/>	X	Bus communication is OK Module status is OK
<input checked="" type="checkbox"/>	<input checked="" type="checkbox"/>	X	Bus communication is OK Module status reports an error
<input type="checkbox"/>	<input checked="" type="checkbox"/>	X	Bus communication is not possible Module status reports an error
<input type="checkbox"/>	<input type="checkbox"/>	X	Error at bus power supply
X	<input checked="" type="checkbox"/>	X	Error in configuration → <a href="#">‘Trouble shooting - LEDs’...page 41</a>
<input checked="" type="checkbox"/>	<input type="checkbox"/>	<input checked="" type="checkbox"/>	Error channel x <ul style="list-style-type: none"> <li>■ Signal leaves measuring range</li> <li>■ Error in parameterization</li> </ul>
not relevant: X			

**Pin assignment**

For wires with a cross section of 0.08mm<sup>2</sup> up to 1.5mm<sup>2</sup>.

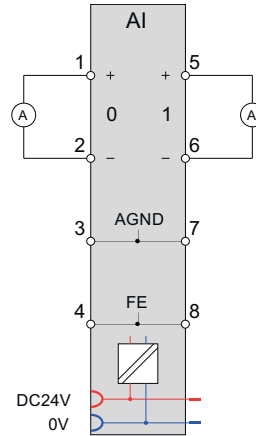
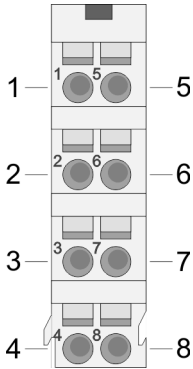

Pos.	Function	Type	Description
1	+AI 0	I	+ Channel 0
2	-AI 0	I	Ground Channel 0
3	AGND	I	Reference potential for differential-mode input
4	FE	I	Functional ground for cable shield (an additional shield bus carrier is not necessary)
5	+AI 1	I	+ Channel 1
6	-AI 1	I	Ground Channel 1
7	AGND	I	Reference potential for differential-mode input
8	FE	I	Functional ground for cable shield (an additional shield bus carrier is not necessary)

I: Input



*If a 2wire measuring transducer is used, you have to connect in line an external power supply.*

**In-/Output area**

At CPU, PROFIBUS and PROFINET the input respectively output area is embedded to the corresponding address area.

IX Index for access via CANopen with s = Subindex, depends on number and type of analog modules

SX Subindex for access via EtherCAT with Index 6000h + EtherCAT-Slot

More can be found in the according manual of your bus coupler.

**Input area**

Addr.	Name	Bytes	Function	IX	SX
+0	AI 0	2	Analog value channel 0	6401h/s	01h
+2	AI 1	2	Analog value channel 1	6401h/s+1	02h

**Output area**

No byte of the output area is used by the module.

## 3.18.1 Technical data

Order no.	031-1CB40
Type	SM 031 - Analog input
Module ID	040B 1543
<b>Current consumption/power loss</b>	
Current consumption from backplane bus	60 mA
Power loss	0.7 W
<b>Technical data analog inputs</b>	
Number of inputs	2
Cable length, shielded	200 m
Rated load voltage	DC 24 V
Current consumption from load voltage L+ (without load)	15 mA
Voltage inputs	-
Min. input resistance (voltage range)	-
Input voltage ranges	-
Operational limit of voltage ranges	-
Operational limit of voltage ranges with SFU	-
Basic error limit voltage ranges	-
Basic error limit voltage ranges with SFU	-
Destruction limit voltage	-
Current inputs	✓
Max. input resistance (current range)	60 Ω
Input current ranges	0 mA ... +20 mA +4 mA ... +20 mA
Operational limit of current ranges	+/-0.2%
Operational limit of current ranges with SFU	-
Basic error limit current ranges	+/-0.1%
Radical error limit current ranges with SFU	-
Destruction limit current inputs (voltage)	max. 24V
Destruction limit current inputs (electrical current)	max. 40mA
Resistance inputs	-
Resistance ranges	-
Operational limit of resistor ranges	-
Operational limit of resistor ranges with SFU	-
Basic error limit	-
Basic error limit with SFU	-
Destruction limit resistance inputs	-
Resistance thermometer inputs	-
Resistance thermometer ranges	-

Order no.	031-1CB40
Operational limit of resistance thermometer ranges	-
Operational limit of resistance thermometer ranges with SFU	-
Basic error limit thermoresistor ranges	-
Basic error limit thermoresistor ranges with SFU	-
Destruction limit resistance thermometer inputs	-
Thermocouple inputs	-
Thermocouple ranges	-
Operational limit of thermocouple ranges	-
Operational limit of thermocouple ranges with SFU	-
Basic error limit thermocouple ranges	-
Basic error limit thermocouple ranges with SFU	-
Destruction limit thermocouple inputs	-
Programmable temperature compensation	-
External temperature compensation	-
Internal temperature compensation	-
Temperature error internal compensation	-
Technical unit of temperature measurement	-
Resolution in bit	16
Measurement principle	successive approximation
Basic conversion time	240 µs all channels
Noise suppression for frequency	>80dB (UCM<4V)
<b>Status information, alarms, diagnostics</b>	
Status display	yes
Interrupts	yes, parameterizable
Process alarm	yes, parameterizable
Diagnostic interrupt	yes, parameterizable
Diagnostic functions	yes
Diagnostics information read-out	possible
Module state	green LED
Module error display	red LED
Channel error display	red LED per channel
<b>Isolation</b>	
Between channels	-
Between channels of groups to	-
Between channels and backplane bus	✓
Between channels and power supply	✓
Max. potential difference between circuits	-

031-1CB40 - AI 2x16Bit 0(4)...20mA &gt; Technical data

Order no.	031-1CB40
Max. potential difference between inputs (Ucm)	DC 4 V
Max. potential difference between Mana and Mintern (Uiso)	-
Max. potential difference between inputs and Mana (Ucm)	DC 3 V
Max. potential difference between inputs and Mintern (Uiso)	DC 75 V/ AC 50 V
Max. potential difference between Mintern and outputs	-
Insulation tested with	DC 500 V
<b>Technical data encoder supply</b>	
Number of outputs	-
Output voltage (typ)	-
Output voltage (rated value)	-
Short-circuit protection	-
Binding of potential	-
<b>Datasizes</b>	
Input bytes	4
Output bytes	0
Parameter bytes	20
Diagnostic bytes	20
<b>Housing</b>	
Material	PPE / PPE GF10
Mounting	Profile rail 35 mm
<b>Mechanical data</b>	
Dimensions (WxHxD)	12.9 mm x 109 mm x 76.5 mm
Net weight	60 g
Weight including accessories	60 g
Gross weight	74 g
<b>Environmental conditions</b>	
Operating temperature	0 °C to 60 °C
Storage temperature	-25 °C to 70 °C
<b>Certifications</b>	
UL certification	yes
KC certification	yes
UKCA certification	yes
ChinaRoHS certification	yes

SFU

Interference frequency suppression



### 3.18.2 Parameter data

DS Record set for access via CPU, PROFIBUS and PROFINET

IX Index for access via CANopen

SX Subindex for access via EtherCAT with Index 3100h + EtherCAT-Slot

More can be found in the according manual of your bus coupler.

Name	Bytes	Function	Default	DS	IX	SX
DIAG_EN	1	Diagnostics <sup>1</sup>	00h	00h	3100h	01h
RES1	1	reserved	00h	00h	3101h	02h
LIMIT_EN	1	Limit value monitoring <sup>1</sup>	00h	00h	3102h	03h
SUPR	1	Interference frequency suppression (SFU)	00h	01h	3103h	04h
CH0FN	1	Function number channel 0	31h	80h	3104h	05h
RES7	1	reserved	00h	80h	3105h	06h
CH0UL	2	Upper limit value channel 0	7FFFh	80h	3106h... 3107h	07h
CH0LL	2	Lower limit value channel 0	8000h	80h	3108h... 3109h	08h
CH1FN	1	Function number channel 1	31h	81h	310Ah	09h
RES13	1	reserved	00h	81h	310Bh	0Ah
CH1UL	2	Upper limit value channel 1	7FFFh	81h	310Ch... 310Dh	0Bh
CH1LL	2	Lower limit value channel 1	8000h	81h	310Eh... 310Fh	0Ch

1) This record set may only be transferred at STOP state.

#### DIAG\_EN Diagnostic interrupt

Byte	Bit 7 ... 0
0	<ul style="list-style-type: none"> <li>■ Diagnostic interrupt               <ul style="list-style-type: none"> <li>- 00h: disabled</li> <li>- 40h: enabled</li> </ul> </li> </ul>

- Here you can enable respectively disable the diagnostic interrupt.

#### LIMIT\_EN Limit value monitoring

Byte	Bit 7 ... 0
0	<ul style="list-style-type: none"> <li>■ Bit 0: Limit value monitoring channel 0 (1: on)</li> <li>■ Bit 1: Limit value monitoring channel 1 (1: on)</li> <li>■ Bit 7 ... 2: reserved</li> </ul>

**SUPR Interference frequency suppression (SFU)**

Byte	Bit 7 ... 0
0	<ul style="list-style-type: none"> <li>■ Bit 1, 0: Interference frequency suppression channel 0               <ul style="list-style-type: none"> <li>- 00: deactivated</li> <li>- 01: 60Hz</li> <li>- 10: 50Hz</li> </ul> </li> <li>■ Bit 3, 2: Interference frequency suppression channel 1               <ul style="list-style-type: none"> <li>- 00: deactivated</li> <li>- 01: 60Hz</li> <li>- 10: 50Hz</li> </ul> </li> <li>■ Bit 7 ... 4: reserved</li> </ul>

**CHxFN Function number channel x**

In the following there are the measuring ranges with corresponding function number listed, which were supported by the analog module. With FFh the corresponding channel is deactivated. The formulas listed here allow you to transform an evaluated measuring value (digital value) to a value assigned to the measuring range (analog value) and vice versa.

Meas. range Current 0(4) ... 20mA (funct. no.)	Current (I)	Decimal (D)	Hex	Range	Formulas
0 ... 20mA Siemens S7 format (31h)	23.52mA	32511	7EFFh	overrange	$D = 27648 \cdot \frac{I}{20}$ $I = D \cdot \frac{20}{27648}$
	20mA	27648	6C00h	nominal range	
	10mA	13824	3600h		
	0mA	0	0000h		
	-3.52mA	-4864	ED00h	underrange	
0 ... 20mA Siemens S5 format (41h)	25.00mA	20480	5000h	overrange	$D = 16384 \cdot \frac{I}{20}$ $I = D \cdot \frac{20}{16384}$
	20mA	16384	4000h	nominal range	
	10mA	8192	2000h		
	0mA	0	0000h		
	-4,00mA	-3277	F333h	underrange	
4 ... 20mA Siemens S7 format (30h)	22.81mA	32511	7EFFh	overrange	$D = 27648 \cdot \frac{I-4}{16}$ $I = D \cdot \frac{16}{27648} + 4$
	20mA	27648	6C00h	nominal range	
	12mA	13824	3600h		
	4mA	0	0000h		
	1.19mA	-4864	ED00h	underrange	
4 ... 20mA Siemens S5 format (40h)	24.00mA	20480	5000h	overrange	$D = 16384 \cdot \frac{I-4}{16}$ $I = D \cdot \frac{16}{16384} + 4$
	20mA	16384	4000h	nominal range	
	12mA	8192	2000h		
	4mA	0	0000h		
	0.8mA	-3277	F333h	underrange	

**CHxUL CHxLL Upper limit value Lower limit value channel x**

For each channel an *upper* and a *lower limit* may be defined. Here only values of the nominal range may be preset, otherwise you receive a parameterization error. By presetting 7FFFh for the upper respectively 8000h for the lower limit value the corresponding limit is deactivated. As soon as the measuring value is beyond the limits and the limit value monitoring is activated, a hardware interrupt is initialized.

**3.18.3 Diagnostics and interrupt**

Event	Hardware interrupt	Diagnostics interrupt	parameterizable
Error in project engineering/parameterization	-	X	-
Measuring range overflow	-	X	-
Measuring range underflow	-	X	-
Limit overflow	X	-	X
Limit underflow	X	-	X
Diagnostic buffer overflow	-	X	-
Communication error	-	X	-
Hardware interrupt lost	-	X	-

**Hardware interrupt**

So you may react to asynchronous events, there is the possibility to activate a hardware interrupt.

- A hardware interrupt interrupts the linear program sequence and jumps depending on the master system to a corresponding Interrupt routine. Here you can react to the hardware interrupt accordingly.
- With CANopen the hardware interrupt data is transferred via an emergency telegram.
- Operating with CPU, PROFIBUS and PROFINET the hardware interrupt data were transferred via diagnostics telegram.

SX Subindex for access via EtherCAT with Index 5000h

More can be found in the according manual of your bus coupler.

Name	Bytes	Function	Default	SX
PRIT_OL	1	Upper limit overflow channel x	00h	02h
PRIT_UL	1	Lower limit underflow channel x	00h	03h
PRIT_US	2	µs-Ticker	00h	04h (high byte) 05h (low byte)

**PRIT\_OL Limit overflow**

Byte	Bit 7 ... 0
0	<ul style="list-style-type: none"> <li>■ Bit 0: Limit overflow channel 0</li> <li>■ Bit 1: Limit overflow channel 1</li> <li>■ Bit 7 ... 2: reserved</li> </ul>

031-1CB40 - AI 2x16Bit 0(4)...20mA &gt; Diagnostics and interrupt

**PRIT\_UL Limit underflow**

Byte	Bit 7 ... 0
0	<ul style="list-style-type: none"> <li>■ Bit 0: Limit underflow channel 0</li> <li>■ Bit 1: Limit underflow channel 1</li> <li>■ Bit 7 ... 2: reserved</li> </ul>

**PRIT\_US  $\mu$ s ticker**

Byte	Bit 7 ... 0
0 ... 1	Value of the $\mu$ s ticker at the moment of the diagnostic.

**PRIT\_US  $\mu$ s ticker**

In the module there is a 32 bit timer ( $\mu$ s ticker). With PowerON the timer starts counting with 0. After 232-1 $\mu$ s the timer starts with 0 again. PRIT\_US represents the lower 2 byte of the  $\mu$ s ticker value (0 ...  $2^{16}-1$ ).

**Diagnostic data**

Via the parametrization you may activate a diagnostic interrupt for the module. With a diagnostics interrupt the module serves for diagnostics data for diagnostic interrupt<sub>incoming</sub>. As soon as the reason for releasing a diagnostic interrupt is no longer present, the diagnostic interrupt<sub>going</sub> automatically takes place. All events of a channel between diagnostic interrupt<sub>incoming</sub> and diagnostic interrupt<sub>going</sub> are not stored and get lost. Within this time window (1. diagnostic interrupt<sub>incoming</sub> until last diagnostic interrupt<sub>going</sub>) the MF-LED of the module is on.

The following errors are listed in the diagnostics data:

- Error in project engineering / parameterization
- Measuring range overflow
- Measuring range underflow
- Hardware interrupt lost
- Power supply failed

DS Record set for access via CPU, PROFIBUS and PROFINET. The access happens by DS 01h. Additionally the first 4 bytes may be accessed by DS 00h.

IX Index for access via CANopen. The access happens by IX 2F01h. Additionally the first 4 bytes may be accessed by IX 2F00h.

SX Subindex for access via EtherCAT with Index 5005h.

More can be found in the according manual of your bus coupler.

Name	Bytes	Function	Default	DS	IX	SX
ERR_A	1	Diagnostic	00h	01h	2F01h	02h
MODTYP	1	Module information	15h			03h
ERR_C	1	reserved	00h			04h
ERR_D	1	Diagnostic	00h			05h
CHTYP	1	Channel type	71h			06h
NUMBIT	1	Number diagnostic bits per channel	08h			07h
NUMCH	1	Number of channels of a module	02h			08h
CHERR	1	Channel error	00h			09h
CH0ERR	1	Channel-specific error channel 0	00h			0Ah
CH1ERR	1	Channel-specific error channel 1	00h			0Bh
CH2ERR...CH7 ERR	6	reserved	00h			0Ch ... 11h
DIAG_US	4	µs ticker	00h			13h

**ERR\_A Diagnostic**

Byte	Bit 7 ... 0
0	<ul style="list-style-type: none"> <li>■ Bit 0: set at module failure</li> <li>■ Bit 1: set at internal error</li> <li>■ Bit 2: set at external error</li> <li>■ Bit 3: set at channel error</li> <li>■ Bit 4: set at external auxiliary supply missing</li> <li>■ Bit 6 ... 5: reserved</li> <li>■ Bit 7: set at error in parametrization</li> </ul>

**MODTYP  
Module information**

Byte	Bit 7 ... 0
0	<ul style="list-style-type: none"> <li>■ Bit 3 ... 0: module class <ul style="list-style-type: none"> <li>– 0101b analog module</li> </ul> </li> <li>■ Bit 4: set at channel information present</li> <li>■ Bit 7 ... 5: reserved</li> </ul>

**ERR\_D Diagnostic**

Byte	Bit 7 ... 0
0	<ul style="list-style-type: none"> <li>■ Bit 2 ... 0: reserved</li> <li>■ Bit 3: set at internal diagnostics buffer overflow</li> <li>■ Bit 4: set at internal communication error</li> <li>■ Bit 5: reserved</li> <li>■ Bit 6: set at hardware interrupt lost</li> <li>■ Bit 7: reserved</li> </ul>

**CHTYP Channel type**

Byte	Bit 7 ... 0
0	<ul style="list-style-type: none"> <li>■ Bit 6 ... 0: Channel type               <ul style="list-style-type: none"> <li>- 70h: Digital input</li> <li>- 71h: Analog input</li> <li>- 72h: Digital output</li> <li>- 73h: Analog output</li> <li>- 74h: Analog input/-output</li> <li>- 76h: Counter</li> </ul> </li> <li>■ Bit 7: reserved</li> </ul>

**NUMBIT Diagnostic bits**

Byte	Bit 7 ... 0
0	Number of diagnostic bits per channel (here 08h)

**NUMCH Channels**

Byte	Bit 7 ... 0
0	Number of channels of a module (here 02h)

**CHERR Channel error**

Byte	Bit 7 ... 0
0	<ul style="list-style-type: none"> <li>■ Bit 0: set at error in channel group 0</li> <li>■ Bit 1: set at error in channel group 1</li> <li>■ Bit 7 ... 2: reserved</li> </ul>

**CH0ERR CH1ERR  
Channel-specific**

Byte	Bit 7 ... 0
0	Channel-specific error channel x: <ul style="list-style-type: none"> <li>■ Bit 0: set at configuring/parameter assignment error</li> <li>■ Bit 4 ... 1: reserved</li> <li>■ Bit 5: set at hardware interrupt lost</li> <li>■ Bit 6: set at measuring range underflow</li> <li>■ Bit 7: set at measuring range overflow</li> </ul>

**CH2ERR ... CH7ERR  
reserved**

Byte	Bit 7 ... 0
0	reserved

**DIAG\_US  $\mu$ s ticker**

Byte	Bit 7 ... 0
0...3	Value of the $\mu$ s ticker at the moment of the diagnostic

 **$\mu$ s ticker**

In the System SLIO module there is a timer ( $\mu$ s ticker). With PowerON the timer starts counting with 0. After  $2^{32}-1\mu$ s the timer starts with 0 again.

### 3.19 031-1CB70 - AI 2x16Bit ±10V

**Properties**

The electronic module has 2 inputs with parameterizable functions. The channels of the module are electrically isolated from the backplane bus. In addition, the channels are isolated to the DC 24V power supply by means of DC/DC converter.

- 2 analog inputs
- Suited for sensors with ±10V, 0 ... 10V
- Interrupt and diagnostics function
- Interference frequency suppression parameterizable (50/60Hz)
- 16bit resolution

**Structure**

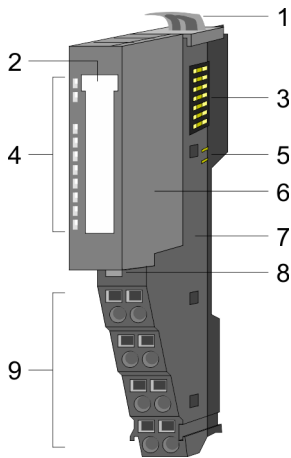

- 1 Locking lever terminal module
- 2 Labeling strip
- 3 Backplane bus
- 4 LED status indication
- 5 DC 24V power section supply
- 6 Electronic module
- 7 Terminal module
- 8 Locking lever electronic module
- 9 Terminal

**Status indication**

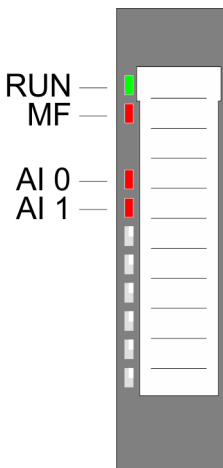

RUN	MF	AI x	Description
<input checked="" type="checkbox"/> green	<input checked="" type="checkbox"/> red	<input checked="" type="checkbox"/> red	
<input checked="" type="checkbox"/>	<input type="checkbox"/>	X	Bus communication is OK Module status is OK
<input checked="" type="checkbox"/>	<input checked="" type="checkbox"/>	X	Bus communication is OK Module status reports an error
<input type="checkbox"/>	<input checked="" type="checkbox"/>	X	Bus communication is not possible Module status reports an error
<input type="checkbox"/>	<input type="checkbox"/>	X	Error at bus power supply
X	<input checked="" type="checkbox"/>	X	Error in configuration → <a href="#">‘Trouble shooting - LEDs’...page 41</a>
<input checked="" type="checkbox"/>	<input type="checkbox"/>	<input checked="" type="checkbox"/>	Error channel x <ul style="list-style-type: none"> <li>■ Signal leaves measuring range</li> <li>■ Error in parameterization</li> </ul>
not relevant: X			

031-1CB70 - AI 2x16Bit ±10V

**Pin assignment**

For wires with a cross section of 0.08mm<sup>2</sup> up to 1.5mm<sup>2</sup>.

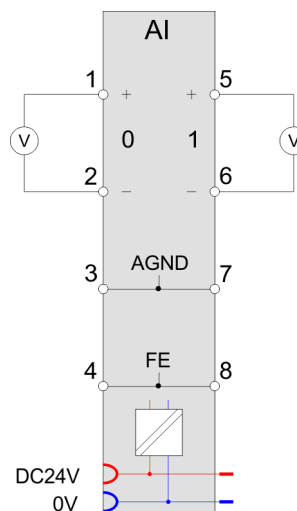
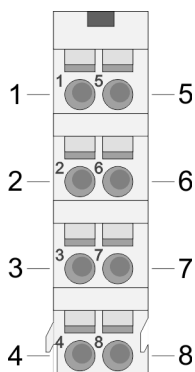

Pos.	Function	Type	Description
1	+AI 0	I	+ Channel 0
2	-AI 0	I	Ground Channel 0
3	AGND	I	Reference potential for differential-mode input
4	FE	I	Functional ground for cable shield (an additional shield bus carrier is not necessary)
5	+AI 1	I	+ Channel 1
6	-AI 1	I	Ground Channel 1
7	AGND	I	Reference potential for differential-mode input
8	FE	I	Functional ground for cable shield (an additional shield bus carrier is not necessary)

I: Input

**In-/Output area**

At CPU, PROFIBUS and PROFINET the input respectively output area is embedded to the corresponding address area.

IX Index for access via CANopen with s = Subindex, depends on number and type of analog modules

SX Subindex for access via EtherCAT with Index 6000h + EtherCAT-Slot

More can be found in the according manual of your bus coupler.

**Input area**

Addr.	Name	Bytes	Function	IX	SX
+0	AI 0	2	Analog value channel 0	6401h/s	01h
+2	AI 1	2	Analog value channel 1	6401h/s+1	02h

**Output area**

No byte of the output area is used by the module.



## 3.19.1 Technical data

Order no.	031-1CB70
Type	SM 031 - Analog input
Module ID	040C 1543
<b>Current consumption/power loss</b>	
Current consumption from backplane bus	60 mA
Power loss	0.8 W
<b>Technical data analog inputs</b>	
Number of inputs	2
Cable length, shielded	200 m
Rated load voltage	DC 24 V
Current consumption from load voltage L+ (without load)	20 mA
Voltage inputs	✓
Min. input resistance (voltage range)	200 k $\Omega$
Input voltage ranges	-10 V ... +10 V 0 V ... +10 V
Operational limit of voltage ranges	+/-0.2%
Operational limit of voltage ranges with SFU	-
Basic error limit voltage ranges	+/-0.1%
Basic error limit voltage ranges with SFU	-
Destruction limit voltage	max. 30V
Current inputs	-
Max. input resistance (current range)	-
Input current ranges	-
Operational limit of current ranges	-
Operational limit of current ranges with SFU	-
Basic error limit current ranges	-
Radical error limit current ranges with SFU	-
Destruction limit current inputs (voltage)	-
Destruction limit current inputs (electrical current)	-
Resistance inputs	-
Resistance ranges	-
Operational limit of resistor ranges	-
Operational limit of resistor ranges with SFU	-
Basic error limit	-
Basic error limit with SFU	-
Destruction limit resistance inputs	-
Resistance thermometer inputs	-
Resistance thermometer ranges	-

031-1CB70 - AI 2x16Bit  $\pm 10V$  > Technical data

Order no.	031-1CB70
Operational limit of resistance thermometer ranges	-
Operational limit of resistance thermometer ranges with SFU	-
Basic error limit thermoresistor ranges	-
Basic error limit thermoresistor ranges with SFU	-
Destruction limit resistance thermometer inputs	-
Thermocouple inputs	-
Thermocouple ranges	-
Operational limit of thermocouple ranges	-
Operational limit of thermocouple ranges with SFU	-
Basic error limit thermocouple ranges	-
Basic error limit thermocouple ranges with SFU	-
Destruction limit thermocouple inputs	-
Programmable temperature compensation	-
External temperature compensation	-
Internal temperature compensation	-
Temperature error internal compensation	-
Technical unit of temperature measurement	-
Resolution in bit	16
Measurement principle	successive approximation
Basic conversion time	240 $\mu$ s all channels
Noise suppression for frequency	>80dB at 50Hz (UCM<9V)
<b>Status information, alarms, diagnostics</b>	
Status display	yes
Interrupts	yes, parameterizable
Process alarm	yes, parameterizable
Diagnostic interrupt	yes, parameterizable
Diagnostic functions	yes
Diagnostics information read-out	possible
Module state	green LED
Module error display	red LED
Channel error display	red LED per channel
<b>Isolation</b>	
Between channels	-
Between channels of groups to	-
Between channels and backplane bus	✓
Between channels and power supply	✓
Max. potential difference between circuits	-

Order no.	031-1CB70
Max. potential difference between inputs (Ucm)	DC 9 V
Max. potential difference between Mana and Mintern (Uiso)	-
Max. potential difference between inputs and Mana (Ucm)	DC 1 V
Max. potential difference between inputs and Mintern (Uiso)	DC 75 V/ AC 50 V
Max. potential difference between Mintern and outputs	-
Insulation tested with	DC 500 V
<b>Technical data encoder supply</b>	
Number of outputs	-
Output voltage (typ)	-
Output voltage (rated value)	-
Short-circuit protection	-
Binding of potential	-
<b>Datasizes</b>	
Input bytes	4
Output bytes	0
Parameter bytes	20
Diagnostic bytes	20
<b>Housing</b>	
Material	PPE / PPE GF10
Mounting	Profile rail 35 mm
<b>Mechanical data</b>	
Dimensions (WxHxD)	12.9 mm x 109 mm x 76.5 mm
Net weight	61 g
Weight including accessories	61 g
Gross weight	75 g
<b>Environmental conditions</b>	
Operating temperature	0 °C to 60 °C
Storage temperature	-25 °C to 70 °C
<b>Certifications</b>	
UL certification	yes
KC certification	yes
UKCA certification	yes
ChinaRoHS certification	yes

SFU

Interference frequency suppression

## 3.19.2 Parameter data

DS Record set for access via CPU, PROFIBUS and PROFINET

IX Index for access via CANopen

SX Subindex for access via EtherCAT with Index 3100h + EtherCAT-Slot

More can be found in the according manual of your bus coupler.

Name	Bytes	Function	Default	DS	IX	SX
DIAG_EN	1	Diagnostics <sup>1</sup>	00h	00h	3100h	01h
RES1	1	reserved	00h	00h	3101h	02h
LIMIT_EN	1	Limit value monitoring <sup>1</sup>	00h	00h	3102h	03h
SUPR	1	Interference frequency suppression (SFU)	00h	01h	3103h	04h
CH0FN	1	Function number channel 0	12h	80h	3104h	05h
RES7	1	reserved	00h	80h	3105h	06h
CH0UL	2	Upper limit value channel 0	7FFFh	80h	3106h... 3107h	07h
CH0LL	2	Lower limit value channel 0	8000h	80h	3108h... 3109h	08h
CH1FN	1	Function number channel 1	12h	81h	310Ah	09h
RES13	1	reserved	00h	81h	310Bh	0Ah
CH1UL	2	Upper limit value channel 1	7FFFh	81h	310Ch... 310Dh	0Bh
CH1LL	2	Lower limit value channel 1	8000h	81h	310Eh... 310Fh	0Ch

1) This record set may only be transferred at STOP state.

#### DIAG\_EN Diagnostic interrupt

Byte	Bit 7 ... 0
0	<ul style="list-style-type: none"> <li>■ Diagnostic interrupt               <ul style="list-style-type: none"> <li>- 00h: disabled</li> <li>- 40h: enabled</li> </ul> </li> </ul>

■ Here you can enable respectively disable the diagnostic interrupt.

#### LIMIT\_EN Limit value monitoring

Byte	Bit 7 ... 0
0	<ul style="list-style-type: none"> <li>■ Bit 0: Limit value monitoring channel 0 (1: on)</li> <li>■ Bit 1: Limit value monitoring channel 1 (1: on)</li> <li>■ Bit 7 ... 2: reserved</li> </ul>

**SUPR Interference frequency suppression (SFU)**

Byte	Bit 7 ... 0
0	<ul style="list-style-type: none"> <li>■ Bit 1, 0: Interference frequency suppression channel 0                             <ul style="list-style-type: none"> <li>- 00: deactivated</li> <li>- 01: 60Hz</li> <li>- 10: 50Hz</li> </ul> </li> <li>■ Bit 3, 2: Interference frequency suppression channel 1                             <ul style="list-style-type: none"> <li>- 00: deactivated</li> <li>- 01: 60Hz</li> <li>- 10: 50Hz</li> </ul> </li> <li>■ Bit 7 ... 4: reserved</li> </ul>

**CHxFN Function number channel x**

In the following there are the measuring ranges with function number listed, which were supported by the analog module. With FFh the corresponding channel is deactivated. The formulas listed here allow you to transform an evaluated measuring value (digital value) to a value assigned to the measuring range (analog value) and vice versa.

Meas. range Voltage ±10V (funct. no.)	Voltage (U)	Decimal (D)	Hex	Range	Formulas
±10V Siemens S7 format (12h)	11.76V	32511	7EFFh	overrange	$D = 27648 \cdot \frac{U}{10}$ $U = D \cdot \frac{10}{27648}$
	10V	27648	6C00h	nominal range	
	5V	13824	3600h		
	0V	0	0000h		
	-5V	-13824	CA00h		
	-10V	-27648	9400h	underrange	
	-11.76V	-32512	8100h		
±10V Siemens S5 format (22h)	12.5V	20480	5000h	overrange	$D = 16384 \cdot \frac{U}{10}$ $U = D \cdot \frac{10}{16384}$
	10V	16384	4000h	nominal range	
	5V	8192	2000h		
	0V	0	0000h		
	-5V	-8192	E000h		
	-10V	-16384	C000h	underrange	
	-12.5V	-20480	B000h		

031-1CB70 - AI 2x16Bit ±10V &gt; Diagnostics and interrupt

Meas. range Voltage 0 ... 10V (funct. no.)	Voltage (U)	Decimal (D)	Hex	Range	Formulas
0 ... 10V Siemens S7 format (10h)	11.76V	32511	7EFFh	overrange	$D = 27648 \cdot \frac{U}{10}$ $U = D \cdot \frac{10}{27648}$
	10V	27648	6C00h	nominal range	
	5V	13824	3600h		
	0V	0	0000h		
	-1.76V	-4864	ED00h	underrange	
0 ... 10V Siemens S5 format (20h)	12.5V	20480	5000h	overrange	$D = 16384 \cdot \frac{U}{10}$ $U = D \cdot \frac{10}{16384}$
	10V	16384	4000h	nominal range	
	5V	8192	2000h		
	0V	0	0000h		
	-2V	-3277	F333h	underrange	

#### CHxUL / CHxLL Upper limit value Lower limit value channel x

For each channel an *upper* and a *lower limit* may be defined. Here only values of the nominal range may be preset, otherwise you receive a parameterization error. By presetting 7FFFh for the upper respectively 8000h for the lower limit value the corresponding limit is deactivated. As soon as the measuring value is beyond the limits and the limit value monitoring is activated, a hardware interrupt is initialized.

### 3.19.3 Diagnostics and interrupt

Event	Hardware interrupt	Diagnostics interrupt	parameterizable
Error in project engineering/parameterization	-	X	-
Measuring range overflow	-	X	-
Measuring range underflow	-	X	-
Limit overflow	X	-	X
Limit underflow	X	-	X
Diagnostic buffer overflow	-	X	-
Communication error	-	X	-
Hardware interrupt lost	-	X	-

#### Hardware interrupt

So you may react to asynchronous events, there is the possibility to activate a hardware interrupt.

- A hardware interrupt interrupts the linear program sequence and jumps depending on the master system to a corresponding Interrupt routine. Here you can react to the hardware interrupt accordingly.
- With CANopen the hardware interrupt data a transferred via an emergency telegram.
- Operating with CPU, PROFIBUS and PROFINET the hardware interrupt data were transferred via diagnostics telegram.

SX Subindex for access via EtherCAT with Index 5000h

More can be found in the according manual of your bus coupler.

Name	Bytes	Function	Default	SX
PRIT_OL	1	Upper limit overflow channel x	00h	02h
PRIT_UL	1	Lower limit underflow channel x	00h	03h
PRIT_US	2	µs-Ticker	00h	04h (high byte) 05h (low byte)

**PRIT\_OL Limit overflow**

Byte	Bit 7 ... 0
0	<ul style="list-style-type: none"> <li>■ Bit 0: Limit overflow channel 0</li> <li>■ Bit 1: Limit overflow channel 1</li> <li>■ Bit 7 ... 2: reserved</li> </ul>

**PRIT\_UL Limit underflow**

Byte	Bit 7 ... 0
0	<ul style="list-style-type: none"> <li>■ Bit 0: Limit underflow channel 0</li> <li>■ Bit 1: Limit underflow channel 1</li> <li>■ Bit 7 ... 2: reserved</li> </ul>

**PRIT\_US µs ticker**

Byte	Bit 7 ... 0
0 ... 1	Value of the µs ticker at the moment of the diagnostic.

**µs-ticker**

In the module there is a 32 bit timer (µs ticker). With PowerON the timer starts counting with 0. After  $2^{32}-1\mu\text{s}$  the timer starts with 0 again. PRIT\_US represents the lower 2 byte of the µs ticker value ( $0 \dots 2^{16}-1$ ).

**Diagnostic data**

Via the parametrization you may activate a diagnostic interrupt for the module. With a diagnostics interrupt the module serves for diagnostics data for diagnostic interrupt<sub>incoming</sub>. As soon as the reason for releasing a diagnostic interrupt is no longer present, the diagnostic interrupt<sub>going</sub> automatically takes place. All events of a channel between diagnostic interrupt<sub>incoming</sub> and diagnostic interrupt<sub>going</sub> are not stored and get lost. Within this time window (1. diagnostic interrupt<sub>incoming</sub> until last diagnostic interrupt<sub>going</sub>) the MF-LED of the module is on.

The following errors are listed in the diagnostics data:

- Error in project engineering / parameterization
- Measuring range overflow
- Measuring range underflow
- Hardware interrupt lost
- Power supply failed

DS Record set for access via CPU, PROFIBUS and PROFINET. The access happens by DS 01h. Additionally the first 4 bytes may be accessed by DS 00h.

IX Index for access via CANopen. The access happens by IX 2F01h. Additionally the first 4 bytes may be accessed by IX 2F00h.

SX Subindex for access via EtherCAT with Index 5005h.

More can be found in the according manual of your bus coupler.

031-1CB70 - AI 2x16Bit ±10V &gt; Diagnostics and interrupt

Name	Bytes	Function	Default	DS	IX	SX
ERR_A	1	Diagnostic	00h	01h	2F01h	02h
MODTYP	1	Module information	15h			03h
ERR_C	1	reserved	00h			04h
ERR_D	1	Diagnostic	00h			05h
CHTYP	1	Channel type	71h			06h
NUMBIT	1	Number diagnostic bits per channel	08h			07h
NUMCH	1	Number of channels of a module	02h			08h
CHERR	1	Channel error	00h			09h
CH0ERR	1	Channel-specific error channel 0	00h			0Ah
CH1ERR	1	Channel-specific error channel 1	00h			0Bh
CH2ERR... CH7ERR	6	reserved	00h			0Ch ... 11h
DIAG_US	4	µs ticker	00h			13h

**ERR\_A Diagnostic**

Byte	Bit 7 ... 0
0	<ul style="list-style-type: none"> <li>■ Bit 0: set at module failure</li> <li>■ Bit 1: set at internal error</li> <li>■ Bit 2: set at external error</li> <li>■ Bit 3: set at channel error</li> <li>■ Bit 4: set at external auxiliary supply missing</li> <li>■ Bit 6 ... 5: reserved</li> <li>■ Bit 7: set at error in parametrization</li> </ul>

**MODTYP  
Module information**

Byte	Bit 7 ... 0
0	<ul style="list-style-type: none"> <li>■ Bit 3 ... 0: module class <ul style="list-style-type: none"> <li>– 0101b analog module</li> </ul> </li> <li>■ Bit 4: set at channel information present</li> <li>■ Bit 7 ... 5: reserved</li> </ul>

**ERR\_D Diagnostic**

Byte	Bit 7 ... 0
0	<ul style="list-style-type: none"> <li>■ Bit 2 ... 0: reserved</li> <li>■ Bit 3: set at internal diagnostics buffer overflow</li> <li>■ Bit 4: set at internal communication error</li> <li>■ Bit 5: reserved</li> <li>■ Bit 6: set at hardware interrupt lost</li> <li>■ Bit 7: reserved</li> </ul>



**CHTYP Channel type**

Byte	Bit 7 ... 0
0	<ul style="list-style-type: none"> <li>■ Bit 6 ... 0: Channel type               <ul style="list-style-type: none"> <li>- 70h: Digital input</li> <li>- 71h: Analog input</li> <li>- 72h: Digital output</li> <li>- 73h: Analog output</li> <li>- 74h: Analog input/-output</li> <li>- 76h: Counter</li> </ul> </li> <li>■ Bit 7: reserved</li> </ul>

**NUMBIT Diagnostic bits**

Byte	Bit 7 ... 0
0	Number of diagnostic bits per channel (here 08h)

**NUMCH Channels**

Byte	Bit 7 ... 0
0	Number of channels of a module (here 02h)

**CHERR Channel error**

Byte	Bit 7 ... 0
0	<ul style="list-style-type: none"> <li>■ Bit 0: set at error in channel group 0</li> <li>■ Bit 1: set at error in channel group 1</li> <li>■ Bit 7 ... 2: reserved</li> </ul>

**CH0ERR/CH1ERR  
Channel-specific**

Byte	Bit 7 ... 0
0	Channel-specific error channel x: <ul style="list-style-type: none"> <li>■ Bit 0: set at configuring/parameter assignment error</li> <li>■ Bit 4 ... 1: reserved</li> <li>■ Bit 5: set at hardware interrupt lost</li> <li>■ Bit 6: set at measuring range underflow</li> <li>■ Bit 7: set at measuring range overflow</li> </ul>

**CH2ERR ... CH7ERR  
reserved**

Byte	Bit 7 ... 0
0	reserved

**DIAG\_US  $\mu$ s ticker**

Byte	Bit 7 ... 0
0...3	Value of the $\mu$ s ticker at the moment of the diagnostic

 **$\mu$ s ticker**

In the System SLIO module there is a timer ( $\mu$ s ticker). With PowerON the timer starts counting with 0. After  $2^{32}-1\mu$ s the timer starts with 0 again.

### 3.20 031-1CD30 - AI 4x16Bit 0...10V

#### Properties

The electronic module has 4 inputs with parameterizable functions. The channels of the module are electrically isolated from the backplane bus. In addition, the channels are isolated to the DC 24V power supply by means of DC/DC converter.

- 4 analog inputs
- Suited for sensors with 0 ... 10V
- Interrupt and diagnostics function
- Interference frequency suppression parameterizable (50/60Hz)
- 16bit resolution
- → '031-1CD35 - AI 4x16Bit 0...10V'...page 249 with limited parameter set

#### Structure

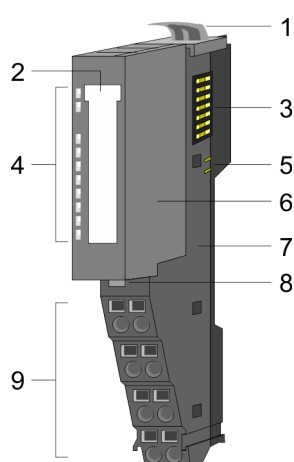

- 1 Locking lever terminal module
- 2 Labeling strip
- 3 Backplane bus
- 4 LED status indication
- 5 DC 24V power section supply
- 6 Electronic module
- 7 Terminal module
- 8 Locking lever electronic module
- 9 Terminal

#### Status indication

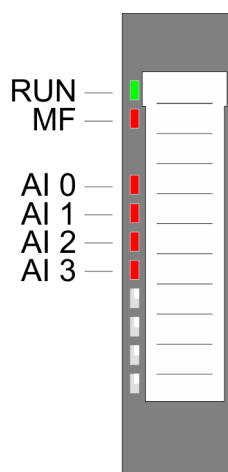

RUN	MF	AI x	Description
<input checked="" type="checkbox"/> green	<input checked="" type="checkbox"/> red	<input checked="" type="checkbox"/> red	
<input checked="" type="checkbox"/>	<input type="checkbox"/>	X	Bus communication is OK Module status is OK
<input checked="" type="checkbox"/>	<input checked="" type="checkbox"/>	X	Bus communication is OK Module status reports an error
<input type="checkbox"/>	<input checked="" type="checkbox"/>	X	Bus communication is not possible Module status reports an error
<input type="checkbox"/>	<input type="checkbox"/>	X	Error at bus power supply
X	<input checked="" type="checkbox"/>	X	Error in configuration → 'Trouble shooting - LEDs'...page 41
<input checked="" type="checkbox"/>	<input type="checkbox"/>	<input checked="" type="checkbox"/>	Error channel x <ul style="list-style-type: none"> <li>■ Signal leaves measuring range</li> <li>■ Error in parameterization</li> </ul>
not relevant: X			

**Pin assignment**

For wires with a cross section of 0.08mm<sup>2</sup> up to 1.5mm<sup>2</sup>.

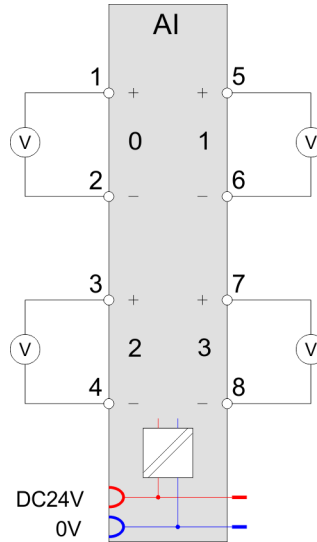
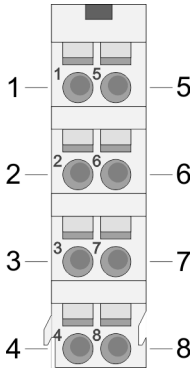

Pos.	Function	Type	Description
1	+AI 0	I	+ Channel 0
2	-AI 0	I	Ground Channel 0
3	+AI 2	I	+ Channel 2
4	-AI 2	I	Ground Channel 2
5	+AI 1	I	+ Channel 1
6	-AI 1	I	Ground Channel 1
7	+AI 3	I	+ Channel 3
8	-AI 3	I	Ground Channel 3

I: Input

**In-/Output area**

At CPU, PROFIBUS and PROFINET the input respectively output area is embedded to the corresponding address area.

IX Index for access via CANopen with s = Subindex, depends on number and type of analog modules

SX Subindex for access via EtherCAT with Index 6000h + EtherCAT-Slot

More can be found in the according manual of your bus coupler.

**Input area**

Addr.	Name	Bytes	Function	IX	SX
+0	AI 0	2	Analog value channel 0	6401h/s	01h
+2	AI 1	2	Analog value channel 1	6401h/s+1	02h
+4	AI 2	2	Analog value channel 2	6401h/s+2	03h
+6	AI 3	2	Analog value channel 3	6401h/s+3	04h

**Output area**

No byte of the output area is used by the module.

## 3.20.1 Technical data

Order no.	031-1CD30
Type	SM 031 - Analog input
Module ID	040D 1544
<b>Current consumption/power loss</b>	
Current consumption from backplane bus	65 mA
Power loss	0.9 W
<b>Technical data analog inputs</b>	
Number of inputs	4
Cable length, shielded	200 m
Rated load voltage	DC 24 V
Current consumption from load voltage L+ (without load)	25 mA
Voltage inputs	✓
Min. input resistance (voltage range)	200 kΩ
Input voltage ranges	0 V ... +10 V
Operational limit of voltage ranges	+/-0.2%
Operational limit of voltage ranges with SFU	-
Basic error limit voltage ranges	+/-0.1%
Basic error limit voltage ranges with SFU	-
Destruction limit voltage	max. 30V
Current inputs	-
Max. input resistance (current range)	-
Input current ranges	-
Operational limit of current ranges	-
Operational limit of current ranges with SFU	-
Basic error limit current ranges	-
Radical error limit current ranges with SFU	-
Destruction limit current inputs (voltage)	-
Destruction limit current inputs (electrical current)	-
Resistance inputs	-
Resistance ranges	-
Operational limit of resistor ranges	-
Operational limit of resistor ranges with SFU	-
Basic error limit	-
Basic error limit with SFU	-
Destruction limit resistance inputs	-
Resistance thermometer inputs	-
Resistance thermometer ranges	-
Operational limit of resistance thermometer ranges	-

Order no.	031-1CD30
Operational limit of resistance thermometer ranges with SFU	-
Basic error limit thermoresistor ranges	-
Basic error limit thermoresistor ranges with SFU	-
Destruction limit resistance thermometer inputs	-
Thermocouple inputs	-
Thermocouple ranges	-
Operational limit of thermocouple ranges	-
Operational limit of thermocouple ranges with SFU	-
Basic error limit thermocouple ranges	-
Basic error limit thermocouple ranges with SFU	-
Destruction limit thermocouple inputs	-
Programmable temperature compensation	-
External temperature compensation	-
Internal temperature compensation	-
Temperature error internal compensation	-
Technical unit of temperature measurement	-
Resolution in bit	16
Measurement principle	successive approximation
Basic conversion time	480 µs all channels
Noise suppression for frequency	>80dB at 50Hz (UCM<9V)
<b>Status information, alarms, diagnostics</b>	
Status display	yes
Interrupts	yes, parameterizable
Process alarm	yes, parameterizable
Diagnostic interrupt	yes, parameterizable
Diagnostic functions	yes
Diagnostics information read-out	possible
Module state	green LED
Module error display	red LED
Channel error display	red LED per channel
<b>Isolation</b>	
Between channels	-
Between channels of groups to	-
Between channels and backplane bus	✓
Between channels and power supply	✓
Max. potential difference between circuits	-
Max. potential difference between inputs (Ucm)	DC 9 V

031-1CD30 - AI 4x16Bit 0...10V &gt; Technical data

Order no.	031-1CD30
Max. potential difference between Mana and Mintern (Uiso)	-
Max. potential difference between inputs and Mana (Ucm)	-
Max. potential difference between inputs and Mintern (Uiso)	DC 75 V/ AC 50 V
Max. potential difference between Mintern and outputs	-
Insulation tested with	DC 500 V
<b>Technical data encoder supply</b>	
Number of outputs	-
Output voltage (typ)	-
Output voltage (rated value)	-
Short-circuit protection	-
Binding of potential	-
<b>Datasizes</b>	
Input bytes	8
Output bytes	0
Parameter bytes	32
Diagnostic bytes	20
<b>Housing</b>	
Material	PPE / PPE GF10
Mounting	Profile rail 35 mm
<b>Mechanical data</b>	
Dimensions (WxHxD)	12.9 mm x 109 mm x 76.5 mm
Net weight	61 g
Weight including accessories	61 g
Gross weight	75 g
<b>Environmental conditions</b>	
Operating temperature	0 °C to 60 °C
Storage temperature	-25 °C to 70 °C
<b>Certifications</b>	
UL certification	yes
KC certification	yes
UKCA certification	yes
ChinaRoHS certification	yes

SFU

Interference frequency suppression

## 3.20.2 Parameter data

DS Record set for access via CPU, PROFIBUS and PROFINET  
 IX Index for access via CANopen  
 SX Subindex for access via EtherCAT with Index 3100h + EtherCAT-Slot  
 More can be found in the according manual of your bus coupler.

Name	Bytes	Function	Default	DS	IX	SX
DIAG_EN	1	Diagnostics <sup>1</sup>	00h	00h	3100h	01h
RES1	1	reserved	00h	00h	3101h	02h
LIMIT_EN	1	Limit value monitoring <sup>1</sup>	00h	00h	3102h	03h
SUPR	1	Interference frequency suppression (SFU)	00h	01h	3103h	04h
CH0FN	1	Function number channel 0	10h	80h	3104h	05h
RES7	1	reserved	00h	80h	3105h	06h
CH0UL	2	Upper limit value channel 0	7FFFh	80h	3106h... 3107h	07h
CH0LL	2	Lower limit value channel 0	8000h	80h	3108h... 3109h	08h
CH1FN	1	Function number channel 1	10h	81h	310Ah	09h
RES13	1	reserved	00h	81h	310Bh	0Ah
CH1UL	2	Upper limit value channel 1	7FFFh	81h	310Ch... 310Dh	0Bh
CH1LL	2	Lower limit value channel 1	8000h	81h	310Eh... 310Fh	0Ch
CH2FN	1	Function number channel 2	10h	82h	3110h	0Dh
RES19	1	reserved	00h	82h	3111h	0Eh
CH2UL	2	Upper limit value channel 2	7FFFh	82h	3112h... 3113h	0Fh
CH2LL	2	Lower limit value channel 2	8000h	82h	3114h... 3115h	10h
CH3FN	1	Function number channel 3	10h	83h	3116h	11h
RES25	1	reserved	00h	83h	3117h	12h
CH3UL	2	Upper limit value channel 3	7FFFh	83h	3118h... 3119h	13h
CH3LL	2	Lower limit value channel 3	8000h	83h	311Ah... 311Bh	14h

1) This record set may only be transferred at STOP state.

**DIAG\_EN**  
Diagnostic interrupt

Byte	Bit 7 ... 0
0	<ul style="list-style-type: none"> <li>■ Diagnostic interrupt                             <ul style="list-style-type: none"> <li>- 00h: disabled</li> <li>- 40h: enabled</li> </ul> </li> </ul>

■ Here you can enable respectively disable the diagnostic interrupt.

**LIMIT\_EN**  
Limit value monitoring

Byte	Bit 7 ... 0
0	<ul style="list-style-type: none"> <li>■ Bit 0: Limit value monitoring channel 0 (1: on)</li> <li>■ Bit 1: Limit value monitoring channel 1 (1: on)</li> <li>■ Bit 2: Limit value monitoring channel 2 (1: on)</li> <li>■ Bit 3: Limit value monitoring channel 3 (1: on)</li> <li>■ Bit 7 ... 4: reserved</li> </ul>

**SUPR** Interference frequency suppression (SFU)

Byte	Bit 7 ... 0
0	<ul style="list-style-type: none"> <li>■ Bit 1, 0: Interference frequency suppression channel 0</li> <li>■ Bit 3, 2: Interference frequency suppression channel 1</li> <li>■ Bit 5, 4: Interference frequency suppression channel 2</li> <li>■ Bit 7, 6: Interference frequency suppression channel 3</li> <li>- 00: deactivated</li> <li>- 01: 60Hz</li> <li>- 10: 50Hz</li> </ul> <p>e.g.: 10101010: all channels frequency suppression 50Hz</p>

**CHxFN** Function number channel x

In the following there are the measuring ranges with corresponding function number listed, which were supported by the analog module. With FFh the corresponding channel is deactivated. The formulas listed here allow you to transform an evaluated measuring value (digital value) to a value assigned to the measuring range (analog value) and vice versa.

Meas. range Voltage 0 ... 10V (funct. no.)	Voltage (U)	Decimal (D)	Hex	Range	Formulas
0 ... 10V Siemens S7 format (10h)	11.76V	32511	7EFFh	overrange	$D = 27648 \cdot \frac{U}{10}$ $U = D \cdot \frac{10}{27648}$
	10V	27648	6C00h	nominal range	
	5V	13824	3600h		
	0V	0	0000h		
	-1.76V	-4864	ED00h	underrange	
0 ... 10V Siemens S5 format (20h)	12.5V	20480	5000h	overrange	$D = 16384 \cdot \frac{U}{10}$ $U = D \cdot \frac{10}{16384}$
	10V	16384	4000h	nominal range	
	5V	8192	2000h		
	0V	0	0000h		
	-2V	-3277	F333h	underrange	



**CHxUL CHxLL Upper limit value Lower limit value channel x**

For each channel an *upper* and a *lower limit* may be defined. Here only values of the nominal range may be preset, otherwise you receive a parameterization error. By presetting 7FFFh for the upper respectively 8000h for the lower limit value the corresponding limit is deactivated. As soon as the measuring value is beyond the limits and the limit value monitoring is activated, a hardware interrupt is initialized.

**3.20.3 Diagnostics and interrupt**

Event	Hardware interrupt	Diagnostics interrupt	parameterizable
Error in project engineering/parameterization	-	X	-
Measuring range overflow	-	X	-
Measuring range underflow	-	X	-
Limit overflow	X	-	X
Limit underflow	X	-	X
Diagnostic buffer overflow	-	X	-
Communication error	-	X	-
Hardware interrupt lost	-	X	-

**Hardware interrupt**

So you may react to asynchronous events, there is the possibility to activate a hardware interrupt.

- A hardware interrupt interrupts the linear program sequence and jumps depending on the master system to a corresponding Interrupt routine. Here you can react to the hardware interrupt accordingly.
- With CANopen the hardware interrupt data is transferred via an emergency telegram.
- Operating with CPU, PROFIBUS and PROFINET the hardware interrupt data were transferred via diagnostics telegram.

SX Subindex for access via EtherCAT with Index 5000h

More can be found in the according manual of your bus coupler.

Name	Bytes	Function	Default	SX
PRIT_OL	1	Upper limit overflow channel x	00h	02h
PRIT_UL	1	Lower limit underflow channel x	00h	03h
PRIT_US	2	µs-Ticker	00h	04h (high byte) 05h (low byte)

**PRIT\_OL Limit overflow**

Byte	Bit 7 ... 0
0	<ul style="list-style-type: none"> <li>■ Bit 0: Limit overflow channel 0</li> <li>■ Bit 1: Limit overflow channel 1</li> <li>■ Bit 2: Limit overflow channel 2</li> <li>■ Bit 3: Limit overflow channel 3</li> <li>■ Bit 7 ... 4: reserved</li> </ul>

**PRIT\_UL Limit underflow**

Byte	Bit 7 ... 0
0	<ul style="list-style-type: none"> <li>■ Bit 0: Limit underflow channel 0</li> <li>■ Bit 1: Limit underflow channel 1</li> <li>■ Bit 2: Limit underflow channel 2</li> <li>■ Bit 3: Limit underflow channel 3</li> <li>■ Bit 7 ... 4: reserved</li> </ul>

**PRIT\_US  $\mu$ s ticker**

Byte	Bit 7 ... 0
0 ... 1	Value of the $\mu$ s ticker at the moment of the diagnostic.

 **$\mu$ s ticker**

In the module there is a 32 bit timer ( $\mu$ s ticker). With PowerON the timer starts counting with 0. After  $2^{32}-1\mu$ s the timer starts with 0 again. PRIT\_US represents the lower 2 byte of the  $\mu$ s ticker value (0 ...  $2^{16}-1$ ).

**Diagnostic data**

Via the parametrization you may activate a diagnostic interrupt for the module. With a diagnostics interrupt the module serves for diagnostics data for diagnostic interrupt<sub>incoming</sub>. As soon as the reason for releasing a diagnostic interrupt is no longer present, the diagnostic interrupt<sub>going</sub> automatically takes place. All events of a channel between diagnostic interrupt<sub>incoming</sub> and diagnostic interrupt<sub>going</sub> are not stored and get lost. Within this time window (1. diagnostic interrupt<sub>incoming</sub> until last diagnostic interrupt<sub>going</sub>) the MF-LED of the module is on.

The following errors are listed in the diagnostics data:

- Error in project engineering / parameterization
- Measuring range overflow
- Measuring range underflow
- Hardware interrupt lost
- Power supply failed

DS Record set for access via CPU, PROFIBUS and PROFINET. The access happens by DS 01h. Additionally the first 4 bytes may be accessed by DS 00h.

IX Index for access via CANopen. The access happens by IX 2F01h. Additionally the first 4 bytes may be accessed by IX 2F00h.

SX Subindex for access via EtherCAT with Index 5005h.

More can be found in the according manual of your bus coupler.

Name	Bytes	Function	Default	DS	IX	SX
ERR_A	1	Diagnostic	00h	01h	2F01h	02h
MODTYP	1	Module information	15h			03h
ERR_C	1	reserved	00h			04h
ERR_D	1	Diagnostic	00h			05h
CHTYP	1	Channel type	71h			06h
NUMBIT	1	Number diagnostic bits per channel	08h			07h
NUMCH	1	Number of channels of a module	04h			08h
CHERR	1	Channel error	00h			09h
CH0ERR	1	Channel-specific error channel 0	00h			0Ah
CH1ERR	1	Channel-specific error channel 1	00h			0Bh
CH2ERR	1	Channel-specific error channel 2	00h			0Ch
CH3ERR	1	Channel-specific error channel 3	00h			0Dh
CH4ERR... CH7ERR	4	reserved	00h			0Eh ... 11h
DIAG_US	4	µs ticker	00h			13h

**ERR\_A Diagnostic**

Byte	Bit 7 ... 0
0	<ul style="list-style-type: none"> <li>■ Bit 0: set at module failure</li> <li>■ Bit 1: set at internal error</li> <li>■ Bit 2: set at external error</li> <li>■ Bit 3: set at channel error</li> <li>■ Bit 4: set at external auxiliary supply missing</li> <li>■ Bit 6 ... 5: reserved</li> <li>■ Bit 7: set at error in parametrization</li> </ul>

**MODTYP  
Module information**

Byte	Bit 7 ... 0
0	<ul style="list-style-type: none"> <li>■ Bit 3 ... 0: module class                             <ul style="list-style-type: none"> <li>– 0101b analog module</li> </ul> </li> <li>■ Bit 4: set at channel information present</li> <li>■ Bit 7 ... 5: reserved</li> </ul>

**ERR\_D Diagnostic**

Byte	Bit 7 ... 0
0	<ul style="list-style-type: none"> <li>■ Bit 2 ... 0: reserved</li> <li>■ Bit 3: set at internal diagnostics buffer overflow</li> <li>■ Bit 4: set at internal communication error</li> <li>■ Bit 5: reserved</li> <li>■ Bit 6: set at hardware interrupt lost</li> <li>■ Bit 7: reserved</li> </ul>

031-1CD30 - AI 4x16Bit 0...10V &gt; Diagnostics and interrupt

**CHTYP Channel type**

Byte	Bit 7 ... 0
0	<ul style="list-style-type: none"> <li>■ Bit 6 ... 0: Channel type               <ul style="list-style-type: none"> <li>- 70h: Digital input</li> <li>- 71h: Analog input</li> <li>- 72h: Digital output</li> <li>- 73h: Analog output</li> <li>- 74h: Analog input/-output</li> <li>- 76h: Counter</li> </ul> </li> <li>■ Bit 7: reserved</li> </ul>

**NUMBIT Diagnostic bits**

Byte	Bit 7 ... 0
0	Number of diagnostic bits per channel (here 08h)

**NUMCH Channels**

Byte	Bit 7 ... 0
0	Number of channels of a module (here 04h)

**CHERR Channel error**

Byte	Bit 7 ... 0
0	<ul style="list-style-type: none"> <li>■ Bit 0: set at error in channel group 0</li> <li>■ Bit 1: set at error in channel group 1</li> <li>■ Bit 2: set at error in channel group 2</li> <li>■ Bit 3: set at error in channel group 3</li> <li>■ Bit 7 ... 4: reserved</li> </ul>

**CH0ERR ... CH3ERR  
Channel-specific**

Byte	Bit 7 ... 0
0	Channel-specific error channel x: <ul style="list-style-type: none"> <li>■ Bit 0: set at configuring/parameter assignment error</li> <li>■ Bit 4 ... 1: reserved</li> <li>■ Bit 5: set at hardware interrupt lost</li> <li>■ Bit 6: set at measuring range underflow</li> <li>■ Bit 7: set at measuring range overflow</li> </ul>

**CH4ERR ... CH7ERR  
reserved**

Byte	Bit 7 ... 0
0	reserved

**DIAG\_US  $\mu$ s ticker**

Byte	Bit 7 ... 0
0...3	Value of the $\mu$ s ticker at the moment of the diagnostic

 **$\mu$ s ticker**

In the System SLIO module there is a timer ( $\mu$ s ticker). With PowerON the timer starts counting with 0. After  $2^{32}-1\mu$ s the timer starts with 0 again.

### 3.21 031-1CD35 - AI 4x16Bit 0...10V

#### Properties

The electronic module has 4 inputs with parameterizable functions. The channels of the module are electrically isolated from the backplane bus. In addition, the channels are isolated to the DC 24V power supply by means of DC/DC converter.

- 4 analog inputs
- Suited for sensors with 0 ... 10V
- Diagnostics function
- Interference frequency suppression parameterizable (50/60Hz)
- 16bit resolution
- [↪ '031-1CD30 - AI 4x16Bit 0...10V'...page 238](#)  
with extended parameter set

#### Structure

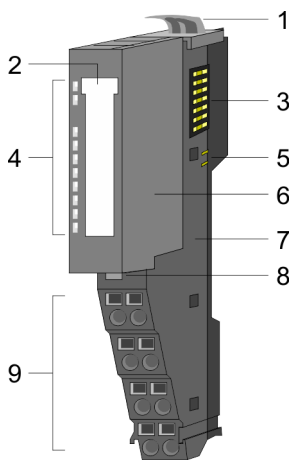

- 1 Locking lever terminal module
- 2 Labeling strip
- 3 Backplane bus
- 4 LED status indication
- 5 DC 24V power section supply
- 6 Electronic module
- 7 Terminal module
- 8 Locking lever electronic module
- 9 Terminal

#### Status indication

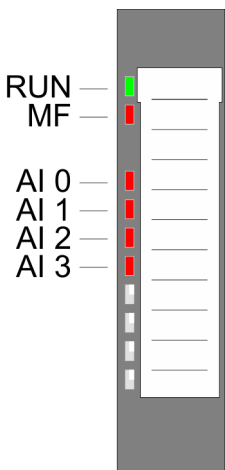

RUN	MF	AI x	Description
<input checked="" type="checkbox"/> green	<input checked="" type="checkbox"/> red	<input checked="" type="checkbox"/> red	
<input checked="" type="checkbox"/>	<input type="checkbox"/>	X	Bus communication is OK Module status is OK
<input checked="" type="checkbox"/>	<input checked="" type="checkbox"/>	X	Bus communication is OK Module status reports an error
<input type="checkbox"/>	<input checked="" type="checkbox"/>	X	Bus communication is not possible Module status reports an error
<input type="checkbox"/>	<input type="checkbox"/>	X	Error at bus power supply
X	<input checked="" type="checkbox"/>	X	Error in configuration <a href="#">↪ 'Trouble shooting - LEDs'...page 41</a>
<input checked="" type="checkbox"/>	<input type="checkbox"/>	<input checked="" type="checkbox"/>	Error channel x <ul style="list-style-type: none"> <li>■ Signal leaves measuring range</li> <li>■ Error in parameterization</li> </ul>
not relevant: X			

031-1CD35 - AI 4x16Bit 0...10V

**Pin assignment**

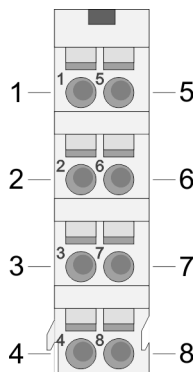

For wires with a cross section of 0.08mm<sup>2</sup> up to 1.5mm<sup>2</sup>.

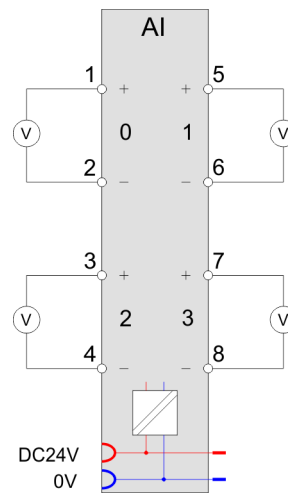

Pos.	Function	Type	Description
1	+AI 0	I	+ Channel 0
2	-AI 0	I	Ground Channel 0
3	+AI 2	I	+ Channel 2
4	-AI 2	I	Ground Channel 2
5	+AI 1	I	+ Channel 1
6	-AI 1	I	Ground Channel 1
7	+AI 3	I	+ Channel 3
8	-AI 3	I	Ground Channel 3

I: Input

**In-/Output area**

At CPU, PROFIBUS and PROFINET the input respectively output area is embedded to the corresponding address area.

IX Index for access via CANopen with s = Subindex, depends on number and type of analog modules

SX Subindex for access via EtherCAT with Index 6000h + EtherCAT-Slot

More can be found in the according manual of your bus coupler.

**Input area**

Addr.	Name	Bytes	Function	IX	SX
+0	AI 0	2	Analog value channel 0	6401h/s	01h
+2	AI 1	2	Analog value channel 1	6401h/s+1	02h
+4	AI 2	2	Analog value channel 2	6401h/s+2	03h
+6	AI 3	2	Analog value channel 3	6401h/s+3	04h

**Output area**

No byte of the output area is used by the module.

## 3.21.1 Technical data

Order no.	031-1CD35
Type	SM 031 - Analog input
Module ID	0413 15C4
<b>Current consumption/power loss</b>	
Current consumption from backplane bus	65 mA
Power loss	0.9 W
<b>Technical data analog inputs</b>	
Number of inputs	4
Cable length, shielded	200 m
Rated load voltage	DC 24 V
Current consumption from load voltage L+ (without load)	25 mA
Voltage inputs	✓
Min. input resistance (voltage range)	200 kΩ
Input voltage ranges	0 V ... +10 V
Operational limit of voltage ranges	+/-0.2%
Operational limit of voltage ranges with SFU	-
Basic error limit voltage ranges	+/-0.1%
Basic error limit voltage ranges with SFU	-
Destruction limit voltage	max. 30V
Current inputs	-
Max. input resistance (current range)	-
Input current ranges	-
Operational limit of current ranges	-
Operational limit of current ranges with SFU	-
Basic error limit current ranges	-
Radical error limit current ranges with SFU	-
Destruction limit current inputs (voltage)	-
Destruction limit current inputs (electrical current)	-
Resistance inputs	-
Resistance ranges	-
Operational limit of resistor ranges	-
Operational limit of resistor ranges with SFU	-
Basic error limit	-
Basic error limit with SFU	-
Destruction limit resistance inputs	-
Resistance thermometer inputs	-
Resistance thermometer ranges	-
Operational limit of resistance thermometer ranges	-

031-1CD35 - AI 4x16Bit 0...10V &gt; Technical data

Order no.	031-1CD35
Operational limit of resistance thermometer ranges with SFU	-
Basic error limit thermoresistor ranges	-
Basic error limit thermoresistor ranges with SFU	-
Destruction limit resistance thermometer inputs	-
Thermocouple inputs	-
Thermocouple ranges	-
Operational limit of thermocouple ranges	-
Operational limit of thermocouple ranges with SFU	-
Basic error limit thermocouple ranges	-
Basic error limit thermocouple ranges with SFU	-
Destruction limit thermocouple inputs	-
Programmable temperature compensation	-
External temperature compensation	-
Internal temperature compensation	-
Temperature error internal compensation	-
Technical unit of temperature measurement	-
Resolution in bit	16
Measurement principle	successive approximation
Basic conversion time	480 µs all channels
Noise suppression for frequency	>80dB at 50Hz (UCM<9V)
<b>Status information, alarms, diagnostics</b>	
Status display	yes
Interrupts	no
Process alarm	no
Diagnostic interrupt	no
Diagnostic functions	yes
Diagnostics information read-out	possible
Module state	green LED
Module error display	red LED
Channel error display	red LED per channel
<b>Isolation</b>	
Between channels	-
Between channels of groups to	-
Between channels and backplane bus	✓
Between channels and power supply	✓
Max. potential difference between circuits	-
Max. potential difference between inputs (Ucm)	DC 9 V



Order no.	031-1CD35
Max. potential difference between Mana and Mintern (Uiso)	-
Max. potential difference between inputs and Mana (Ucm)	-
Max. potential difference between inputs and Mintern (Uiso)	DC 75 V/ AC 50 V
Max. potential difference between Mintern and outputs	-
Insulation tested with	DC 500 V
<b>Technical data encoder supply</b>	
Number of outputs	-
Output voltage (typ)	-
Output voltage (rated value)	-
Short-circuit protection	-
Binding of potential	-
<b>Datasizes</b>	
Input bytes	8
Output bytes	0
Parameter bytes	9
Diagnostic bytes	20
<b>Housing</b>	
Material	PPE / PPE GF10
Mounting	Profile rail 35 mm
<b>Mechanical data</b>	
Dimensions (WxHxD)	12.9 mm x 109 mm x 76.5 mm
Net weight	61 g
Weight including accessories	61 g
Gross weight	75 g
<b>Environmental conditions</b>	
Operating temperature	0 °C to 60 °C
Storage temperature	-25 °C to 70 °C
<b>Certifications</b>	
UL certification	yes
KC certification	yes
UKCA certification	yes
ChinaRoHS certification	yes

SFU

Interference frequency suppression

### 3.21.2 Parameter data

- DS Record set for access via CPU, PROFIBUS and PROFINET  
 IX Index for access via CANopen  
 SX Subindex for access via EtherCAT with Index 3100h + EtherCAT-Slot  
 More can be found in the according manual of your bus coupler.

Name	Bytes	Function	Default	DS	IX	SX
SUPR	1	Interference frequency suppression	00h	01h	3100h	01h
CH0FN	1	Function number channel 0	10h	80h	3101h	02h
CH1FN	1	Function number channel 1	10h	81h	3102h	03h
CH2FN	1	Function number channel 2	10h	82h	3103h	04h
CH3FN	1	Function number channel 3	10h	83h	3104h	05h

#### SUPR Interference frequency suppression (SFU)

Byte	Bit 7 ... 0
0	<ul style="list-style-type: none"> <li>■ Bit 1, 0: Interference frequency suppression channel 0</li> <li>■ Bit 3, 2: Interference frequency suppression channel 1</li> <li>■ Bit 5, 4: Interference frequency suppression channel 2</li> <li>■ Bit 7, 6: Interference frequency suppression channel 3               <ul style="list-style-type: none"> <li>- 00: deactivated</li> <li>- 01: 60Hz</li> <li>- 10: 50Hz</li> </ul> </li> </ul> <p>e.g.: 10101010: all channels frequency suppression 50Hz</p>

#### CHxFN Function number channel x

In the following there are the measuring ranges with corresponding function number listed, which were supported by the analog module. With FFh the corresponding channel is deactivated. The formulas listed here allow you to transform an evaluated measuring value (digital value) to a value assigned to the measuring range (analog value) and vice versa.

Meas. range Voltage 0 ... 10V (funct. no.)	Voltage (U)	Decimal (D)	Hex	Range	Formulas
0 ... 10V Siemens S7 format (10h)	11.76V	32511	7EFFh	overrange	$D = 27648 \cdot \frac{U}{10}$ $U = D \cdot \frac{10}{27648}$
	10V	27648	6C00h	nominal range	
	5V	13824	3600h		
	0V	0	0000h		
	-1.76V	-4864	ED00h	underrange	
0 ... 10V Siemens S5 format (20h)	12.5V	20480	5000h	overrange	$D = 16384 \cdot \frac{U}{10}$ $U = D \cdot \frac{10}{16384}$
	10V	16384	4000h	nominal range	
	5V	8192	2000h		
	0V	0	0000h		
	-2V	-3277	F333h	underrange	

### 3.21.3 Diagnostic data

So this module does not support diagnostic interrupt functions, the diagnostics data serve for information about this module. On error the corresponding channel LED of the module is activated and the error is registered in the diagnostics data.

The following errors are listed in the diagnostics data:

- Error in project engineering / parameterization
- Measuring range overflow
- Measuring range underflow
- Power supply failed

DS Record set for access via CPU, PROFIBUS and PROFINET. The access happens by DS 01h. Additionally the first 4 bytes may be accessed by DS 00h.

IX Index for access via CANopen. The access happens by IX 2F01h. Additionally the first 4 bytes may be accessed by IX 2F00h.

SX Subindex for access via EtherCAT with Index 5005h.

More can be found in the according manual of your bus coupler.

031-1CD35 - AI 4x16Bit 0...10V &gt; Diagnostic data

Name	Bytes	Function	Default	DS	IX	SX
ERR_A	1	Diagnostic	00h	01h	2F01h	02h
MODTYP	1	Module information	15h			03h
ERR_C	1	reserved	00h			04h
ERR_D	1	Diagnostic	00h			05h
CHTYP	1	Channel type	71h			06h
NUMBIT	1	Number diagnostic bits per channel	08h			07h
NUMCH	1	Number of channels of a module	04h			08h
CHERR	1	Channel error	00h			09h
CH0ERR	1	Channel-specific error channel 0	00h			0Ah
CH1ERR	1	Channel-specific error channel 1	00h			0Bh
CH2ERR	1	Channel-specific error channel 2	00h			0Ch
CH3ERR	1	Channel-specific error channel 3	00h			0Dh
CH4ERR... CH7ERR	4	reserved	00h			0Eh ... 11h
DIAG_US	4	µs ticker	00h			13h

**ERR\_A Diagnostic**

Byte	Bit 7 ... 0
0	<ul style="list-style-type: none"> <li>■ Bit 0: set at module failure</li> <li>■ Bit 1: set at internal error</li> <li>■ Bit 2: set at external error</li> <li>■ Bit 3: set at channel error</li> <li>■ Bit 4: set at external auxiliary supply missing</li> <li>■ Bit 6 ... 5: reserved</li> <li>■ Bit 7: set at error in parametrization</li> </ul>

**MODTYP  
Module information**

Byte	Bit 7 ... 0
0	<ul style="list-style-type: none"> <li>■ Bit 3 ... 0: module class <ul style="list-style-type: none"> <li>- 0101b analog module</li> </ul> </li> <li>■ Bit 4: set at channel information present</li> <li>■ Bit 7 ... 5: reserved</li> </ul>

**CHTYP Channel type**

Byte	Bit 7 ... 0
0	<ul style="list-style-type: none"> <li>■ Bit 6 ... 0: Channel type <ul style="list-style-type: none"> <li>- 70h: Digital input</li> <li>- 71h: Analog input</li> <li>- 72h: Digital output</li> <li>- 73h: Analog output</li> <li>- 74h: Analog input/-output</li> <li>- 76h: Counter</li> </ul> </li> <li>■ Bit 7: reserved</li> </ul>

**NUMBIT Diagnostic bits**

Byte	Bit 7 ... 0
0	Number of diagnostic bits per channel (here 08h)

**NUMCH Channels**

Byte	Bit 7 ... 0
0	Number of channels of a module (here 04h)

**CHERR Channel error**

Byte	Bit 7 ... 0
0	<ul style="list-style-type: none"> <li>■ Bit 0: set at error in channel group 0</li> <li>■ Bit 1: set at error in channel group 1</li> <li>■ Bit 2: set at error in channel group 2</li> <li>■ Bit 3: set at error in channel group 3</li> <li>■ Bit 7 ... 4: reserved</li> </ul>

**CH0ERR ... CH3ERR  
Channel-specific**

Byte	Bit 7 ... 0
0	Channel-specific error channel x: <ul style="list-style-type: none"> <li>■ Bit 0: set at configuring/parameter assignment error</li> <li>■ Bit 5 ... 1: reserved</li> <li>■ Bit 6: set at measuring range underflow</li> <li>■ Bit 7: set at measuring range overflow</li> </ul>

**CH4ERR ... CH7ERR  
reserved**

Byte	Bit 7 ... 0
0	reserved

**DIAG\_US  $\mu$ s ticker**

Byte	Bit 7 ... 0
0...3	Value of the $\mu$ s ticker at the moment of the diagnostic

 **$\mu$ s ticker**

In the System SLIO module there is a timer ( $\mu$ s ticker). With PowerON the timer starts counting with 0. After  $2^{32}-1\mu$ s the timer starts with 0 again.

031-1CD40 - AI 4x16Bit 0(4)...20mA

### 3.22 031-1CD40 - AI 4x16Bit 0(4)...20mA

#### Properties

The electronic module has 4 inputs with parameterizable functions. The channels of the module are electrically isolated from the backplane bus. In addition, the channels are isolated to the DC 24V power supply by means of DC/DC converter.

- 4 analog inputs
- Suited for sensors with 0 ... 20mA;  
4 ... 20mA with external supply
- Interrupt and diagnostics function
- Interference frequency suppression parameterizable (50/60Hz)
- 16bit resolution
- → '031-1CD45 - AI 4x16Bit 0(4)...20mA'...page 270  
with limited parameter set

#### Structure

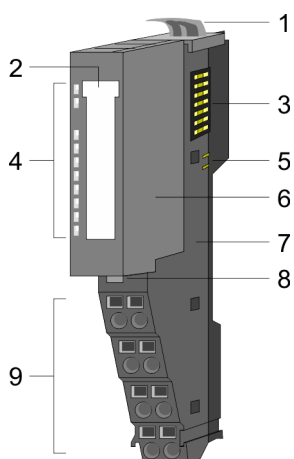

- 1 Locking lever terminal module
- 2 Labeling strip
- 3 Backplane bus
- 4 LED status indication
- 5 DC 24V power section supply
- 6 Electronic module
- 7 Terminal module
- 8 Locking lever electronic module
- 9 Terminal

#### Status indication

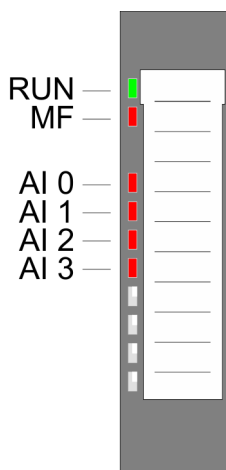

RUN ■ green	MF ■ red	AI x ■ red	Description
■	□	X	Bus communication is OK Module status is OK
■	■	X	Bus communication is OK Module status reports an error
□	■	X	Bus communication is not possible Module status reports an error
□	□	X	Error at bus power supply
X	■	X	Error in configuration → 'Trouble shooting - LEDs'...page 41
■	□	■	Error channel x <ul style="list-style-type: none"> <li>■ Signal leaves measuring range</li> <li>■ Error in parameterization</li> </ul>
not relevant: X			

Pin assignment

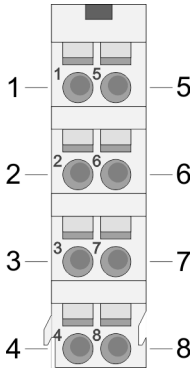

For wires with a cross section of 0.08mm<sup>2</sup> up to 1.5mm<sup>2</sup>.

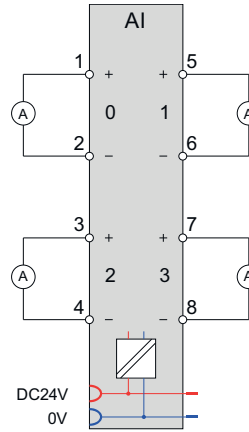

Pos.	Function	Type	Description
1	+AI 0	I	+ Channel 0
2	-AI 0	I	Ground Channel 0
3	+AI 2	I	+ Channel 2
4	-AI 2	I	Ground Channel 2
5	+AI 1	I	+ Channel 1
6	-AI 1	I	Ground Channel 1
7	+AI 3	I	+ Channel 3
8	-AI 3	I	Ground Channel 3

I: Input



*If a 2wire measuring transducer is used, you have to connect in line an external power supply.*

In-/Output area

At CPU, PROFIBUS and PROFINET the input respectively output area is embedded to the corresponding address area.

IX Index for access via CANopen with s = Subindex, depends on number and type of analog modules

SX Subindex for access via EtherCAT with Index 6000h + EtherCAT-Slot

More can be found in the according manual of your bus coupler.

Input area

Addr.	Name	Bytes	Function	IX	SX
+0	AI 0	2	Analog value channel 0	6401h/s	01h
+2	AI 1	2	Analog value channel 1	6401h/s+1	02h
+4	AI 2	2	Analog value channel 2	6401h/s+2	03h
+6	AI 3	2	Analog value channel 3	6401h/s+3	04h

Output area

No byte of the output area is used by the module.

## 3.22.1 Technical data

Order no.	031-1CD40
Type	SM 031 - Analog input
Module ID	0412 1544
<b>Current consumption/power loss</b>	
Current consumption from backplane bus	65 mA
Power loss	0.8 W
<b>Technical data analog inputs</b>	
Number of inputs	4
Cable length, shielded	200 m
Rated load voltage	DC 24 V
Current consumption from load voltage L+ (without load)	20 mA
Voltage inputs	-
Min. input resistance (voltage range)	-
Input voltage ranges	-
Operational limit of voltage ranges	-
Operational limit of voltage ranges with SFU	-
Basic error limit voltage ranges	-
Basic error limit voltage ranges with SFU	-
Destruction limit voltage	-
Current inputs	✓
Max. input resistance (current range)	60 Ω
Input current ranges	0 mA ... +20 mA +4 mA ... +20 mA
Operational limit of current ranges	+/-0.2%
Operational limit of current ranges with SFU	-
Basic error limit current ranges	+/-0.1%
Radical error limit current ranges with SFU	-
Destruction limit current inputs (voltage)	max. 24V
Destruction limit current inputs (electrical current)	max. 40mA
Resistance inputs	-
Resistance ranges	-
Operational limit of resistor ranges	-
Operational limit of resistor ranges with SFU	-
Basic error limit	-
Basic error limit with SFU	-
Destruction limit resistance inputs	-
Resistance thermometer inputs	-
Resistance thermometer ranges	-



Order no.	031-1CD40
Operational limit of resistance thermometer ranges	-
Operational limit of resistance thermometer ranges with SFU	-
Basic error limit thermoresistor ranges	-
Basic error limit thermoresistor ranges with SFU	-
Destruction limit resistance thermometer inputs	-
Thermocouple inputs	-
Thermocouple ranges	-
Operational limit of thermocouple ranges	-
Operational limit of thermocouple ranges with SFU	-
Basic error limit thermocouple ranges	-
Basic error limit thermocouple ranges with SFU	-
Destruction limit thermocouple inputs	-
Programmable temperature compensation	-
External temperature compensation	-
Internal temperature compensation	-
Temperature error internal compensation	-
Technical unit of temperature measurement	-
Resolution in bit	16
Measurement principle	successive approximation
Basic conversion time	480 µs all channels
Noise suppression for frequency	>80dB (UCM<4V)
<b>Status information, alarms, diagnostics</b>	
Status display	yes
Interrupts	yes, parameterizable
Process alarm	yes, parameterizable
Diagnostic interrupt	yes, parameterizable
Diagnostic functions	yes
Diagnostics information read-out	possible
Module state	green LED
Module error display	red LED
Channel error display	red LED per channel
<b>Isolation</b>	
Between channels	-
Between channels of groups to	-
Between channels and backplane bus	✓
Between channels and power supply	✓
Max. potential difference between circuits	-

031-1CD40 - AI 4x16Bit 0(4)...20mA &gt; Technical data

Order no.	031-1CD40
Max. potential difference between inputs (Ucm)	DC 4 V
Max. potential difference between Mana and Mintern (Uiso)	-
Max. potential difference between inputs and Mana (Ucm)	-
Max. potential difference between inputs and Mintern (Uiso)	DC 75 V/ AC 50 V
Max. potential difference between Mintern and outputs	-
Insulation tested with	DC 500 V
<b>Technical data encoder supply</b>	
Number of outputs	-
Output voltage (typ)	-
Output voltage (rated value)	-
Short-circuit protection	-
Binding of potential	-
<b>Datasizes</b>	
Input bytes	8
Output bytes	0
Parameter bytes	32
Diagnostic bytes	20
<b>Housing</b>	
Material	PPE / PPE GF10
Mounting	Profile rail 35 mm
<b>Mechanical data</b>	
Dimensions (WxHxD)	12.9 mm x 109 mm x 76.5 mm
Net weight	60 g
Weight including accessories	60 g
Gross weight	74 g
<b>Environmental conditions</b>	
Operating temperature	0 °C to 60 °C
Storage temperature	-25 °C to 70 °C
<b>Certifications</b>	
UL certification	yes
KC certification	yes
UKCA certification	yes
ChinaRoHS certification	yes

SFU

Interference frequency suppression

## 3.22.2 Parameter data

DS Record set for access via CPU, PROFIBUS and PROFINET

IX Index for access via CANopen

SX Subindex for access via EtherCAT with Index 3100h + EtherCAT-Slot

More can be found in the according manual of your bus coupler.

Name	Bytes	Function	Default	DS	IX	SX
DIAG_EN	1	Diagnostics <sup>1</sup>	00h	00h	3100h	01h
RES1	1	reserved	00h	00h	3101h	02h
LIMIT_EN	1	Limit value monitoring <sup>1</sup>	00h	00h	3102h	03h
SUPR	1	Interference frequency suppression (SFU)	00h	01h	3103h	04h
CH0FN	1	Function number channel 0	31h	80h	3104h	05h
RES7	1	reserved	00h	80h	3105h	06h
CH0UL	2	Upper limit value channel 0	7FFFh	80h	3106h... 3107h	07h
CH0LL	2	Lower limit value channel 0	8000h	80h	3108h... 3109h	08h
CH1FN	1	Function number channel 1	31h	81h	310Ah	09h
RES13	1	reserved	00h	81h	310Bh	0Ah
CH1UL	2	Upper limit value channel 1	7FFFh	81h	310Ch... 310Dh	0Bh
CH1LL	2	Lower limit value channel 1	8000h	81h	310Eh... 310Fh	0Ch
CH2FN	1	Function number channel 2	31h	82h	3110h	0Dh
RES19	1	reserved	00h	82h	3111h	0Eh
CH2UL	2	Upper limit value channel 2	7FFFh	82h	3112h... 3113h	0Fh
CH2LL	2	Lower limit value channel 2	8000h	82h	3114h... 3115h	10h
CH3FN	1	Function number channel 3	31h	83h	3116h	11h
RES25	1	reserved	00h	83h	3117h	12h
CH3UL	2	Upper limit value channel 3	7FFFh	83h	3118h... 3119h	13h
CH3LL	2	Lower limit value channel 3	8000h	83h	311Ah... 311Bh	14h

1) This record set may only be transferred at STOP state.

031-1CD40 - AI 4x16Bit 0(4)...20mA &gt; Parameter data

**DIAG\_EN**  
Diagnostic interrupt

Byte	Bit 7 ... 0
0	<ul style="list-style-type: none"> <li>■ Diagnostic interrupt               <ul style="list-style-type: none"> <li>- 00h: disabled</li> <li>- 40h: enabled</li> </ul> </li> </ul>

- Here you can enable respectively disable the diagnostic interrupt.

**LIMIT\_EN**  
Limit value monitoring

Byte	Bit 7 ... 0
0	<ul style="list-style-type: none"> <li>■ Bit 0: Limit value monitoring channel 0 (1: on)</li> <li>■ Bit 1: Limit value monitoring channel 1 (1: on)</li> <li>■ Bit 2: Limit value monitoring channel 2 (1: on)</li> <li>■ Bit 3: Limit value monitoring channel 3 (1: on)</li> <li>■ Bit 7 ... 4: reserved</li> </ul>

**SUPR Interference fre-**  
**quency suppression (SFU)**

Byte	Bit 7 ... 0
0	<ul style="list-style-type: none"> <li>■ Bit 1, 0: Interference frequency suppression channel 0</li> <li>■ Bit 3, 2: Interference frequency suppression channel 1</li> <li>■ Bit 5, 4: Interference frequency suppression channel 2</li> <li>■ Bit 7, 6: Interference frequency suppression channel 3               <ul style="list-style-type: none"> <li>- 00: deactivated</li> <li>- 01: 60Hz</li> <li>- 10: 50Hz</li> </ul> </li> </ul> <p>e.g.: 10101010: all channels frequency suppression 50Hz</p>

**CHxFN Function number**  
**channel x**

In the following there are the measuring ranges with corresponding function number listed, which were supported by the analog module. With FFh the corresponding channel is deactivated. The formulas listed here allow you to transform an evaluated measuring value (digital value) to a value assigned to the measuring range (analog value) and vice versa.

Meas. range Current 0(4) ... 20mA (funct. no.)	Current (I)	Decimal (D)	Hex	Range	Formulas
0 ... 20mA Siemens S7 format (31h)	23.52mA	32511	7EFFh	overrange	$D = 27648 \cdot \frac{I}{20}$ $I = D \cdot \frac{20}{27648}$
	20mA	27648	6C00h	nominal range	
	10mA	13824	3600h		
	0mA	0	0000h		
	-3.52mA	-4864	ED00h	underrange	
0 ... 20mA Siemens S5 format (41h)	25.00mA	20480	5000h	overrange	$D = 16384 \cdot \frac{I}{20}$ $I = D \cdot \frac{20}{16384}$
	20mA	16384	4000h	nominal range	
	10mA	8192	2000h		
	0mA	0	0000h		
	-4,00mA	-3277	F333h	underrange	
4 ... 20mA Siemens S7 format (30h)	22.81mA	32511	7EFFh	overrange	$D = 27648 \cdot \frac{I-4}{16}$ $I = D \cdot \frac{16}{27648} + 4$
	20mA	27648	6C00h	nominal range	
	12mA	13824	3600h		
	4mA	0	0000h		
	1.19mA	-4864	ED00h	underrange	
4 ... 20mA Siemens S5 format (40h)	24.00mA	20480	5000h	overrange	$D = 16384 \cdot \frac{I-4}{16}$ $I = D \cdot \frac{16}{16384} + 4$
	20mA	16384	4000h	nominal range	
	12mA	8192	2000h		
	4mA	0	0000h		
	0.8mA	-3277	F333h	underrange	

**CHxUL CHxLL Upper limit  
value Lower limit value  
channel x**

For each channel an *upper* and a *lower limit* may be defined. Here only values of the nominal range may be preset, otherwise you receive a parameterization error. By presetting 7FFFh for the upper respectively 8000h for the lower limit value the corresponding limit is deactivated. As soon as the measuring value is beyond the limits and the limit value monitoring is activated, a hardware interrupt is initialized.

### 3.22.3 Diagnostics and interrupt

Event	Hardware interrupt	Diagnostics interrupt	parameterizable
Error in project engineering/ parametrization	-	X	-
Measuring range overflow	-	X	-
Measuring range underflow	-	X	-
Limit overflow	X	-	X
Limit underflow	X	-	X
Diagnostic buffer overflow	-	X	-
Communication error	-	X	-
Hardware interrupt lost	-	X	-

#### Hardware interrupt

So you may react to asynchronous events, there is the possibility to activate a hardware interrupt.

- A hardware interrupt interrupts the linear program sequence and jumps depending on the master system to a corresponding Interrupt routine. Here you can react to the hardware interrupt accordingly.
- With CANopen the hardware interrupt data is transferred via an emergency telegram.
- Operating with CPU, PROFIBUS and PROFINET the hardware interrupt data were transferred via diagnostics telegram.

SX Subindex for access via EtherCAT with Index 5000h

More can be found in the according manual of your bus coupler.

Name	Bytes	Function	Default	SX
PRIT_OL	1	Upper limit overflow channel x	00h	02h
PRIT_UL	1	Lower limit underflow channel x	00h	03h
PRIT_US	2	µs-Ticker	00h	04h (high byte) 05h (low byte)

#### PRIT\_OL Limit overflow

Byte	Bit 7 ... 0
0	<ul style="list-style-type: none"> <li>■ Bit 0: Limit overflow channel 0</li> <li>■ Bit 1: Limit overflow channel 1</li> <li>■ Bit 2: Limit overflow channel 2</li> <li>■ Bit 3: Limit overflow channel 3</li> <li>■ Bit 7 ... 4: reserved</li> </ul>

#### PRIT\_UL Limit underflow

Byte	Bit 7 ... 0
0	<ul style="list-style-type: none"> <li>■ Bit 0: Limit underflow channel 0</li> <li>■ Bit 1: Limit underflow channel 1</li> <li>■ Bit 2: Limit underflow channel 2</li> <li>■ Bit 3: Limit underflow channel 3</li> <li>■ Bit 7 ... 4: reserved</li> </ul>

**PRIT\_US  $\mu$ s ticker**

Byte	Bit 7 ... 0
0 ... 1	Value of the $\mu$ s ticker at the moment of the diagnostic.

 **$\mu$ s ticker**

In the module there is a 32 bit timer ( $\mu$ s ticker). With PowerON the timer starts counting with 0. After  $2^{32}-1\mu$ s the timer starts with 0 again. PRIT\_US represents the lower 2 byte of the  $\mu$ s ticker value ( $0 \dots 2^{16}-1$ ).

**Diagnostic data**

Via the parametrization you may activate a diagnostic interrupt for the module. With a diagnostics interrupt the module serves for diagnostics data for diagnostic interrupt<sub>incoming</sub>. As soon as the reason for releasing a diagnostic interrupt is no longer present, the diagnostic interrupt<sub>going</sub> automatically takes place. All events of a channel between diagnostic interrupt<sub>incoming</sub> and diagnostic interrupt<sub>going</sub> are not stored and get lost. Within this time window (1. diagnostic interrupt<sub>incoming</sub> until last diagnostic interrupt<sub>going</sub>) the MF-LED of the module is on.

The following errors are listed in the diagnostics data:

- Error in project engineering / parameterization
- Measuring range overflow
- Measuring range underflow
- Hardware interrupt lost
- Power supply failed

DS Record set for access via CPU, PROFIBUS and PROFINET. The access happens by DS 01h. Additionally the first 4 bytes may be accessed by DS 00h.

IX Index for access via CANopen. The access happens by IX 2F01h. Additionally the first 4 bytes may be accessed by IX 2F00h.

SX Subindex for access via EtherCAT with Index 5005h.

More can be found in the according manual of your bus coupler.

031-1CD40 - AI 4x16Bit 0(4)...20mA &gt; Diagnostics and interrupt

Name	Bytes	Function	Default	DS	IX	SX
ERR_A	1	Diagnostic	00h	01h	2F01h	02h
MODTYP	1	Module information	15h			03h
ERR_C	1	reserved	00h			04h
ERR_D	1	Diagnostic	00h			05h
CHTYP	1	Channel type	71h			06h
NUMBIT	1	Number diagnostic bits per channel	08h			07h
NUMCH	1	Number of channels of a module	04h			08h
CHERR	1	Channel error	00h			09h
CH0ERR	1	Channel-specific error channel 0	00h			0Ah
CH1ERR	1	Channel-specific error channel 1	00h			0Bh
CH2ERR	1	Channel-specific error channel 2	00h			0Ch
CH3ERR	1	Channel-specific error channel 3	00h			0Dh
CH4ERR... CH7ERR	4	reserved	00h			0Eh ... 11h
DIAG_US	4	µs ticker	00h			13h

**ERR\_A Diagnostic**

Byte	Bit 7 ... 0
0	<ul style="list-style-type: none"> <li>■ Bit 0: set at module failure</li> <li>■ Bit 1: set at internal error</li> <li>■ Bit 2: set at external error</li> <li>■ Bit 3: set at channel error</li> <li>■ Bit 4: set at external auxiliary supply missing</li> <li>■ Bit 6 ... 5: reserved</li> <li>■ Bit 7: set at error in parametrization</li> </ul>

**MODTYP  
Module information**

Byte	Bit 7 ... 0
0	<ul style="list-style-type: none"> <li>■ Bit 3 ... 0: module class <ul style="list-style-type: none"> <li>– 0101b analog module</li> </ul> </li> <li>■ Bit 4: set at channel information present</li> <li>■ Bit 7 ... 5: reserved</li> </ul>

**ERR\_D Diagnostic**

Byte	Bit 7 ... 0
0	<ul style="list-style-type: none"> <li>■ Bit 2 ... 0: reserved</li> <li>■ Bit 3: set at internal diagnostics buffer overflow</li> <li>■ Bit 4: set at internal communication error</li> <li>■ Bit 5: reserved</li> <li>■ Bit 6: set at hardware interrupt lost</li> <li>■ Bit 7: reserved</li> </ul>



**CHTYP Channel type**

Byte	Bit 7 ... 0
0	<ul style="list-style-type: none"> <li>■ Bit 6 ... 0: Channel type               <ul style="list-style-type: none"> <li>- 70h: Digital input</li> <li>- 71h: Analog input</li> <li>- 72h: Digital output</li> <li>- 73h: Analog output</li> <li>- 74h: Analog input/-output</li> <li>- 76h: Counter</li> </ul> </li> <li>■ Bit 7: reserved</li> </ul>

**NUMBIT Diagnostic bits**

Byte	Bit 7 ... 0
0	Number of diagnostic bits per channel (here 08h)

**NUMCH Channels**

Byte	Bit 7 ... 0
0	Number of channels of a module (here 04h)

**CHERR Channel error**

Byte	Bit 7 ... 0
0	<ul style="list-style-type: none"> <li>■ Bit 0: set at error in channel group 0</li> <li>■ Bit 1: set at error in channel group 1</li> <li>■ Bit 2: set at error in channel group 2</li> <li>■ Bit 3: set at error in channel group 3</li> <li>■ Bit 7 ... 4: reserved</li> </ul>

**CH0ERR ... CH3ERR  
Channel-specific**

Byte	Bit 7 ... 0
0	Channel-specific error channel x: <ul style="list-style-type: none"> <li>■ Bit 0: set at configuring/parameter assignment error</li> <li>■ Bit 4 ... 1: reserved</li> <li>■ Bit 5: set at hardware interrupt lost</li> <li>■ Bit 6: set at measuring range underflow</li> <li>■ Bit 7: set at measuring range overflow</li> </ul>

**CH4ERR ... CH7ERR  
reserved**

Byte	Bit 7 ... 0
0	reserved

**DIAG\_US  $\mu$ s ticker**

Byte	Bit 7 ... 0
0...3	Value of the $\mu$ s ticker at the moment of the diagnostic

 **$\mu$ s ticker**

In the System SLIO module there is a timer ( $\mu$ s ticker). With PowerON the timer starts counting with 0. After  $2^{32}-1\mu$ s the timer starts with 0 again.

### 3.23 031-1CD45 - AI 4x16Bit 0(4)...20mA

#### Properties

The electronic module has 4 inputs with parameterizable functions. The channels of the module are electrically isolated from the backplane bus. In addition, the channels are isolated to the DC 24V power supply by means of DC/DC converter.

- 4 analog inputs
- Suited for sensors with 0 ... 20mA;  
4 ... 20mA with external supply
- Diagnostics function
- Interference frequency suppression parameterizable (50/60Hz)
- 16bit resolution
- → '031-1CD40 - AI 4x16Bit 0(4)...20mA'...page 258  
with extended parameter set

#### Structure

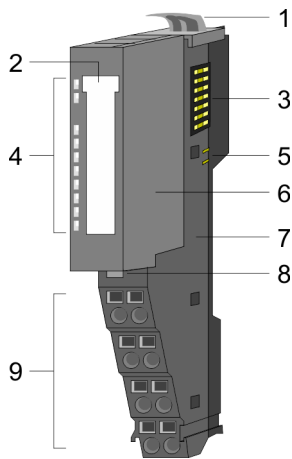

- 1 Locking lever terminal module
- 2 Labeling strip
- 3 Backplane bus
- 4 LED status indication
- 5 DC 24V power section supply
- 6 Electronic module
- 7 Terminal module
- 8 Locking lever electronic module
- 9 Terminal

#### Status indication

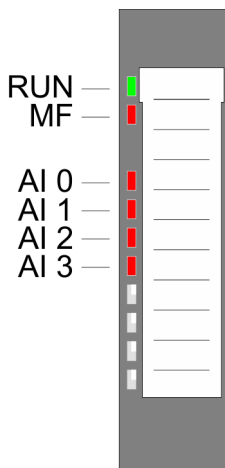

RUN green	MF red	AI x red	Description
■	□	X	Bus communication is OK Module status is OK
■	■	X	Bus communication is OK Module status reports an error
□	■	X	Bus communication is not possible Module status reports an error
□	□	X	Error at bus power supply
X	▣	X	Error in configuration → 'Trouble shooting - LEDs'...page 41
■	□	■	Error channel x <ul style="list-style-type: none"> <li>■ Signal leaves measuring range</li> <li>■ Error in parameterization</li> </ul>
not relevant: X			

**Pin assignment**

For wires with a cross section of 0.08mm<sup>2</sup> up to 1.5mm<sup>2</sup>.

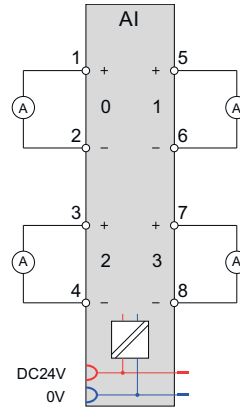
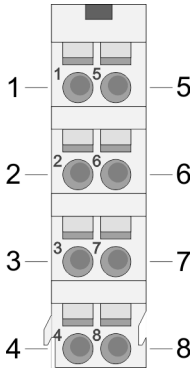

Pos.	Function	Type	Description
1	+AI 0	I	+ Channel 0
2	-AI 0	I	Ground Channel 0
3	+AI 2	I	+ Channel 2
4	-AI 2	I	Ground Channel 2
5	+AI 1	I	+ Channel 1
6	-AI 1	I	Ground Channel 1
7	+AI 3	I	+ Channel 3
8	-AI 3	I	Ground Channel 3

I: Input



*If a 2wire measuring transducer is used, you have to connect in line an external power supply.*

**In-/Output area**

At CPU, PROFIBUS and PROFINET the input respectively output area is embedded to the corresponding address area.

IX Index for access via CANopen with s = Subindex, depends on number and type of analog modules

SX Subindex for access via EtherCAT with Index 6000h + EtherCAT-Slot

More can be found in the according manual of your bus coupler.

**Input area**

Addr.	Name	Bytes	Function	IX	SX
+0	AI 0	2	Analog value channel 0	6401h/s	01h
+2	AI 1	2	Analog value channel 1	6401h/s+1	02h
+4	AI 2	2	Analog value channel 2	6401h/s+2	03h
+6	AI 3	2	Analog value channel 3	6401h/s+3	04h

**Output area**

No byte of the output area is used by the module.

## 3.23.1 Technical data

Order no.	031-1CD45
Type	SM 031 - Analog input
Module ID	0414 15C4
<b>Current consumption/power loss</b>	
Current consumption from backplane bus	65 mA
Power loss	0.8 W
<b>Technical data analog inputs</b>	
Number of inputs	4
Cable length, shielded	200 m
Rated load voltage	DC 24 V
Current consumption from load voltage L+ (without load)	20 mA
Voltage inputs	-
Min. input resistance (voltage range)	-
Input voltage ranges	-
Operational limit of voltage ranges	-
Operational limit of voltage ranges with SFU	-
Basic error limit voltage ranges	-
Basic error limit voltage ranges with SFU	-
Destruction limit voltage	-
Current inputs	✓
Max. input resistance (current range)	60 Ω
Input current ranges	0 mA ... +20 mA +4 mA ... +20 mA
Operational limit of current ranges	+/-0.2%
Operational limit of current ranges with SFU	-
Basic error limit current ranges	+/-0.1%
Radical error limit current ranges with SFU	-
Destruction limit current inputs (voltage)	max. 24V
Destruction limit current inputs (electrical current)	max. 40mA
Resistance inputs	-
Resistance ranges	-
Operational limit of resistor ranges	-
Operational limit of resistor ranges with SFU	-
Basic error limit	-
Basic error limit with SFU	-
Destruction limit resistance inputs	-
Resistance thermometer inputs	-
Resistance thermometer ranges	-

Order no.	031-1CD45
Operational limit of resistance thermometer ranges	-
Operational limit of resistance thermometer ranges with SFU	-
Basic error limit thermoresistor ranges	-
Basic error limit thermoresistor ranges with SFU	-
Destruction limit resistance thermometer inputs	-
Thermocouple inputs	-
Thermocouple ranges	-
Operational limit of thermocouple ranges	-
Operational limit of thermocouple ranges with SFU	-
Basic error limit thermocouple ranges	-
Basic error limit thermocouple ranges with SFU	-
Destruction limit thermocouple inputs	-
Programmable temperature compensation	-
External temperature compensation	-
Internal temperature compensation	-
Temperature error internal compensation	-
Technical unit of temperature measurement	-
Resolution in bit	16
Measurement principle	successive approximation
Basic conversion time	480 µs all channels
Noise suppression for frequency	>80dB (UCM<4V)
<b>Status information, alarms, diagnostics</b>	
Status display	yes
Interrupts	no
Process alarm	no
Diagnostic interrupt	no
Diagnostic functions	yes
Diagnostics information read-out	possible
Module state	green LED
Module error display	red LED
Channel error display	red LED per channel
<b>Isolation</b>	
Between channels	-
Between channels of groups to	-
Between channels and backplane bus	✓
Between channels and power supply	✓
Max. potential difference between circuits	-

031-1CD45 - AI 4x16Bit 0(4)...20mA &gt; Technical data

<b>Order no.</b>	<b>031-1CD45</b>
Max. potential difference between inputs (Ucm)	DC 4 V
Max. potential difference between Mana and Mintern (Uiso)	-
Max. potential difference between inputs and Mana (Ucm)	-
Max. potential difference between inputs and Mintern (Uiso)	DC 75 V/ AC 50 V
Max. potential difference between Mintern and outputs	-
Insulation tested with	DC 500 V
<b>Technical data encoder supply</b>	
Number of outputs	-
Output voltage (typ)	-
Output voltage (rated value)	-
Short-circuit protection	-
Binding of potential	-
<b>Datasizes</b>	
Input bytes	8
Output bytes	0
Parameter bytes	9
Diagnostic bytes	20
<b>Housing</b>	
Material	PPE / PPE GF10
Mounting	Profile rail 35 mm
<b>Mechanical data</b>	
Dimensions (WxHxD)	12.9 mm x 109 mm x 76.5 mm
Net weight	60 g
Weight including accessories	60 g
Gross weight	75 g
<b>Environmental conditions</b>	
Operating temperature	0 °C to 60 °C
Storage temperature	-25 °C to 70 °C
<b>Certifications</b>	
UL certification	yes
KC certification	yes
UKCA certification	yes
ChinaRoHS certification	yes

SFU

Interference frequency suppression

### 3.23.2 Parameter data

- DS Record set for access via CPU, PROFIBUS and PROFINET  
 IX Index for access via CANopen  
 SX Subindex for access via EtherCAT with Index 3100h + EtherCAT-Slot  
 More can be found in the according manual of your bus coupler.

Name	Bytes	Function	Default	DS	IX	SX
SUPR	1	Interference frequency suppression (SFU)	00h	01h	3100h	01h
CH0FN	1	Function number channel 0	31h	80h	3101h	02h
CH1FN	1	Function number channel 1	31h	81h	3102h	03h
CH2FN	1	Function number channel 2	31h	82h	3103h	04h
CH3FN	1	Function number channel 3	31h	83h	3104h	05h

#### SUPR Interference frequency suppression (SFU)

Byte	Bit 7 ... 0
0	<ul style="list-style-type: none"> <li>■ Bit 1, 0: Interference frequency suppression channel 0</li> <li>■ Bit 3, 2: Interference frequency suppression channel 1</li> <li>■ Bit 5, 4: Interference frequency suppression channel 2</li> <li>■ Bit 7, 6: Interference frequency suppression channel 3               <ul style="list-style-type: none"> <li>- 00: deactivated</li> <li>- 01: 60Hz</li> <li>- 10: 50Hz</li> </ul> </li> </ul> <p>e.g.: 10101010: all channels frequency suppression 50Hz</p>

#### CHxFN Function number channel x

In the following there are the measuring ranges with corresponding function number listed, which were supported by the analog module. With FFh the corresponding channel is deactivated. The formulas listed here allow you to transform an evaluated measuring value (digital value) to a value assigned to the measuring range (analog value) and vice versa.

031-1CD45 - AI 4x16Bit 0(4)...20mA &gt; Diagnostic data

Meas. range Current 0(4) ... 20mA (funct. no.)	Current (I)	Decimal (D)	Hex	Range	Formulas
0 ... 20mA Siemens S7 format (31h)	23.52mA	32511	7EFFh	overrange	$D = 27648 \cdot \frac{I}{20}$ $I = D \cdot \frac{20}{27648}$
	20mA	27648	6C00h	nominal range	
	10mA	13824	3600h		
	0mA	0	0000h		
	-3.52mA	-4864	ED00h	underrange	
0 ... 20mA Siemens S5 format (41h)	25.00mA	20480	5000h	overrange	$D = 16384 \cdot \frac{I}{20}$ $I = D \cdot \frac{20}{16384}$
	20mA	16384	4000h	nominal range	
	10mA	8192	2000h		
	0mA	0	0000h		
	-4,00mA	-3277	F333h	underrange	
4 ... 20mA Siemens S7 format (30h)	22.81mA	32511	7EFFh	overrange	$D = 27648 \cdot \frac{I-4}{16}$ $I = D \cdot \frac{16}{27648} + 4$
	20mA	27648	6C00h	nominal range	
	12mA	13824	3600h		
	4mA	0	0000h		
	1.19mA	-4864	ED00h	underrange	
4 ... 20mA Siemens S5 format (40h)	24.00mA	20480	5000h	overrange	$D = 16384 \cdot \frac{I-4}{16}$ $I = D \cdot \frac{16}{16384} + 4$
	20mA	16384	4000h	nominal range	
	12mA	8192	2000h		
	4mA	0	0000h		
	0.8mA	-3277	F333h	underrange	

### 3.23.3 Diagnostic data

So this module does not support diagnostic interrupt functions, the diagnostics data serve for information about this module. On error the corresponding channel LED of the module is activated and the error is registered in the diagnostics data.

The following errors are listed in the diagnostics data:

- Error in project engineering / parameterization
- Measuring range overflow
- Measuring range underflow
- Power supply failed

DS Record set for access via CPU, PROFIBUS and PROFINET. The access happens by DS 01h. Additionally the first 4 bytes may be accessed by DS 00h.

IX Index for access via CANopen. The access happens by IX 2F01h. Additionally the first 4 bytes may be accessed by IX 2F00h.

SX Subindex for access via EtherCAT with Index 5005h.

More can be found in the according manual of your bus coupler.



Name	Bytes	Function	Default	DS	IX	SX
ERR_A	1	Diagnostic	00h	01h	2F01h	02h
MODTYP	1	Module information	15h			03h
ERR_C	1	reserved	00h			04h
ERR_D	1	Diagnostic	00h			05h
CHTYP	1	Channel type	71h			06h
NUMBIT	1	Number diagnostic bits per channel	08h			07h
NUMCH	1	Number of channels of a module	04h			08h
CHERR	1	Channel error	00h			09h
CH0ERR	1	Channel-specific error channel 0	00h			0Ah
CH1ERR	1	Channel-specific error channel 1	00h			0Bh
CH2ERR	1	Channel-specific error channel 2	00h			0Ch
CH3ERR	1	Channel-specific error channel 3	00h			0Dh
CH4ERR... CH7ERR	4	reserved	00h			0Eh ... 11h
DIAG_US	4	µs ticker	00h			13h

**ERR\_A Diagnostic**

Byte	Bit 7 ... 0
0	<ul style="list-style-type: none"> <li>■ Bit 0: set at module failure</li> <li>■ Bit 1: set at internal error</li> <li>■ Bit 2: set at external error</li> <li>■ Bit 3: set at channel error</li> <li>■ Bit 4: set at external auxiliary supply missing</li> <li>■ Bit 6 ... 5: reserved</li> <li>■ Bit 7: set at error in parametrization</li> </ul>

**MODTYP  
Module information**

Byte	Bit 7 ... 0
0	<ul style="list-style-type: none"> <li>■ Bit 3 ... 0: module class <ul style="list-style-type: none"> <li>– 0101b analog module</li> </ul> </li> <li>■ Bit 4: set at channel information present</li> <li>■ Bit 7 ... 5: reserved</li> </ul>

**ERR\_D Diagnostic**

Byte	Bit 7 ... 0
0	<ul style="list-style-type: none"> <li>■ Bit 2 ... 0: reserved</li> <li>■ Bit 3: set at internal diagnostics buffer overflow</li> <li>■ Bit 4: set at internal communication error</li> <li>■ Bit 7 ... 5: reserved</li> </ul>

031-1CD45 - AI 4x16Bit 0(4)...20mA &gt; Diagnostic data

**CHTYP Channel type**

Byte	Bit 7 ... 0
0	<ul style="list-style-type: none"> <li>■ Bit 6 ... 0: Channel type               <ul style="list-style-type: none"> <li>- 70h: Digital input</li> <li>- 71h: Analog input</li> <li>- 72h: Digital output</li> <li>- 73h: Analog output</li> <li>- 74h: Analog input/-output</li> <li>- 76h: Counter</li> </ul> </li> <li>■ Bit 7: reserved</li> </ul>

**NUMBIT Diagnostic bits**

Byte	Bit 7 ... 0
0	Number of diagnostic bits per channel (here 08h)

**NUMCH Channels**

Byte	Bit 7 ... 0
0	Number of channels of a module (here 04h)

**CHERR Channel error**

Byte	Bit 7 ... 0
0	<ul style="list-style-type: none"> <li>■ Bit 0: set at error in channel group 0</li> <li>■ Bit 1: set at error in channel group 1</li> <li>■ Bit 2: set at error in channel group 2</li> <li>■ Bit 3: set at error in channel group 3</li> <li>■ Bit 7 ... 4: reserved</li> </ul>

**CH0ERR ... CH3ERR  
Channel-specific**

Byte	Bit 7 ... 0
0	Channel-specific error channel x: <ul style="list-style-type: none"> <li>■ Bit 0: set at configuring/parameter assignment error</li> <li>■ Bit 5 ... 1: reserved</li> <li>■ Bit 6: set at measuring range underflow</li> <li>■ Bit 7: set at measuring range overflow</li> </ul>

**CH4ERR ... CH7ERR  
reserved**

Byte	Bit 7 ... 0
0	reserved

**DIAG\_US  $\mu$ s ticker**

Byte	Bit 7 ... 0
0...3	Value of the $\mu$ s ticker at the moment of the diagnostic

 *$\mu$ s ticker*

In the System SLIO module there is a timer ( $\mu$ s ticker). With PowerON the timer starts counting with 0. After  $2^{32}-1\mu$ s the timer starts with 0 again.

### 3.24 031-1CD70 - AI 4x16Bit ±10V

**Properties**

The electronic module has 4 inputs with parameterizable functions. The channels of the module are electrically isolated from the backplane bus. In addition, the channels are isolated to the DC 24V power supply by means of DC/DC converter.

- 4 analog inputs
- Suited for sensors with ±10V, 0 ... 10V
- Interrupt and diagnostics function
- Interference frequency suppression parameterizable (50/60Hz)
- 16bit resolution

**Structure**

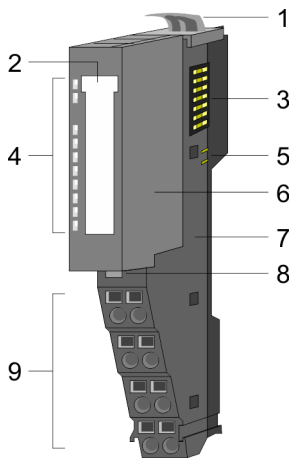

- 1 Locking lever terminal module
- 2 Labeling strip
- 3 Backplane bus
- 4 LED status indication
- 5 DC 24V power section supply
- 6 Electronic module
- 7 Terminal module
- 8 Locking lever electronic module
- 9 Terminal

**Status indication**

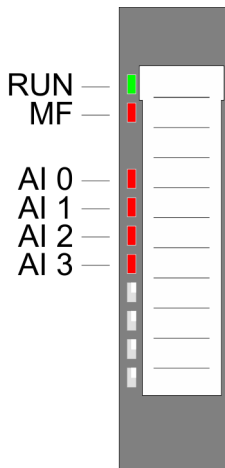

RUN	MF	AI x	Description
<input checked="" type="checkbox"/> green	<input checked="" type="checkbox"/> red	<input checked="" type="checkbox"/> red	
<input checked="" type="checkbox"/>	<input type="checkbox"/>	X	Bus communication is OK Module status is OK
<input checked="" type="checkbox"/>	<input checked="" type="checkbox"/>	X	Bus communication is OK Module status reports an error
<input type="checkbox"/>	<input checked="" type="checkbox"/>	X	Bus communication is not possible Module status reports an error
<input type="checkbox"/>	<input type="checkbox"/>	X	Error at bus power supply
X	<input checked="" type="checkbox"/>	X	Error in configuration → <a href="#">‘Trouble shooting - LEDs’...page 41</a>
<input checked="" type="checkbox"/>	<input type="checkbox"/>	<input checked="" type="checkbox"/>	Error channel x <ul style="list-style-type: none"> <li>■ Signal leaves measuring range</li> <li>■ Error in parameterization</li> </ul>
not relevant: X			

031-1CD70 - AI 4x16Bit ±10V

**Pin assignment**

For wires with a cross section of 0.08mm<sup>2</sup> up to 1.5mm<sup>2</sup>.

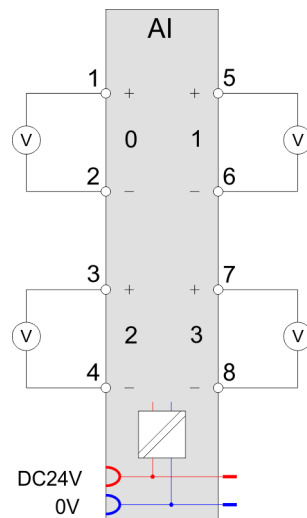
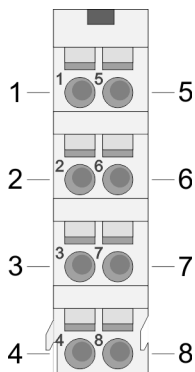

Pos.	Function	Type	Description
1	+AI 0	I	+ Channel 0
2	-AI 0	I	Ground Channel 0
3	+AI 2	I	+ Channel 2
4	-AI 2	I	Ground Channel 2
5	+AI 1	I	+ Channel 1
6	-AI 1	I	Ground Channel 1
7	+AI 3	I	+ Channel 3
8	-AI 3	I	Ground Channel 3

I: Input

**In-/Output area**

At CPU, PROFIBUS and PROFINET the input respectively output area is embedded to the corresponding address area.

IX Index for access via CANopen with s = Subindex, depends on number and type of analog modules

SX Subindex for access via EtherCAT with Index 6000h + EtherCAT-Slot

More can be found in the according manual of your bus coupler.

**Input area**

Addr.	Name	Bytes	Function	IX	SX
+0	AI 0	2	Analog value channel 0	6401h/s	01h
+2	AI 1	2	Analog value channel 1	6401h/s+1	02h
+4	AI 2	2	Analog value channel 2	6401h/s+2	03h
+6	AI 3	2	Analog value channel 3	6401h/s+3	04h

**Output area**

No byte of the output area is used by the module.

## 3.24.1 Technical data

Order no.	031-1CD70
Type	SM 031 - Analog input
Module ID	040E 1544
<b>Current consumption/power loss</b>	
Current consumption from backplane bus	65 mA
Power loss	0.9 W
<b>Technical data analog inputs</b>	
Number of inputs	4
Cable length, shielded	200 m
Rated load voltage	DC 24 V
Current consumption from load voltage L+ (without load)	25 mA
Voltage inputs	✓
Min. input resistance (voltage range)	200 k $\Omega$
Input voltage ranges	-10 V ... +10 V 0 V ... +10 V
Operational limit of voltage ranges	+/-0.2%
Operational limit of voltage ranges with SFU	-
Basic error limit voltage ranges	+/-0.1%
Basic error limit voltage ranges with SFU	-
Destruction limit voltage	max. 30V
Current inputs	-
Max. input resistance (current range)	-
Input current ranges	-
Operational limit of current ranges	-
Operational limit of current ranges with SFU	-
Basic error limit current ranges	-
Radical error limit current ranges with SFU	-
Destruction limit current inputs (voltage)	-
Destruction limit current inputs (electrical current)	-
Resistance inputs	-
Resistance ranges	-
Operational limit of resistor ranges	-
Operational limit of resistor ranges with SFU	-
Basic error limit	-
Basic error limit with SFU	-
Destruction limit resistance inputs	-
Resistance thermometer inputs	-
Resistance thermometer ranges	-

031-1CD70 - AI 4x16Bit  $\pm 10V$  > Technical data

Order no.	031-1CD70
Operational limit of resistance thermometer ranges	-
Operational limit of resistance thermometer ranges with SFU	-
Basic error limit thermoresistor ranges	-
Basic error limit thermoresistor ranges with SFU	-
Destruction limit resistance thermometer inputs	-
Thermocouple inputs	-
Thermocouple ranges	-
Operational limit of thermocouple ranges	-
Operational limit of thermocouple ranges with SFU	-
Basic error limit thermocouple ranges	-
Basic error limit thermocouple ranges with SFU	-
Destruction limit thermocouple inputs	-
Programmable temperature compensation	-
External temperature compensation	-
Internal temperature compensation	-
Temperature error internal compensation	-
Technical unit of temperature measurement	-
Resolution in bit	16
Measurement principle	successive approximation
Basic conversion time	480 $\mu$ s all channels
Noise suppression for frequency	>80dB at 50Hz (UCM<35V)
<b>Status information, alarms, diagnostics</b>	
Status display	yes
Interrupts	yes, parameterizable
Process alarm	yes, parameterizable
Diagnostic interrupt	yes, parameterizable
Diagnostic functions	yes
Diagnostics information read-out	possible
Module state	green LED
Module error display	red LED
Channel error display	red LED per channel
<b>Isolation</b>	
Between channels	-
Between channels of groups to	-
Between channels and backplane bus	✓
Between channels and power supply	✓
Max. potential difference between circuits	-

Order no.	031-1CD70
Max. potential difference between inputs (Ucm)	DC 9 V
Max. potential difference between Mana and Mintern (Uiso)	-
Max. potential difference between inputs and Mana (Ucm)	-
Max. potential difference between inputs and Mintern (Uiso)	DC 75 V/ AC 50 V
Max. potential difference between Mintern and outputs	-
Insulation tested with	DC 500 V
<b>Technical data encoder supply</b>	
Number of outputs	-
Output voltage (typ)	-
Output voltage (rated value)	-
Short-circuit protection	-
Binding of potential	-
<b>Datasizes</b>	
Input bytes	8
Output bytes	0
Parameter bytes	32
Diagnostic bytes	20
<b>Housing</b>	
Material	PPE / PPE GF10
Mounting	Profile rail 35 mm
<b>Mechanical data</b>	
Dimensions (WxHxD)	12.9 mm x 109 mm x 76.5 mm
Net weight	61 g
Weight including accessories	61 g
Gross weight	75 g
<b>Environmental conditions</b>	
Operating temperature	0 °C to 60 °C
Storage temperature	-25 °C to 70 °C
<b>Certifications</b>	
UL certification	yes
KC certification	yes
UKCA certification	yes
ChinaRoHS certification	yes

SFU

Interference frequency suppression

## 3.24.2 Parameter data

DS Record set for access via CPU, PROFIBUS and PROFINET

IX Index for access via CANopen

SX Subindex for access via EtherCAT with Index 3100h + EtherCAT-Slot

More can be found in the according manual of your bus coupler.

Name	Bytes	Function	Default	DS	IX	SX
DIAG_EN	1	Diagnostics <sup>1</sup>	00h	00h	3100h	01h
RES1	1	reserved	00h	00h	3101h	02h
LIMIT_EN	1	Limit value monitoring <sup>1</sup>	00h	00h	3102h	03h
SUPR	1	Interference frequency suppression (SFU)	00h	01h	3103h	04h
CH0FN	1	Function number channel 0	12h	80h	3104h	05h
RES7	1	reserved	00h	80h	3105h	06h
CH0UL	2	Upper limit value channel 0	7FFFh	80h	3106h... 3107h	07h
CH0LL	2	Lower limit value channel 0	8000h	80h	3108h... 3109h	08h
CH1FN	1	Function number channel 1	12h	81h	310Ah	09h
RES13	1	reserved	00h	81h	310Bh	0Ah
CH1UL	2	Upper limit value channel 1	7FFFh	81h	310Ch... 310Dh	0Bh
CH1LL	2	Lower limit value channel 1	8000h	81h	310Eh... 310Fh	0Ch
CH2FN	1	Function number channel 2	12h	82h	3110h	0Dh
RES19	1	reserved	00h	82h	3111h	0Eh
CH2UL	2	Upper limit value channel 2	7FFFh	82h	3112h... 3113h	0Fh
CH2LL	2	Lower limit value channel 2	8000h	82h	3114h... 3115h	10h
CH3FN	1	Function number channel 3	12h	83h	3116h	11h
RES25	1	reserved	00h	83h	3117h	12h
CH3UL	2	Upper limit value channel 3	7FFFh	83h	3118h... 3119h	13h
CH3LL	2	Lower limit value channel 3	8000h	83h	311Ah... 311Bh	14h

1) This record set may only be transferred at STOP state.



**DIAG\_EN**  
Diagnostic interrupt

Byte	Bit 7 ... 0
0	<ul style="list-style-type: none"> <li>■ Diagnostic interrupt               <ul style="list-style-type: none"> <li>- 00h: disabled</li> <li>- 40h: enabled</li> </ul> </li> </ul>

- Here you can enable respectively disable the diagnostic interrupt.

**LIMIT\_EN**  
Limit value monitoring

Byte	Bit 7 ... 0
0	<ul style="list-style-type: none"> <li>■ Bit 0: Limit value monitoring channel 0 (1: on)</li> <li>■ Bit 1: Limit value monitoring channel 1 (1: on)</li> <li>■ Bit 2: Limit value monitoring channel 2 (1: on)</li> <li>■ Bit 3: Limit value monitoring channel 3 (1: on)</li> <li>■ Bit 7 ... 4: reserved</li> </ul>

**SUPR Interference fre-**  
**quency suppression (SFU)**

Byte	Bit 7 ... 0
0	<ul style="list-style-type: none"> <li>■ Bit 1, 0: Interference frequency suppression channel 0</li> <li>■ Bit 3, 2: Interference frequency suppression channel 1</li> <li>■ Bit 5, 4: Interference frequency suppression channel 2</li> <li>■ Bit 7, 6: Interference frequency suppression channel 3               <ul style="list-style-type: none"> <li>- 00: deactivated</li> <li>- 01: 60Hz</li> <li>- 10: 50Hz</li> </ul> </li> </ul> <p>e.g.: 10101010: all channels frequency suppression 50Hz</p>

**CHxFN Function number**  
**channel x**

In the following there are the measuring ranges with corresponding function number listed, which were supported by the analog module. With FFh the corresponding channel is deactivated. The formulas listed here allow you to transform an evaluated measuring value (digital value) to a value assigned to the measuring range (analog value) and vice versa.

031-1CD70 - AI 4x16Bit ±10V &gt; Parameter data

Meas. range Voltage ±10V (funct. no.)	Voltage (U)	Decimal (D)	Hex	Range	Formulas
±10V Siemens S7 format (12h)	11.76V	32511	7EFFh	overrange	$D = 27648 \cdot \frac{U}{10}$ $U = D \cdot \frac{10}{27648}$
	10V	27648	6C00h	nominal range	
	5V	13824	3600h		
	0V	0	0000h		
	-5V	-13824	CA00h		
	-10V	-27648	9400h		
	-11.76V	-32512	8100h	underrange	
±10V Siemens S5 format (22h)	12.5V	20480	5000h	overrange	$D = 16384 \cdot \frac{U}{10}$ $U = D \cdot \frac{10}{16384}$
	10V	16384	4000h	nominal range	
	5V	8192	2000h		
	0V	0	0000h		
	-5V	-8192	E000h		
	-10V	-16384	C000h		
	-12.5V	-20480	B000h	underrange	

Meas. range Voltage 0 ... 10V (funct. no.)	Voltage (U)	Decimal (D)	Hex	Range	Formulas
0 ... 10V Siemens S7 format (10h)	11.76V	32511	7EFFh	overrange	$D = 27648 \cdot \frac{U}{10}$ $U = D \cdot \frac{10}{27648}$
	10V	27648	6C00h	nominal range	
	5V	13824	3600h		
	0V	0	0000h		
	-1.76V	-4864	ED00h	underrange	
0 ... 10V Siemens S5 format (20h)	12.5V	20480	5000h	overrange	$D = 16384 \cdot \frac{U}{10}$ $U = D \cdot \frac{10}{16384}$
	10V	16384	4000h	nominal range	
	5V	8192	2000h		
	0V	0	0000h		
	-2V	-3277	F333h	underrange	

#### CHxUL CHxLL Upper limit value Lower limit value channel x

For each channel an *upper* and a *lower limit* may be defined. Here only values of the nominal range may be preset, otherwise you receive a parameterization error. By presetting 7FFFh for the upper respectively 8000h for the lower limit value the corresponding limit is deactivated. As soon as the measuring value is beyond the limits and the limit value monitoring is activated, a hardware interrupt is initialized.

### 3.24.3 Diagnostics and interrupt

Event	Hardware interrupt	Diagnostics interrupt	parameterizable
Error in project engineering/ parametrization	-	X	-
Measuring range overflow	-	X	-
Measuring range underflow	-	X	-
Limit overflow	X	-	X
Limit underflow	X	-	X
Diagnostic buffer overflow	-	X	-
Communication error	-	X	-
Hardware interrupt lost	-	X	-

#### Hardware interrupt

So you may react to asynchronous events, there is the possibility to activate a hardware interrupt.

- A hardware interrupt interrupts the linear program sequence and jumps depending on the master system to a corresponding Interrupt routine. Here you can react to the hardware interrupt accordingly.
- With CANopen the hardware interrupt data a transferred via an emergency telegram.
- Operating with CPU, PROFIBUS and PROFINET the hardware interrupt data were transferred via diagnostics telegram.

SX Subindex for access via EtherCAT with Index 5000h

More can be found in the according manual of your bus coupler.

Name	Bytes	Function	Default	SX
PRIT_OL	1	Upper limit overflow channel x	00h	02h
PRIT_UL	1	Lower limit underflow channel x	00h	03h
PRIT_US	2	µs-Ticker	00h	04h (high byte) 05h (low byte)

#### PRIT\_OL Limit overflow

Byte	Bit 7 ... 0
0	<ul style="list-style-type: none"> <li>■ Bit 0: Limit overflow channel 0</li> <li>■ Bit 1: Limit overflow channel 1</li> <li>■ Bit 2: Limit overflow channel 2</li> <li>■ Bit 3: Limit overflow channel 3</li> <li>■ Bit 7 ... 4: reserved</li> </ul>

#### PRIT\_UL Limit underflow

Byte	Bit 7 ... 0
0	<ul style="list-style-type: none"> <li>■ Bit 0: Limit underflow channel 0</li> <li>■ Bit 1: Limit underflow channel 1</li> <li>■ Bit 2: Limit underflow channel 2</li> <li>■ Bit 3: Limit underflow channel 3</li> <li>■ Bit 7 ... 4: reserved</li> </ul>

031-1CD70 - AI 4x16Bit  $\pm 10V$  > Diagnostics and interrupt**PRIT\_US  $\mu s$  ticker**

Byte	Bit 7 ... 0
0 ... 1	Value of the $\mu s$ ticker at the moment of the diagnostic.

 **$\mu s$  ticker**

In the module there is a 32 bit timer ( $\mu s$  ticker). With PowerON the timer starts counting with 0. After  $2^{32}-1\mu s$  the timer starts with 0 again. PRIT\_US represents the lower 2 byte of the  $\mu s$  ticker value (0 ...  $2^{16}-1$ ).

**Diagnostic data**

Via the parametrization you may activate a diagnostic interrupt for the module. With a diagnostics interrupt the module serves for diagnostics data for diagnostic interrupt<sub>incoming</sub>. As soon as the reason for releasing a diagnostic interrupt is no longer present, the diagnostic interrupt<sub>going</sub> automatically takes place. All events of a channel between diagnostic interrupt<sub>incoming</sub> and diagnostic interrupt<sub>going</sub> are not stored and get lost. Within this time window (1. diagnostic interrupt<sub>incoming</sub> until last diagnostic interrupt<sub>going</sub>) the MF-LED of the module is on.

The following errors are listed in the diagnostics data:

- Error in project engineering / parameterization
- Measuring range overflow
- Measuring range underflow
- Hardware interrupt lost
- Power supply failed

DS Record set for access via CPU, PROFIBUS and PROFINET. The access happens by DS 01h. Additionally the first 4 bytes may be accessed by DS 00h.

IX Index for access via CANopen. The access happens by IX 2F01h. Additionally the first 4 bytes may be accessed by IX 2F00h.

SX Subindex for access via EtherCAT with Index 5005h.

More can be found in the according manual of your bus coupler.

Name	Bytes	Function	Default	DS	IX	SX
ERR_A	1	Diagnostic	00h	01h	2F01h	02h
MODTYP	1	Module information	15h			03h
ERR_C	1	reserved	00h			04h
ERR_D	1	Diagnostic	00h			05h
CHTYP	1	Channel type	71h			06h
NUMBIT	1	Number diagnostic bits per channel	08h			07h
NUMCH	1	Number of channels of a module	04h			08h
CHERR	1	Channel error	00h			09h
CH0ERR	1	Channel-specific error channel 0	00h			0Ah
CH1ERR	1	Channel-specific error channel 1	00h			0Bh
CH2ERR	1	Channel-specific error channel 2	00h			0Ch
CH3ERR	1	Channel-specific error channel 3	00h			0Dh
CH4ERR... CH7ERR	4	reserved	00h			0Eh ... 11h
DIAG_US	4	µs ticker	00h			13h

**ERR\_A Diagnostic**

Byte	Bit 7 ... 0
0	<ul style="list-style-type: none"> <li>■ Bit 0: set at module failure</li> <li>■ Bit 1: set at internal error</li> <li>■ Bit 2: set at external error</li> <li>■ Bit 3: set at channel error</li> <li>■ Bit 4: set at external auxiliary supply missing</li> <li>■ Bit 6 ... 5: reserved</li> <li>■ Bit 7: set at error in parametrization</li> </ul>

**MODTYP  
Module information**

Byte	Bit 7 ... 0
0	<ul style="list-style-type: none"> <li>■ Bit 3 ... 0: module class <ul style="list-style-type: none"> <li>– 0101b analog module</li> </ul> </li> <li>■ Bit 4: set at channel information present</li> <li>■ Bit 7 ... 5: reserved</li> </ul>

**ERR\_D Diagnostic**

Byte	Bit 7 ... 0
0	<ul style="list-style-type: none"> <li>■ Bit 2 ... 0: reserved</li> <li>■ Bit 3: set at internal diagnostics buffer overflow</li> <li>■ Bit 4: set at internal communication error</li> <li>■ Bit 5: reserved</li> <li>■ Bit 6: set at hardware interrupt lost</li> <li>■ Bit 7: reserved</li> </ul>

**CHTYP Channel type**

Byte	Bit 7 ... 0
0	<ul style="list-style-type: none"> <li>■ Bit 6 ... 0: Channel type               <ul style="list-style-type: none"> <li>- 70h: Digital input</li> <li>- 71h: Analog input</li> <li>- 72h: Digital output</li> <li>- 73h: Analog output</li> <li>- 74h: Analog input/-output</li> <li>- 76h: Counter</li> </ul> </li> <li>■ Bit 7: reserved</li> </ul>

**NUMBIT Diagnostic bits**

Byte	Bit 7 ... 0
0	Number of diagnostic bits per channel (here 08h)

**NUMCH Channels**

Byte	Bit 7 ... 0
0	Number of channels of a module (here 04h)

**CHERR Channel error**

Byte	Bit 7 ... 0
0	<ul style="list-style-type: none"> <li>■ Bit 0: set at error in channel group 0</li> <li>■ Bit 1: set at error in channel group 1</li> <li>■ Bit 2: set at error in channel group 2</li> <li>■ Bit 3: set at error in channel group 3</li> <li>■ Bit 7 ... 4: reserved</li> </ul>

**CH0ERR ... CH3ERR  
Channel-specific**

Byte	Bit 7 ... 0
0	Channel-specific error channel x: <ul style="list-style-type: none"> <li>■ Bit 0: set at configuring/parameter assignment error</li> <li>■ Bit 4 ... 1: reserved</li> <li>■ Bit 5: set at hardware interrupt lost</li> <li>■ Bit 6: set at measuring range underflow</li> <li>■ Bit 7: set at measuring range overflow</li> </ul>

**CH4ERR ... CH7ERR  
reserved**

Byte	Bit 7 ... 0
0	reserved

**DIAG\_US  $\mu$ s ticker**

Byte	Bit 7 ... 0
0...3	Value of the $\mu$ s ticker at the moment of the diagnostic

 *$\mu$ s ticker*

In the System SLIO module there is a timer ( $\mu$ s ticker). With PowerON the timer starts counting with 0. After  $2^{32}-1\mu$ s the timer starts with 0 again.

### 3.25 031-1CF90 - AI 8x16Bit TC

#### Properties

The electronic module has 8 inputs for temperature and voltage measuring with parametrizable functions. The channels of the module are isolated to the backplane bus.

- 8 analog inputs:
- Suited for sensors with type J, K, N, R, S, T, B, C, E, L and for voltage measuring  $\pm 80\text{mV}$
- Interrupt and diagnostics function
- 16bit resolution
- Smoothing function can be activated per channel during runtime
- Cold junction compensation can be activated per channel during runtime
- High potential difference between the inputs of DC75V / AC60V

#### Structure

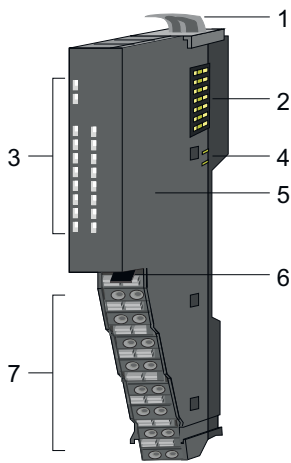

- 1 Locking lever module
- 2 Backplane bus
- 3 LED status indication
- 4 DC 24V power section supply
- 5 Electronic unit
- 6 Locking lever terminal block
- 7 Terminal block

#### Status indication

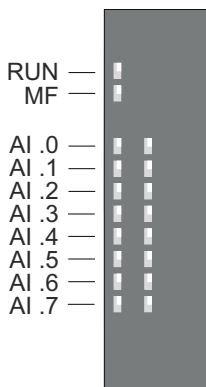

RUN	MF	AI x	Description
<input checked="" type="checkbox"/> green	<input checked="" type="checkbox"/> red	<input checked="" type="checkbox"/> red	
<input checked="" type="checkbox"/>	<input type="checkbox"/>	X	Bus communication is OK Module status is OK
<input checked="" type="checkbox"/>	<input checked="" type="checkbox"/>	X	Bus communication is OK Module status reports an error
<input type="checkbox"/>	<input checked="" type="checkbox"/>	X	Bus communication is not possible Module status reports an error
<input type="checkbox"/>	<input type="checkbox"/>	X	Error at bus power supply
X	<input checked="" type="checkbox"/>	X	Blinking: Error in configuration <a href="#">↪ 'Trouble shooting - LEDs'...page 41</a>
<input checked="" type="checkbox"/>	<input type="checkbox"/>	<input checked="" type="checkbox"/>	Error channel x <ul style="list-style-type: none"> <li>■ Signal leaves measuring range</li> <li>■ Error in parametrization</li> <li>■ Wire break (if parametrized)</li> </ul>
not relevant: X			

031-1CF90 - AI 8x16Bit TC

Pin assignment

For wires with a core cross-section of 0.14mm<sup>2</sup> up to 0.75mm<sup>2</sup>. With a core cross-section < 0.25mm<sup>2</sup>, ferrules must be used. → 'Data'...page 29

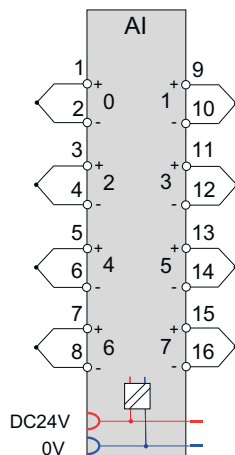
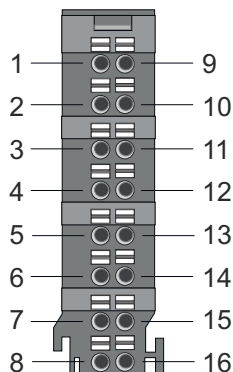

Pos.	Function	Type	Description
1	+TC 0	I	+ channel 0
2	-TC 0	I	Ground channel 0
3	+TC 2	I	+ channel 2
4	-TC 2	I	Ground channel 2
5	+TC 4	I	+ channel 4
6	-TC 4	I	Ground channel 4
7	+TC 6	I	+ channel 6
8	-TC 6	I	Ground channel 6
9	+TC 1	I	+ channel 1
10	-TC 1	I	Ground channel 1
11	+TC 3	I	+ channel 3
12	-TC 3	I	Ground channel 3
13	+TC 5	I	+ channel 5
14	-TC 5	I	Ground channel 5
15	+TC 7	I	+ channel 7
16	-TC 7	I	Ground channel 7

I: Input



*Please take care of the correct polarity when installing the sensors!  
Please install short circuits at non-used inputs by connecting the positive contact with the channel ground of the according channel.*

Supplementation to the installation guidelines

To avoid variations in temperature within the module, which may affect the accuracy of the measurement, you should consider the following points when assembling:



- Do not arrange the module directly apart from a power module with a high feeding current.
- Do not install the module at the end of a line.
- The module should be in a static condition, i.e. the temperature should be as constant as possible in the environment of your module (closed switchgear cabinet free from air draught).
- The accuracy is reached after approx. 30 minutes after entering the static condition.

**In-/Output area**

At CPU, PROFIBUS and PROFINET the input respectively output area is embedded to the corresponding address area.

IX Index for access via CANopen with s = Subindex, depends on number and type of analog modules

SX Subindex for access via EtherCAT with Index 6000h + EtherCAT-Slot

More can be found in the according manual of your bus coupler.

**Input area**

Addr.	Name	Bytes	Function	IX	SX
+0	AI 0	2	Analog value channel 0	6401h/s	01h
+2	AI 1	2	Analog value channel 1	6401h/s+1	02h
+4	AI 2	2	Analog value channel 2	6401h/s+2	03h
+6	AI 3	2	Analog value channel 3	6401h/s+3	04h
+8	AI 4	2	Analog value channel 4	6401h/s+4	05h
+10	AI 5	2	Analog value channel 5	6401h/s+5	06h
+12	AI 6	2	Analog value channel 6	6401h/s+6	07h
+14	AI 7	2	Analog value channel 7	6401h/s+7	08h

**Output area**

No byte of the output area is used by the module.

## 3.25.1 Technical data

Order no.	031-1CF90
Type	SM 031 - Analog input
Module ID	041B 1545
<b>Current consumption/power loss</b>	
Current consumption from backplane bus	80 mA
Power loss	0.5 W
<b>Technical data analog inputs</b>	
Number of inputs	8
Cable length, shielded	200 m
Rated load voltage	-
Current consumption from load voltage L+ (without load)	-
Voltage inputs	-
Min. input resistance (voltage range)	10 MΩ
Input voltage ranges	-80 mV ... +80 mV
Operational limit of voltage ranges	±0.3%
Operational limit of voltage ranges with SFU	±0.1%
Basic error limit voltage ranges	±0,15%
Basic error limit voltage ranges with SFU	±0.05%
Destruction limit voltage	max. 30V
Current inputs	-
Max. input resistance (current range)	-
Input current ranges	-
Operational limit of current ranges	-
Operational limit of current ranges with SFU	-
Basic error limit current ranges	-
Radical error limit current ranges with SFU	-
Destruction limit current inputs (voltage)	-
Destruction limit current inputs (electrical current)	-
Resistance inputs	-
Resistance ranges	-
Operational limit of resistor ranges	-
Operational limit of resistor ranges with SFU	-
Basic error limit	-
Basic error limit with SFU	-
Destruction limit resistance inputs	-
Resistance thermometer inputs	-
Resistance thermometer ranges	-
Operational limit of resistance thermometer ranges	-

Order no.	031-1CF90
Operational limit of resistance thermometer ranges with SFU	-
Basic error limit thermoresistor ranges	-
Basic error limit thermoresistor ranges with SFU	-
Destruction limit resistance thermometer inputs	-
Thermocouple inputs	✓
Thermocouple ranges	type B type C type E type J type K type L type N type R type S type T
Operational limit of thermocouple ranges	Type E, L, T, J, K, N: $\pm 2.5\text{K}$ / Type B, C, R, S: $\pm 8.0\text{K}$
Operational limit of thermocouple ranges with SFU	Type E, L, T, J, K, N: $\pm 1.5\text{K}$ / Type B, C, R, S: $\pm 4.0\text{K}$
Basic error limit thermocouple ranges	Type E, L, T, J, K, N: $\pm 2.0\text{K}$ / Type B, C, R, S: $\pm 7.0\text{K}$
Basic error limit thermocouple ranges with SFU	Type E, L, T, J, K, N: $\pm 1.0\text{K}$ / Type B, C, R, S: $\pm 3.0\text{K}$
Destruction limit thermocouple inputs	max. 30V
Programmable temperature compensation	✓
External temperature compensation	✓
Internal temperature compensation	✓
Temperature error internal compensation	1 K
Technical unit of temperature measurement	°C, °F, K
Resolution in bit	16
Measurement principle	Sigma-Delta
Basic conversion time	2.5 ms/16.7 ms/20 ms/100 ms per channel
Noise suppression for frequency	>90dB at 50Hz / 60Hz (UCM<10V)
<b>Status information, alarms, diagnostics</b>	
Status display	yes
Interrupts	yes
Process alarm	yes, parameterizable
Diagnostic interrupt	yes, parameterizable
Diagnostic functions	yes
Diagnostics information read-out	possible
Module state	green LED
Module error display	red LED

Order no.	031-1CF90
Channel error display	red LED per channel
<b>Isolation</b>	
Between channels	-
Between channels of groups to	-
Between channels and backplane bus	✓
Between channels and power supply	-
Max. potential difference between circuits	-
Max. potential difference between inputs (Ucm)	DC 75 V/ AC 50 V
Max. potential difference between Mana and Mintern (Uiso)	-
Max. potential difference between inputs and Mana (Ucm)	-
Max. potential difference between inputs and Mintern (Uiso)	DC 75 V/ AC 50 V
Max. potential difference between Mintern and outputs	-
Insulation tested with	DC 500 V
<b>Technical data encoder supply</b>	
Number of outputs	-
Output voltage (typ)	-
Output voltage (rated value)	-
Short-circuit protection	-
Binding of potential	-
<b>Datasizes</b>	
Input bytes	16
Output bytes	0
Parameter bytes	72
Diagnostic bytes	20
<b>Housing</b>	
Material	PC
Mounting	Profile rail 35 mm
<b>Mechanical data</b>	
Dimensions (WxHxD)	12.9 mm x 109 mm x 76.5 mm
Net weight	45 g
Weight including accessories	55 g
Gross weight	68 g
<b>Environmental conditions</b>	
Operating temperature	0 °C to 60 °C
Storage temperature	-40 °C to 70 °C
<b>Certifications</b>	

Order no.	031-1CF90
UL certification	yes
KC certification	in preparation
UKCA certification	yes
ChinaRoHS certification	yes

SFU Interference frequency suppression

The indicated error limits are valid starting from the following temperatures:

- Thermocouple type B: +600 °C
- Thermocouple type C: 0 °C
- Thermocouple type E: -200 °C
- Thermocouple type J: -210 °C
- Thermocouple type K: -200 °C
- Thermocouple type L: 0 °C
- Thermocouple type N: -200 °C
- Thermocouple type R: 0 °C
- Thermocouple type S: 0 °C
- Thermocouple type T: -200 °C

### 3.25.2 Parameter data

DS Record set for access via CPU, PROFIBUS and PROFINET

IX Index for access via CANopen

SX Subindex for access via EtherCAT with Index 3100h + EtherCAT-Slot

More can be found in the according manual of your bus coupler.

Name	Bytes	Function	Default	DS	IX	SX
DIAG_EN	1	Diagnostic interrupt <sup>1</sup>	00h	00h	3100h	01h
WIBRK_EN	1	Wire break recognition <sup>1</sup>	00h	00h	3101h	02h
LIMIT_EN	1	Limit value monitoring <sup>1</sup>	00h	00h	3102h	03h
RES3	1	reserved	00h	00h	3103h	04h
TEMPCNF	1	Temperature system	00h	01h	3104h	05h
RES5	1	reserved	00h	01h	3105h	06h
RES7	2	reserved	00FAh	01h	3106h... 3107h	07h
CH0FN	1	Function number channel 0	FFh	80h	3108h	08h
CH0FO	1	Function option channel 0	11h	80h	3109h	09h
CH0UL	2	Upper limit value channel 0	7FFFh	80h	310Ah...31 0Bh	0Ah
CH0LL	2	Lower limit value channel 0	8000h	80h	310Ch...31 0Dh	0Bh
CH1FN	1	Function number channel 1	FFh	81h	310Eh	0Ch
CH1FO	1	Function option channel 1	11h	81h	310Fh	0Dh

031-1CF90 - AI 8x16Bit TC &gt; Parameter data

Name	Bytes	Function	Default	DS	IX	SX
CH1UL	2	Upper limit value channel 1	7FFFh	81h	3110h... 3111h	0Eh
CH1LL	2	Lower limit value channel 1	8000h	81h	3112h... 3113h	0Fh
CH2FN	1	Function number channel 2	FFh	82h	3114h	10h
CH2FO	1	Function option channel 2	11h	82h	3115h	11h
CH2UL	2	Upper limit value channel 2	7FFFh	82h	3116h... 3117h	12h
CH2LL	2	Lower limit value channel 2	8000h	82h	3118h... 3119h	13h
CH3FN	1	Function number channel 3	FFh	83h	311Ah	14h
CH3FO	1	Function option channel 3	11h	83h	311Bh	15h
CH3UL	2	Upper limit value channel 3	7FFFh	83h	311Ch... 311Dh	16h
CH3LL	2	Lower limit value channel 3	8000h	83h	311Eh... 311Fh	17h
CH4FN	1	Function number channel 4	FFh	84h	3120h	18h
CH4FO	1	Function option channel 4	11h	84h	3121h	19h
CH4UL	2	Upper limit value channel 4	7FFFh	84h	3122h... 3123h	1Ah
CH4LL	2	Lower limit value channel 4	8000h	84h	3124h... 3125h	1Bh
CH5FN	1	Function number channel 5	FFh	85h	3126h	1Ch
CH5FO	1	Function option channel 5	11h	85h	3127h	1Dh
CH5UL	2	Upper limit value channel 5	7FFFh	85h	3128h... 3129h	1Eh
CH5LL	2	Lower limit value channel 5	8000h	85h	312Ah... 312Bh	1Fh
CH6FN	1	Function number channel 6	FFh	86h	312Ch	20h
CH6FO	1	Function option channel 6	11h	86h	312Dh	21h
CH6UL	2	Upper limit value channel 6	7FFFh	86h	312Eh... 312Fh	22h
CH6LL	2	Lower limit value channel 6	8000h	86h	3130h... 3131h	23h
CH7FN	1	Function number channel 7	FFh	87h	3132h	24h
CH7FO	1	Function option channel 7	11h	87h	3133h	25h
CH7UL	2	Upper limit value channel 7	7FFFh	87h	3134h... 3135h	26h
CH7LL	2	Lower limit value channel 7	8000h	87h	3136h... 3137h	27h
CH0CJT	2	Cold junction temperature channel 0	0000h	88h	3138h... 3139h	28h
CH1CJT	2	Cold junction temperature channel 1	0000h	88h	313Ah... 313Bh	29h

Name	Bytes	Function	Default	DS	IX	SX
CH2CJT	2	Cold junction temperature channel 2	0000h	88h	313Ch... 313Dh	2Ah
CH3CJT	2	Cold junction temperature channel 3	0000h	88h	313Eh... 313Fh	2Bh
CH4CJT	2	Cold junction temperature channel 4	0000h	88h	3140h... 3141h	2Ch
CH5CJT	2	Cold junction temperature channel 5	0000h	88h	3142h... 3143h	2Dh
CH6CJT	2	Cold junction temperature channel 6	0000h	88h	3144h... 3145h	2Eh
CH7CJT	2	Cold junction temperature channel 7	0000h	88h	3146h... 3147h	2Fh

1) This record set may only be transferred at STOP state.

### DIAG\_EN Diagnostic interrupt

Byte	Bit 7 ... 0
0	<ul style="list-style-type: none"> <li>■ Diagnostic interrupt               <ul style="list-style-type: none"> <li>- 00h: disabled</li> <li>- 40h: enabled</li> </ul> </li> </ul>

- Here you can enable respectively disable the diagnostic interrupt.

### WIBRK\_EN Wire break recognition

Byte	Bit 7 ... 0
0	<ul style="list-style-type: none"> <li>■ Bit 0: Wire break recognition channel 0 (1: on)</li> <li>■ Bit 1: Wire break recognition channel 1 (1: on)</li> <li>■ Bit 2: Wire break recognition channel 2 (1: on)</li> <li>■ Bit 3: Wire break recognition channel 3 (1: on)</li> <li>■ Bit 4: Wire break recognition channel 4 (1: on)</li> <li>■ Bit 5: Wire break recognition channel 5 (1: on)</li> <li>■ Bit 6: Wire break recognition channel 6 (1: on)</li> <li>■ Bit 7: Wire break recognition channel 7 (1: on)</li> </ul>



*Due to the high sensitivity of the inputs, unused inputs should be deactivated in the parametrization. Due to the high input impedance, open inputs can be influenced by adjacent channels or due to the measuring method during wire break detection. Since the entire measuring range moves in the mV range, open-loop inputs can already cause measuring range overshoots.*

**LIMIT\_EN**  
 Limit value monitoring

Byte	Bit 7 ... 0
0	<ul style="list-style-type: none"> <li>■ Bit 0: Limit value monitoring channel 0 (1: on)</li> <li>■ Bit 1: Limit value monitoring channel 1 (1: on)</li> <li>■ Bit 2: Limit value monitoring channel 2 (1: on)</li> <li>■ Bit 3: Limit value monitoring channel 3 (1: on)</li> <li>■ Bit 4: Limit value monitoring channel 4 (1: on)</li> <li>■ Bit 5: Limit value monitoring channel 5 (1: on)</li> <li>■ Bit 6: Limit value monitoring channel 6 (1: on)</li> <li>■ Bit 7: Limit value monitoring channel 7 (1: on)</li> </ul>

**TEMPCNF**  
 Temperature system

Byte	Bit 7 ... 0
0	<ul style="list-style-type: none"> <li>■ Bit 0, 1: Temperature system               <ul style="list-style-type: none"> <li>- 00: °C</li> <li>- 01: °F</li> <li>- 10: K</li> </ul> </li> <li>■ Bit 7 ... 2: reserved</li> </ul>

**CHxFN Function number**  
**channel x**

In the following there are the measuring ranges with corresponding function number listed, which were supported by the analog module. The formulas listed here allow you to transform an evaluated measuring value (analog value) to a value assigned to the measuring range (digital value) and vice versa.



With FFh the corresponding channel is deactivated.

**Voltage**

-80 ... 80mV

Meas. range (funct. no.)	Voltage (U)	Decimal (D)	Hex	Range	Formulas
-80 ... 80mV Siemens S7 format (11h)	94.07mV	32511	7EFFh	overrange	$D = 27648 \cdot \frac{U}{80}$ $U = D \cdot \frac{80}{27648}$
	80mV	27648	6C00h	nominal range	
	0V	0	0000h		
	-80mV	-27648	9400h		
	-94.07mV	-32512	8100h	underrange	

**Temperature**

Typ J	in °C	Values	in °F	Values	in K	Values	Range
[Fe-Cu-Ni IEC]	>1200	32767	>2192	32767	>1473.2	32767	overflow
	-210...1200	-2100...1200 0	-346...2192	-3460...2192 0	63.2...1473.2	632...14732	nominal range



Typ J	in °C	Values	in °F	Values	in K	Values	Range
	<-210	-32768	<-346	-32768	<63.2	-32768	underflow
Typ K	in °C	Values	in °F	Values	in K	Values	Range
[Ni-Cr-Ni]	>1372	32767	>2501.6	32767	>1645.2	32767	overflow
	-270...1372	-2700...1372 0	-454...2501.6	-4540...2501 6	0...1645.2	0...16452	nominal range
	<270	-32768	<-454	-32768	<0	-32768	underflow
Typ N	in °C	Values	in °F	Values	in K	Values	Range
[Ni-Cr-Si]	>1300	32767	>2372	32767	>1573,.2	32767	overflow
	-270...1300	-2700...1300 0	-454...2372	-4540...2372 0	0...1573.2	0...15732	nominal range
	<-270	-32768	<-454	-32768	<0	-32768	underflow
Typ R	in °C	Values	in °F	Values	in K	Values	Range
[PtRh-Pt]	>1769	32767	>3216.2	32767	>2042.2	32767	overflow
	-50...1769	-500...17690	-58...3216.2	-580...32162	223,.2...2042 .2	2232...20422	nominal range
	<-50	-32768	<-58	-32768	<223.2	-32768	underflow
Typ S	in °C	Values	in °F	Values	in K	Values	Range
[PtRh-Pt]	>1769	32767	>3216.2	32767	>2042.2	32767	overflow
	-50...1769	-500...17690	-58...3216.2	-580...32162	223.2...2042. 2	2232...20422	nominal range
	<-50	-32768	<-58	-32768	<223.2	-32768	underflow
Typ T	in °C	Values	in °F	Values	in K	Values	Range
[Cu-Cu-Ni]	>400	32767	>752	32767	>673.2	32767	overflow
	-270...400	-2700 ... 4000	-454...752	-4540... 7520	3.2...673.2	32...6732	nominal range
	<-270	-32768	<-454	-32768	<3.2	-32768	underflow
Typ B	in °C	Values	in °F	Values	in K	Values	Range
[PtRh-PtRh]	>1820	32767	>3275.6	32767	>2093.2	32767	overflow
	100...1820	1000...18200	212...3275.6	2120...32756 1	373.2...2093. 2	3732...20932	nominal range
	<100	-32768	<212	-32768	<373.2	-32768	underflow
Typ C	in °C	Values	in °F	Values	in K	Values	Range
[WRe5- WRe26]	>2315	32767	>3275.6	32767	>2588.2	32767	overflow
	0...2315	0...23150	32...3275.6	320...37856 <sup>1</sup>	273.2...2588. 2	2732...25882	nominal range
	<0	-32768	<32	-32768	<273.2	-32768	underflow

031-1CF90 - AI 8x16Bit TC &gt; Parameter data

Typ E	in °C	Values	in °F	Values	in K	Values	Range
[Ni-Cr - Cu-Ni]	>1000	32767	>1832	32767	>1273.2	32767	overflow
	-270...1000	-2700...1000 0	-454...1832	-4540...1832 0	0...1273.2	0...12732	nominal range
	<-270	-32768	<-454	-32768	<0	-32768	underflow

Typ L	in °C	Values	in °F	Values	in K	Values	Range
[Fe-Cu-Ni]	>900	32767	>1652	32767	>1173,2	32767	overflow
	-200...900	-2000...9000	-328...1652	-3280...1652 0	73.2...1173.2	732...1732	nominal range
	<-200	-32768	<-328	-32768	<73.2	-32768	underflow

1) The temperature range in degree Fahrenheit for type B and type C cannot represent the upper range value compared to Centigrade, because of the limited range to 16bit for presented values, therefore, the highest possible value is  $3275.6^{\circ}\text{F} = 1802.5^{\circ}\text{C}$ .

### CHxFO function option channel x

Byte	Bit 7 ... 0
0	<ul style="list-style-type: none"> <li>■ Bit 3 ... 0: Conversion time (in ms) with interference frequency suppression (in Hz) <ul style="list-style-type: none"> <li>- 0000: Conversion time 100.0ms, interference frequency suppression 10Hz<sup>1</sup></li> <li>- 0001: Conversion time 20.0ms, interference frequency suppression 50Hz<sup>1</sup></li> <li>- 0010: Conversion time 16.7ms, interference frequency suppression 60Hz<sup>1</sup></li> <li>- 0011: Conversion time 2.5ms, interference frequency suppression 400Hz</li> </ul> </li> <li>■ Bit 7 ... 4: Degree of smoothing <ul style="list-style-type: none"> <li>- 0000: no smoothing</li> <li>- 0001: weak (moving average with 4 samples)</li> <li>- 0010: medium (moving average with 16 samples)</li> <li>- 0011: strong (moving average with 32 samples)</li> </ul> </li> </ul>

1) The tolerances of the technical data "with interference frequency suppression" are valid.



*Please note that if the function number of a channel is changed, the measurement buffer is cleared and the associated smoothing is restarted!*

### CHxUL / CHxLL limit value

You can specify an upper or lower limit value for each channel x:

- With CHxUL you specify an upper limit value. This is deactivated by specifying 7FFFh.
- With CHxLL you specify a lower limit value. This is deactivated by specifying 8000h.
- You may only specify values from the nominal range, otherwise you will get a parameterization error.
- As soon as your measured value is outside a limit value and you have activated limit value monitoring, a hardware interrupt is triggered.

**CHxCJT**  
**cold junction temperature**

For each channel x you can specify a reference temperature for the cold junction temperature:

- The resolution of the value is 0.1 for each technical unit (°C, °F and K, TEMPCNF) and must be within the valid range of the selected sensor type (see table CHxFN).  
Example: For a temperature of 25.0°C, a value of 250 must be written.
- If the compensation method is set to external (CHxFN), this value is used for sensor compensation.
- The values can be changed during runtime. A temperature gradient of max. 0.1°C / min. is recommended for an accurate measurement.
- With the default value 0°C / 32°F / 273K, the module has the same temperature measurement behavior as the 2-channel module with the order no. 031-1BB90.

**3.25.3 Diagnostics and interrupt**

Event	Hardware interrupt	Diagnostics interrupt	parameterizable
Error in project engineering/ parametrization	-	X	-
Wire break	-	X	X
Measuring range overflow	-	X	-
Measuring range underflow	-	X	-
Limit overflow	X	-	X
Limit underflow	X	-	X
Diagnostic buffer overflow	-	X	-
Communication error	-	X	-
Hardware interrupt lost	-	X	-

**Hardware interrupt**

So you may react to asynchronous events, there is the possibility to activate a hardware interrupt.

- A hardware interrupt interrupts the linear program sequence and jumps depending on the master system to a corresponding Interrupt routine. Here you can react to the hardware interrupt accordingly.
- With CANopen the hardware interrupt data is transferred via an emergency telegram.
- Operating with CPU, PROFIBUS and PROFINET the hardware interrupt data were transferred via diagnostics telegram.

SX Subindex for access via EtherCAT with Index 5000h

More can be found in the according manual of your bus coupler.

Name	Bytes	Function	Default	SX
PRIT_OL	1	Upper limit overflow channel x	00h	02h
PRIT_UL	1	Lower limit underflow channel x	00h	03h
PRIT_US	2	µs-Ticker	00h	04h (high byte) 05h (low byte)

**PRIT\_OL Limit overflow**

Byte	Bit 7 ... 0
0	<ul style="list-style-type: none"> <li>■ Bit 0: Limit overflow channel 0</li> <li>■ ...</li> <li>■ Bit 7: Limit overflow channel 7</li> </ul>

**PRIT\_UL Limit underflow**

Byte	Bit 7 ... 0
0	<ul style="list-style-type: none"> <li>■ Bit 0: Limit underflow channel 0</li> <li>■ ...</li> <li>■ Bit 7: Limit underflow channel 7</li> </ul>

**PRIT\_US  $\mu$ s ticker**

Byte	Bit 7 ... 0
0 ... 1	16bit $\mu$ s value at the moment of the interrupt

 *$\mu$ s ticker*

In the module there is a 32 bit timer ( $\mu$ s ticker). With PowerON the timer starts counting with 0. After  $2^{32}-1\mu$ s the timer starts with 0 again. PRIT\_US represents the lower 2 byte of the  $\mu$ s ticker value ( $0 \dots 2^{16}-1$ ).

**Diagnostic data**

Via the parametrization you may activate a diagnostic interrupt for the module. With a diagnostics interrupt the module serves for diagnostics data for diagnostic interrupt<sub>incoming</sub>. As soon as the reason for releasing a diagnostic interrupt is no longer present, the diagnostic interrupt<sub>going</sub> automatically takes place. All events of a channel between diagnostic interrupt<sub>incoming</sub> and diagnostic interrupt<sub>going</sub> are not stored and get lost. Within this time window (1. diagnostic interrupt<sub>incoming</sub> until last diagnostic interrupt<sub>going</sub>) the MF-LED of the module is on.

DS Record set for access via CPU, PROFIBUS and PROFINET. The access happens by DS 01h. Additionally the first 4 bytes may be accessed by DS 00h.

IX Index for access via CANopen. The access happens by IX 2F01h. Additionally the first 4 bytes may be accessed by IX 2F00h.

SX Subindex for access via EtherCAT with Index 5005h.

More can be found in the according manual of your bus coupler.

Name	Bytes	Function	Default	DS	IX	SX
ERR_A	1	Diagnostic	00h	01h	2F01h	02h
MODTYP	1	Module information	15h			03h
ERR_C	1	reserved	00h			04h
ERR_D	1	Diagnostic	00h			05h
CHTYP	1	Channel type	71h			06h
NUMBIT	1	Number diagnostic bits per channel	08h			07h
NUMCH	1	Number of channels of a module	08h			08h
CHERR	1	Channel error	00h			09h
CH0ERR	1	Channel-specific error channel 0	00h			0Ah
CH1ERR	1	Channel-specific error channel 1	00h			0Bh
CH2ERR	1	Channel-specific error channel 2	00h			0Ch
CH3ERR	1	Channel-specific error channel 3	00h			0Dh
CH4ERR	1	Channel-specific error channel 4	00h			0Eh
CH5ERR	1	Channel-specific error channel 5	00h			0Fh
CH6ERR	1	Channel-specific error channel 6	00h			10h
CH7ERR	1	Channel-specific error channel 7	00h			11h
DIAG_US	4	µs ticker	00h			13h

**ERR\_A Diagnostic**

Byte	Bit 7 ... 0
0	<ul style="list-style-type: none"> <li>■ Bit 0: set at module failure</li> <li>■ Bit 1: set at internal error</li> <li>■ Bit 2: set at external error</li> <li>■ Bit 3: set at channel error</li> <li>■ Bit 4: set at external auxiliary supply missing</li> <li>■ Bit 6 ... 5: reserved</li> <li>■ Bit 7: set at error in parametrization</li> </ul>

**MODTYP  
Module information**

Byte	Bit 7 ... 0
0	<ul style="list-style-type: none"> <li>■ Bit 3 ... 0: module class <ul style="list-style-type: none"> <li>– 0101b analog module</li> </ul> </li> <li>■ Bit 4: set at channel information present</li> <li>■ Bit 7 ... 5: reserved</li> </ul>

**ERR\_D Diagnostic**

Byte	Bit 7 ... 0
0	<ul style="list-style-type: none"> <li>■ Bit 2 ... 0: reserved</li> <li>■ Bit 3: set at internal diagnostics buffer overflow</li> <li>■ Bit 4: set at internal communication error</li> <li>■ Bit 5: reserved</li> <li>■ Bit 6: set at hardware interrupt lost</li> <li>■ Bit 7: reserved</li> </ul>

**CHTYP Channel type**

Byte	Bit 7 ... 0
0	<ul style="list-style-type: none"> <li>■ Bit 6 ... 0: Channel type <ul style="list-style-type: none"> <li>- 70h: Digital input</li> <li>- 71h: Analog input</li> <li>- 72h: Digital output</li> <li>- 73h: Analog output</li> <li>- 74h: Analog input/-output</li> <li>- 76h: Counter</li> </ul> </li> <li>■ Bit 7: reserved</li> </ul>

**NUMBIT Diagnostic bits**

Byte	Bit 7 ... 0
0	Number of diagnostic bits per channel (here 08h)

**NUMCH Channels**

Byte	Bit 7 ... 0
0	Number of channels of a module (here 08h)

**CHERR Channel error**

Byte	Bit 7 ... 0
0	<ul style="list-style-type: none"> <li>■ Bit 0: set at error in channel 0</li> <li>■ Bit 1: set at error in channel 1</li> <li>■ Bit 2: set at error in channel 2</li> <li>■ Bit 3: set at error in channel 3</li> <li>■ Bit 4: set at error in channel 4</li> <li>■ Bit 5: set at error in channel 5</li> <li>■ Bit 6: set at error in channel 6</li> <li>■ Bit 7: set at error in channel 7</li> </ul>

**CH0ERR ... CH7ERR**  
Channel-specific

Byte	Bit 7 ... 0
0	Channel-specific error: Channel x: <ul style="list-style-type: none"> <li>■ Bit 0: set at project engineering/parametrization error</li> <li>■ Bit 2 ... 1: reserved</li> <li>■ Bit 3: set in the event of a defect in the internal temperature compensation. Please contact our support.<sup>1</sup></li> <li>■ Bit 4: set at wire break</li> <li>■ Bit 5: set at hardware interrupt lost</li> <li>■ Bit 6: set at measuring range underflow</li> <li>■ Bit 7: set at measuring range overflow</li> </ul>

1) This error is only reported if internal temperature compensation is set for the respective channel and this is defective.

**DIAG\_US  $\mu$ s ticker**

Byte	Bit 7 ... 0
0...3	Value of the $\mu$ s ticker at the moment of the diagnostic

 *$\mu$ s ticker*

In the System SLIO module there is a timer ( $\mu$ s ticker). With PowerON the timer starts counting with 0. After  $2^{32}-1\mu$ s the timer starts with 0 again.

### 3.26 031-1LB90 - AI 2x16Bit TC

#### Properties

The electronic module has 2 inputs for temperature and voltage measuring with parameterizable functions. The channels of the module are isolated to the backplane bus.

- 2 analog inputs
- Suited for sensors with type J, K, N, R, S, T, B, C, E, L and for voltage measuring  $\pm 80\text{mV}$
- Diagnostics function
- 16bit resolution
- Internal temperature compensation
- High potential gradient of DC75V/AC50V between the inputs

#### Structure

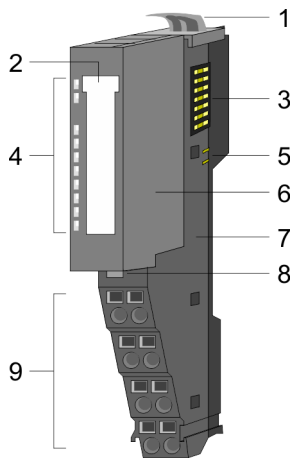

- 1 Locking lever terminal module
- 2 Labeling strip
- 3 Backplane bus
- 4 LED status indication
- 5 DC 24V power section supply
- 6 Electronic module
- 7 Terminal module
- 8 Locking lever electronic module
- 9 Terminal

#### Status indication

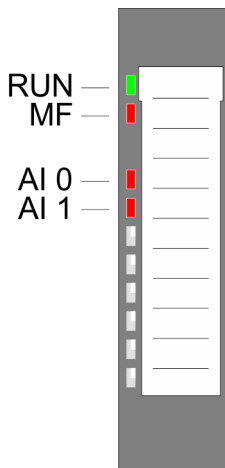

RUN	MF	AI x	Description
<input checked="" type="checkbox"/> green	<input checked="" type="checkbox"/> red	<input checked="" type="checkbox"/> red	
<input checked="" type="checkbox"/>	<input type="checkbox"/>	X	Bus communication is OK Module status is OK
<input checked="" type="checkbox"/>	<input checked="" type="checkbox"/>	X	Bus communication is OK Module status reports an error
<input type="checkbox"/>	<input checked="" type="checkbox"/>	X	Bus communication is not possible Module status reports an error
<input type="checkbox"/>	<input type="checkbox"/>	X	Error at bus power supply
X	<input checked="" type="checkbox"/>	X	Error in configuration → <a href="#">‘Trouble shooting - LEDs’...page 41</a>
<input checked="" type="checkbox"/>	<input type="checkbox"/>	<input checked="" type="checkbox"/>	Error channel x <ul style="list-style-type: none"> <li>■ Signal leaves measuring range</li> <li>■ Error in parameterization</li> <li>■ Wire break (if parameterized)</li> </ul>
not relevant: X			



Pin assignment

For wires with a cross section of 0.08mm<sup>2</sup> up to 1.5mm<sup>2</sup>.

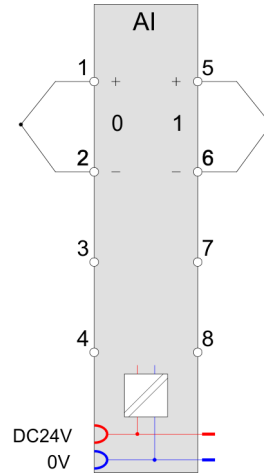
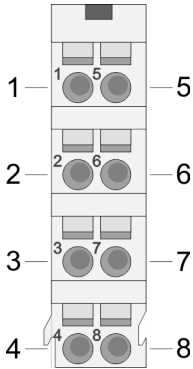

Pos.	Function	Type	Description
1	+TC 0	I	+ Channel 0
2	-TC 0	I	Ground Channel 0
3	---	---	not connected
4	---	---	not connected
5	+TC 1	I	+ Channel 1
6	-TC 1	I	Ground Channel 1
7	---	---	not connected
8	---	---	not connected

I: Input



**CAUTION**

Please consider that the electronic module AI 2x16Bit TC may exclusively be used together with the terminal module 001-0AA20!



*Please take care of the correct polarity when installing the sensors!  
Please install short circuits at non-used inputs by connecting the positive contact with the channel ground of the according channel.*

**Supplementation to the installation guidelines**

To avoid variations in temperature within the module, which may affect the accuracy of the measurement, you should consider the following points when assembling:

- Do not arrange the module directly apart from a power module with a high feeding current.
- Do not install the module at the end of a line.
- The module should be in a static condition, i.e. the temperature should be as constant as possible in the environment of your module (closed switchgear cabinet free from air draught).
- The accuracy is reached after approx. 30 minutes after entering the static condition.

**In-/Output area**

At CPU, PROFIBUS and PROFINET the input respectively output area is embedded to the corresponding address area.

**IX** Index for access via CANopen with s = Subindex, depends on number and type of analog modules

**SX** Subindex for access via EtherCAT with Index 6000h + EtherCAT-Slot

More can be found in the according manual of your bus coupler.

**Input area**

Addr.	Name	Bytes	Function	IX	SX
+0	AI 0	2	Analog value channel 0	6401h/s	01h
+2	AI 1	2	Analog value channel 1	6401h/s+1	02h

**Output area**

No byte of the output area is used by the module.

**3.26.1 Technical data**

<b>Order no.</b>	<b>031-1LB90</b>
Type	SM 031 - Analog input
Module ID	040F 1543
<b>Current consumption/power loss</b>	
Current consumption from backplane bus	55 mA
Power loss	1 W
<b>Technical data analog inputs</b>	
Number of inputs	2
Cable length, shielded	200 m
Rated load voltage	DC 24 V
Current consumption from load voltage L+ (without load)	30 mA
Voltage inputs	-
Min. input resistance (voltage range)	10 MΩ
Input voltage ranges	-80 mV ... +80 mV
Operational limit of voltage ranges	±0.3%
Operational limit of voltage ranges with SFU	±0.1%
Basic error limit voltage ranges	±0.25%
Basic error limit voltage ranges with SFU	±0.05%
Destruction limit voltage	max. 20V
Current inputs	-
Max. input resistance (current range)	-
Input current ranges	-
Operational limit of current ranges	-
Operational limit of current ranges with SFU	-
Basic error limit current ranges	-
Radical error limit current ranges with SFU	-

Order no.	031-1LB90
Destruction limit current inputs (voltage)	-
Destruction limit current inputs (electrical current)	-
Resistance inputs	-
Resistance ranges	-
Operational limit of resistor ranges	-
Operational limit of resistor ranges with SFU	-
Basic error limit	-
Basic error limit with SFU	-
Destruction limit resistance inputs	-
Resistance thermometer inputs	-
Resistance thermometer ranges	-
Operational limit of resistance thermometer ranges	-
Operational limit of resistance thermometer ranges with SFU	-
Basic error limit thermoresistor ranges	-
Basic error limit thermoresistor ranges with SFU	-
Destruction limit resistance thermometer inputs	-
Thermocouple inputs	✓
Thermocouple ranges	type B type C type E type J type K type L type N type R type S type T
Operational limit of thermocouple ranges	Type E, L, T, J, K, N: $\pm 2.5K$ / Type B, C, R, S: $\pm 8.0K$
Operational limit of thermocouple ranges with SFU	Type E, L, T, J, K, N: $\pm 1.5K$ / Type B, C, R, S: $\pm 4.0K$
Basic error limit thermocouple ranges	Type E, L, T, J, K, N: $\pm 2.0K$ / Type B, C, R, S: $\pm 7.0K$
Basic error limit thermocouple ranges with SFU	Type E, L, T, J, K, N: $\pm 1.0K$ / Type B, C, R, S: $\pm 3.0K$
Destruction limit thermocouple inputs	max. 20V
Programmable temperature compensation	✓
External temperature compensation	✓
Internal temperature compensation	✓
Temperature error internal compensation	1 K
Technical unit of temperature measurement	°C, °F, K
Resolution in bit	16

Order no.	031-1LB90
Measurement principle	Sigma-Delta
Basic conversion time	84.2 ms (50 Hz) 70.5 ms (60 Hz) per channel
Noise suppression for frequency	>90dB at 50Hz (UCM<10V)
<b>Status information, alarms, diagnostics</b>	
Status display	yes
Interrupts	yes
Process alarm	no
Diagnostic interrupt	yes, parameterizable
Diagnostic functions	yes
Diagnostics information read-out	possible
Module state	green LED
Module error display	red LED
Channel error display	red LED per channel
<b>Isolation</b>	
Between channels	-
Between channels of groups to	-
Between channels and backplane bus	✓
Between channels and power supply	-
Max. potential difference between circuits	-
Max. potential difference between inputs (Ucm)	DC 75 V/ AC 50 V
Max. potential difference between Mana and Mintern (Uiso)	-
Max. potential difference between inputs and Mana (Ucm)	-
Max. potential difference between inputs and Mintern (Uiso)	DC 75 V/ AC 50 V
Max. potential difference between Mintern and outputs	-
Insulation tested with	DC 500 V
<b>Technical data encoder supply</b>	
Number of outputs	-
Output voltage (typ)	-
Output voltage (rated value)	-
Short-circuit protection	-
Binding of potential	-
<b>Datasizes</b>	
Input bytes	4
Output bytes	0
Parameter bytes	10
Diagnostic bytes	20

<b>Order no.</b>	<b>031-1LB90</b>
<b>Housing</b>	
Material	PPE / PPE GF10
Mounting	Profile rail 35 mm
<b>Mechanical data</b>	
Dimensions (WxHxD)	12.9 mm x 109 mm x 76.5 mm
Net weight	58 g
Weight including accessories	58 g
Gross weight	72 g
<b>Environmental conditions</b>	
Operating temperature	0 °C to 60 °C
Storage temperature	-25 °C to 70 °C
<b>Certifications</b>	
UL certification	yes
KC certification	yes
UKCA certification	yes
ChinaRoHS certification	yes

SFU Interference frequency suppression

The indicated error limits are valid starting from the following temperatures:

- Thermoelement type T: -200 °C
- Thermoelement type K: -100 °C
- Thermoelement type B: +700 °C
- Thermoelement type N: -150 °C
- Thermoelement type E: -150 °C
- Thermoelement type R: +200 °C
- Thermoelement type S: +100 °C
- Thermoelement type J: -100 °C

## 3.26.2 Parameter data

- DS Record set for access via CPU, PROFIBUS and PROFINET  
 IX Index for access via CANopen  
 SX Subindex for access via EtherCAT with Index 3100h + EtherCAT-Slot  
 More can be found in the according manual of your bus coupler.

Name	Bytes	Function	Default	DS	IX	SX
DIAG_EN	1	Diagnostics <sup>1</sup>	00h	00h	3100h	01h
WIBRK_EN	1	Wire break recognition <sup>1</sup>	00h	00h	3101h	02h
TEMPCNF	1	Temperature system	00h	01h	3102h	03h
SUPR	1	Interference frequency suppression (SFU)	02h	01h	3103h	04h
CH0FN	1	Function number channel 0	C1h	80h	3104h	05h
CH1FN	1	Function number channel 1	C1h	81h	3105h	06h

1) This record set may only be transferred at STOP state.

#### DIAG\_EN Diagnostic interrupt

Byte	Bit 7 ... 0
0	<ul style="list-style-type: none"> <li>■ Diagnostic interrupt               <ul style="list-style-type: none"> <li>- 00h: disabled</li> <li>- 40h: enabled</li> </ul> </li> </ul>

- Here you can enable respectively disable the diagnostic interrupt.

#### WIBRK\_EN Wire break recognition

Byte	Bit 7 ... 0
0	<ul style="list-style-type: none"> <li>■ Bit 0: Wire break recognition channel 0 (1: on)</li> <li>■ Bit 1: Wire break recognition channel 1 (1: on)</li> <li>■ Bit 7 ... 2: reserved</li> </ul>



*Due to the high sensitivity of the inputs, unused inputs should be deactivated in the parametrization. Due to the high input impedance, open inputs can be influenced by adjacent channels or due to the measuring method during wire break detection. Since the entire measuring range moves in the mV range, open-loop inputs can already cause measuring range overshoots.*

#### TEMPCNF Temperature system

Byte	Bit 7 ... 0
0	<ul style="list-style-type: none"> <li>■ Bit 0, 1: Temperature system               <ul style="list-style-type: none"> <li>- 00: °C</li> <li>- 01: °F</li> <li>- 10: K</li> </ul> </li> <li>■ Bit 7 ... 2: reserved</li> </ul>

**SUPR Interference frequency suppression (SFU)**

Byte	Bit 7 ... 0
0	<ul style="list-style-type: none"> <li>■ Bit 0, 1: Interference frequency suppression               <ul style="list-style-type: none"> <li>- 01: 60Hz</li> <li>- 10: 50Hz</li> </ul> </li> <li>■ Bit 7 ... 2: reserved</li> </ul>

**CHxFN Function number channel x**

In the following there are the measuring ranges with corresponding function number listed, which were supported by the analog module. With FFh the corresponding channel is deactivated.

Meas. range Voltage -80 ... 80mV (funct. no.)	Voltage (U)	Decimal (D)	Hex	Range	Formulas
-80 ... 80mV Siemens S7 format (11h)	94.07mV	32511	7EFFh	overrange	$D = 27648 \cdot \frac{U}{80}$ $U = D \cdot \frac{80}{27648}$
	80mV	27648	6C00h	nominal range	
	0V	0	0000h		
	-80mV	-27648	9400h		
	-94.07mV	-32512	8100h	underrange	
-80 ... 80mV Siemens S5 format (21h)	100mV	20480	5000h	overrange	$D = 16384 \cdot \frac{U}{80}$ $U = D \cdot \frac{80}{16384}$
	80mV	16384	4000h	nominal range	
	0V	0	0000h		
	-80mV	-16384	C000h		
	-100mV	-20480	B000h	underrange	

Measuring range Temperature (funct. no.)	Measuring value in °C (0.1°C/digit)	Measuring value in °F (0.1°F/digit)	Measuring value in K (0.1K/digit)	Range
Type J: [Fe-Cu-Ni IEC] -210 ... +1200°C -346 ... 2192°F 63.2 ... 1473.2K (B0h: ext. comp. 0°C) (C0h: int. comp. 0°C)	+14500	26420	17232	overrange
	-2100 ... +12000	-3460 ... 21920	632 ... 14732	nominal range
	---	---	---	underrange
Type K: [Ni-Cr-Ni] -270 ... +1372°C -454 ... 2501.6°F 0 ... 1645.2K (B1h: ext. comp. 0°C) (C1h: int. comp. 0°C)	+16220	29516	18952	overrange
	-2700 ... +13720	-4540 ... 25016	0 ... 16452	nominal range
	---	---	---	underrange

031-1LB90 - AI 2x16Bit TC &gt; Parameter data

Measuring range Temperature (funct. no.)	Measuring value in °C (0.1°C/digit)	Measuring value in °F (0.1°F/digit)	Measuring value in K (0.1K/digit)	Range
Type N:	+15500	28220	18232	overrange
[Ni-Cr-Si]	-2700 ... +13000	-4540 ... 23720	0 ... 15732	nominal range
-270 ... +1300°C	---	---	---	underrange
-454 ... 2372°F				
0 ... 1573.2K				
(B2h: ext. comp. 0°C)				
(C2h: int. comp. 0°C)				
Type R:	+20190	32766	22922	overrange
[PtRh-Pt]	-500 ... +17690	-580 ... 32162	2232 ... 20422	nominal range
-50 ... +1769°C	-1700	-2740	1032	underrange
-58 ... 3216.2°F				
223.2 ... 2042.2K				
(B3h: ext. comp. 0°C)				
(C3h: int. comp. 0°C)				
Type S:	+20190	32766	22922	overrange
[PtRh-Pt]	-500 ... +17690	-580 ... 32162	2232 ... 20422	nominal range
-50 ... +1769°C	-1700	-2740	1032	underrange
-58 ... 3216.2°F				
223.2 ... 2042.2K				
(B4h: ext. comp. 0°C)				
(C4h: int. comp. 0°C)				
Type T:	+5400	10040	8132	overrange
[Cu-Cu-Ni]	-2700 ... +4000	-4540 ... 7520	32 ... 6732	nominal range
-270 ... +400°C	---	---	---	underrange
-454 ... 752°F				
3.2 ... 673.2K				
(B5h: ext. comp. 0°C)				
(C5h: int. comp. 0°C)				
Type B:	+20700	32766	23432	overrange
[PtRh-PtRh]	0 ... +18200	320 ... 27865	2732 ... 20932	nominal range
0 ... +1820°C	-1200	-1840	1532	underrange
32 ... 2786.5°F				
273.2 ... 2093.2K				
(B6h: ext. comp. 0°C)				
(C6h: int. comp. 0°C)				
Type C:	+25000	32766	23432	overrange
[WRe5-WRe26]	0 ... +23150	320 ... 27865	2732 ... 20932	nominal range
0 ... +2315°C	-1200	-1840	1532	underrange



Measuring range Temperature (funct. no.)	Measuring value in °C (0.1°C/digit)	Measuring value in °F (0.1°F/digit)	Measuring value in K (0.1K/digit)	Range
32 ... 2786.5°F 273.2 ... 2093.2K (B7h: ext. comp. 0°C) (C7h: int. comp. 0°C)				
Type E:	+12000	21920	14732	overrange
[Ni-Cr - Cu-Ni ]	-2700 ... +10000	-4540 ... 18320	0 ... 12732	nominal range
-270 ... +1000°C -454 ... 1832°F 0 ... 1273.2K (B8h: ext. comp. 0°C) (C8h: int. comp. 0°C)	---	---	---	underrange
Type L:	+11500	21020	14232	overrange
[Fe-Cu-Ni]	-2000 ... +9000	-3280 ... 16520	732 ... 11732	nominal range
-200 ... +900°C -328 ... 1652°F 73.2 ... 1173.2K (B9h: ext. comp. 0°C) (C9h: int. comp. 0°C)	---	---	---	underrange

### 3.26.3 Diagnostic data

So this module does not support diagnostic interrupt functions, the diagnostics data serve for information about this module. On error the corresponding channel LED of the module is activated and the error is registered in the diagnostics data.

The following errors are listed in the diagnostics data:

- Error in project engineering / parameterization
- Measuring range overflow
- Measuring range underflow

DS Record set for access via CPU, PROFIBUS and PROFINET. The access happens by DS 01h. Additionally the first 4 bytes may be accessed by DS 00h.

IX Index for access via CANopen. The access happens by IX 2F01h. Additionally the first 4 bytes may be accessed by IX 2F00h.

SX Subindex for access via EtherCAT with Index 5005h.

More can be found in the according manual of your bus coupler.

031-1LB90 - AI 2x16Bit TC &gt; Diagnostic data

Name	Bytes	Function	Default	DS	IX	SX
ERR_A	1	Diagnostic	00h	01h	2F01h	02h
MODTYP	1	Module information	15h			03h
RES2	1	reserved	00h			04h
ERR_D	1	Diagnostic	00h			05h
CHTYP	1	Channel type	71h			06h
NUMBIT	1	Number diagnostic bits per channel	08h			07h
NUMCH	1	Number of channels of a module	02h			08h
CHERR	1	Channel error	00h			09h
CH0ERR	1	Channel-specific error channel 0	00h			0Ah
CH1ERR	1	Channel-specific error channel 1	00h			0Bh
CH2ERR... CH7ERR	6	reserved	00h			0Ch ... 11h
DIAG_US	4	µs ticker	00h			13h

**ERR\_A Diagnostic**

Byte	Bit 7 ... 0
0	<ul style="list-style-type: none"> <li>■ Bit 0: set at module failure</li> <li>■ Bit 1: set at internal error</li> <li>■ Bit 2: set at external error</li> <li>■ Bit 3: set at channel error</li> <li>■ Bit 4: set at external auxiliary supply missing</li> <li>■ Bit 6 ... 5: reserved</li> <li>■ Bit 7: set at error in parametrization</li> </ul>

**MODTYP**  
*Module information*

Byte	Bit 7 ... 0
0	<ul style="list-style-type: none"> <li>■ Bit 3 ... 0: module class <ul style="list-style-type: none"> <li>– 0101b analog module</li> </ul> </li> <li>■ Bit 4: set at channel information present</li> <li>■ Bit 7 ... 5: reserved</li> </ul>

**ERR\_D Diagnostic**

Byte	Bit 7 ... 0
0	<ul style="list-style-type: none"> <li>■ Bit 2 ... 0: reserved</li> <li>■ Bit 3: set at internal diagnostics buffer overflow</li> <li>■ Bit 4: set at internal communication error</li> <li>■ Bit 7 ... 5: reserved</li> </ul>

**CHTYP Channel type**

Byte	Bit 7 ... 0
0	<ul style="list-style-type: none"> <li>■ Bit 6 ... 0: Channel type               <ul style="list-style-type: none"> <li>- 70h: Digital input</li> <li>- 71h: Analog input</li> <li>- 72h: Digital output</li> <li>- 73h: Analog output</li> <li>- 74h: Analog input/-output</li> <li>- 76h: Counter</li> </ul> </li> <li>■ Bit 7: reserved</li> </ul>

**NUMBIT Diagnostic bits**

Byte	Bit 7 ... 0
0	Number of diagnostic bits per channel (here 08h)

**NUMCH Channels**

Byte	Bit 7 ... 0
0	Number of channels of a module (here 02h)

**CHERR Channel error**

Byte	Bit 7 ... 0
0	<ul style="list-style-type: none"> <li>■ Bit 0: set at error in channel group 0</li> <li>■ Bit 1: set at error in channel group 1</li> <li>■ Bit 7 ... 2: reserved</li> </ul>

**CH0ERR / CH1ERR  
Channel-specific**

Byte	Bit 7 ... 0
0	Channel-specific error: Channel x: <ul style="list-style-type: none"> <li>■ Bit 0: set at project engineering/parameterization error</li> <li>■ Bit 3 ... 1: reserved</li> <li>■ Bit 4: set at wire break</li> <li>■ Bit 5: reserved</li> <li>■ Bit 6: set at measuring range underflow</li> <li>■ Bit 7: set at measuring range overflow</li> </ul>

**CH2ERR ... CH7ERR  
reserved**

Byte	Bit 7 ... 0
0	reserved

**DIAG\_US  $\mu$ s ticker**

Byte	Bit 7 ... 0
0...3	Value of the $\mu$ s ticker at the moment of the diagnostic

 *$\mu$ s ticker*

In the System SLIO module there is a timer ( $\mu$ s ticker). With PowerON the timer starts counting with 0. After  $2^{32}-1\mu$ s the timer starts with 0 again.

### 3.27 031-1LD80 - AI 4x16Bit R/RTD

#### Properties

The electronic module has 4 inputs for resistance measurement with parameterizable functions. The channels of the module are isolated to the backplane bus.

- 4 analog inputs
- Suited for resistance-type sensors 0 ... 3000Ω and resistance temperature sensors Pt100, Pt1000, NI100, NI120 and NI1000
- Resistance measurement with 2, 3 and 4 wire (3 and 4 wire only via channel 0 respectively 1)
- Diagnostics function
- 16bit resolution

#### Structure

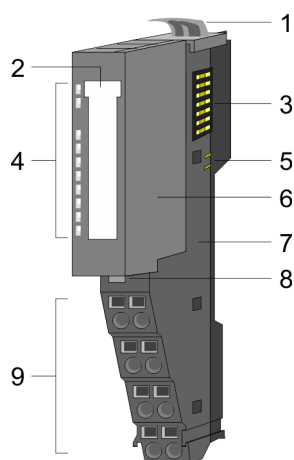

- 1 Locking lever terminal module
- 2 Labeling strip
- 3 Backplane bus
- 4 LED status indication
- 5 DC 24V power section supply
- 6 Electronic module
- 7 Terminal module
- 8 Locking lever electronic module
- 9 Terminal

#### Status indication

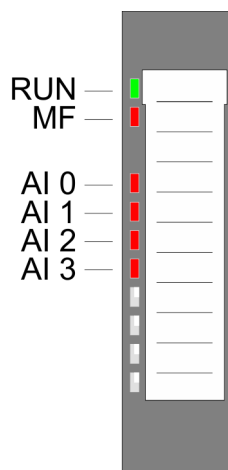

RUN	MF	AI x	Description
<input checked="" type="checkbox"/> green	<input checked="" type="checkbox"/> red	<input checked="" type="checkbox"/> red	
<input checked="" type="checkbox"/>	<input type="checkbox"/>	X	Bus communication is OK Module status is OK
<input checked="" type="checkbox"/>	<input checked="" type="checkbox"/>	X	Bus communication is OK Module status reports an error
<input type="checkbox"/>	<input checked="" type="checkbox"/>	X	Bus communication is not possible Module status reports an error
<input type="checkbox"/>	<input type="checkbox"/>	X	Error at bus power supply
X	<input checked="" type="checkbox"/>	X	Error in configuration → <a href="#">'Trouble shooting - LEDs'...page 41</a>
<input checked="" type="checkbox"/>	<input type="checkbox"/>	<input checked="" type="checkbox"/>	Error channel x <ul style="list-style-type: none"> <li>■ Signal leaves measuring range</li> <li>■ Error in parameterization</li> <li>■ Wire break (if parameterized)</li> </ul>
not relevant: X			

## Pin assignment

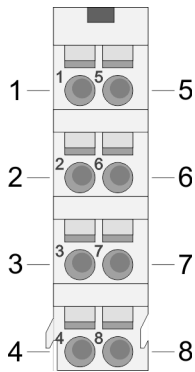

For wires with a cross section of 0.08mm<sup>2</sup> up to 1.5mm<sup>2</sup>.

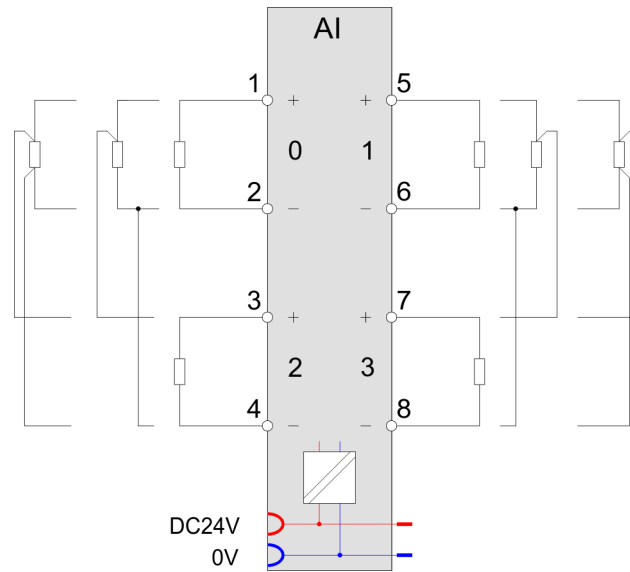

Pos.	Function	Type	Description
1	+AI 0	I	+ Channel 0
2	-AI 0	I	Ground Channel 0
3	+AI 2	I	+ Channel 2
4	-AI 2	I	Ground Channel 2
5	+AI 1	I	+ Channel 1
6	-AI 1	I	Ground Channel 1
7	+AI 3	I	+ Channel 3
8	-AI 3	I	Ground Channel 3

I: Input

## 2, 3, 4 wire measurement

At the pin assignment above you can see how the sensors are to be connected at 2, 3 respectively 4 wire measurement.

- With every channel a 2 wire measurement may be performed.
- 3 wire measurement is only possible via the channels 0 and 1.
  - Please consider with 3 wire measurement that the corresponding channel is always deactivated in the parametrization. The corresponding channel of channel 0 is channel 2 and of channel 1 is channel 3. Not used channels must always be de-activated in the parametrization.
- 4 wire measurement is only possible via the channels 0 and 1.
  - The measurement current for channel 0 is applied at pin 1 and 2. The measurement for channel 0 happens at pin 3 and 4. The analog value for channel 0 is represented in input word 0.
  - The measurement current for channel 1 is applied at pin 5 and 6. The measurement for channel 1 happens at pin 7 and 8. The analog value for channel 1 is represented in input word 1.
  - Please consider with 4 wire measurement that the corresponding channel is always deactivated in the parametrization. The corresponding channel of channel 0 is channel 2 and of channel 1 is channel 3. Not used channels must always be de-activated in the parametrization.

**In-/Output area**

At CPU, PROFIBUS and PROFINET the input respectively output area is embedded to the corresponding address area.

IX Index for access via CANopen with s = Subindex, depends on number and type of analog modules

SX Subindex for access via EtherCAT with Index 6000h + EtherCAT-Slot

More can be found in the according manual of your bus coupler.

**Input area**

Addr.	Name	Bytes	Function	IX	SX
+0	AI 0	2	Analog value channel 0	6401h/s	01h
+2	AI 1	2	Analog value channel 1	6401h/s+1	02h
+4	AI 2	2	Analog value channel 2	6401h/s+2	03h
+6	AI 3	2	Analog value channel 3	6401h/s+3	04h

**Output area**

No byte of the output area is used by the module.

**3.27.1 Technical data**

<b>Order no.</b>	<b>031-1LD80</b>
Type	SM 031 - Analog input
Module ID	0410 1544
<b>Current consumption/power loss</b>	
Current consumption from backplane bus	55 mA
Power loss	1 W
<b>Technical data analog inputs</b>	
Number of inputs	4
Cable length, shielded	200 m
Rated load voltage	DC 24 V
Current consumption from load voltage L+ (without load)	30 mA
Voltage inputs	-
Min. input resistance (voltage range)	-
Input voltage ranges	-
Operational limit of voltage ranges	-
Operational limit of voltage ranges with SFU	-
Basic error limit voltage ranges	-
Basic error limit voltage ranges with SFU	-
Destruction limit voltage	-
Current inputs	-
Max. input resistance (current range)	-
Input current ranges	-
Operational limit of current ranges	-
Operational limit of current ranges with SFU	-

Order no.	031-1LD80
Basic error limit current ranges	-
Radical error limit current ranges with SFU	-
Destruction limit current inputs (voltage)	-
Destruction limit current inputs (electrical current)	-
Resistance inputs	✓
Resistance ranges	0 ... 60 Ohm 0 ... 600 Ohm 0 ... 3000 Ohm
Operational limit of resistor ranges	+/- 0.4 %
Operational limit of resistor ranges with SFU	+/- 0.2 %
Basic error limit	+/- 0.2 %
Basic error limit with SFU	+/- 0.1 %
Destruction limit resistance inputs	max. 24V
Resistance thermometer inputs	✓
Resistance thermometer ranges	Pt100 Pt1000 Ni100 Ni120 Ni1000
Operational limit of resistance thermometer ranges	+/- 0.4 %
Operational limit of resistance thermometer ranges with SFU	+/- 0.2 %
Basic error limit thermoresistor ranges	+/- 0.2 %
Basic error limit thermoresistor ranges with SFU	+/- 0.1 %
Destruction limit resistance thermometer inputs	max. 24V
Thermocouple inputs	-
Thermocouple ranges	-
Operational limit of thermocouple ranges	-
Operational limit of thermocouple ranges with SFU	-
Basic error limit thermocouple ranges	-
Basic error limit thermocouple ranges with SFU	-
Destruction limit thermocouple inputs	-
Programmable temperature compensation	-
External temperature compensation	-
Internal temperature compensation	-
Temperature error internal compensation	-
Technical unit of temperature measurement	°C, °F, K
Resolution in bit	16

Order no.	031-1LD80
Measurement principle	Sigma-Delta
Basic conversion time	84.2 ms (50 Hz) 70.5 ms (60 Hz) per channel
Noise suppression for frequency	>80dB at 50Hz (UCM<6V)
<b>Status information, alarms, diagnostics</b>	
Status display	yes
Interrupts	yes, parameterizable
Process alarm	no
Diagnostic interrupt	yes, parameterizable
Diagnostic functions	yes
Diagnostics information read-out	possible
Module state	green LED
Module error display	red LED
Channel error display	red LED per channel
<b>Isolation</b>	
Between channels	-
Between channels of groups to	-
Between channels and backplane bus	✓
Between channels and power supply	-
Max. potential difference between circuits	-
Max. potential difference between inputs (U <sub>cm</sub> )	DC 6 V
Max. potential difference between Mana and Mintern (U <sub>iso</sub> )	-
Max. potential difference between inputs and Mana (U <sub>cm</sub> )	-
Max. potential difference between inputs and Mintern (U <sub>iso</sub> )	DC 75 V/ AC 50 V
Max. potential difference between Mintern and outputs	-
Insulation tested with	DC 500 V
<b>Technical data encoder supply</b>	
Number of outputs	-
Output voltage (typ)	-
Output voltage (rated value)	-
Short-circuit protection	-
Binding of potential	-
<b>Datasizes</b>	
Input bytes	8
Output bytes	0
Parameter bytes	12
Diagnostic bytes	20



<b>Order no.</b>	<b>031-1LD80</b>
<b>Housing</b>	
Material	PPE / PPE GF10
Mounting	Profile rail 35 mm
<b>Mechanical data</b>	
Dimensions (WxHxD)	12.9 mm x 109 mm x 76.5 mm
Net weight	61 g
Weight including accessories	61 g
Gross weight	75 g
<b>Environmental conditions</b>	
Operating temperature	0 °C to 60 °C
Storage temperature	-25 °C to 70 °C
<b>Certifications</b>	
UL certification	yes
KC certification	yes
UKCA certification	yes
ChinaRoHS certification	yes

SFU Interference frequency suppression

### 3.27.2 Parameter data

DS Record set for access via CPU, PROFIBUS and PROFINET

IX Index for access via CANopen

SX Subindex for access via EtherCAT with Index 3100h + EtherCAT-Slot

More can be found in the according manual of your bus coupler.

Name	Bytes	Function	Default	DS	IX	SX
DIAG_EN	1	Diagnostic <sup>1</sup>	00h	00h	3100h	01h
WIBRK_EN	1	Wire break recognition <sup>1</sup>	00h	00h	3101h	02h
TEMPCNF	1	Temperature system	00h	01h	3102h	03h
SUPR	1	Interference frequency suppression (SFU)	02h	01h	3103h	04h
CH0FN	1	Function number channel 0	50h	80h	3104h	05h
CH1FN	1	Function number channel 1	50h	81h	3105h	06h
CH2FN	1	Function number channel 2	50h <sup>2</sup>	82h	3106h	07h
CH3FN	1	Function number channel 3	50h <sup>2</sup>	83h	3107h	08h

1) This record set may only be transferred at STOP state.

2) with 2 channel operation FFh

031-1LD80 - AI 4x16Bit R/RTD &gt; Parameter data

**DIAG\_EN**  
Diagnostic interrupt

Byte	Bit 7 ... 0
0	<ul style="list-style-type: none"> <li>■ Diagnostic interrupt               <ul style="list-style-type: none"> <li>- 00h: disabled</li> <li>- 40h: enabled</li> </ul> </li> </ul>

- Here you can enable respectively disable the diagnostic interrupt.

**WIBRK\_EN**  
Wire break recognition

Byte	Bit 7 ... 0
0	<ul style="list-style-type: none"> <li>■ Bit 0: Wire break recognition channel 0 (1: on)</li> <li>■ Bit 1: Wire break recognition channel 1 (1: on)</li> <li>■ Bit 2: Wire break recognition channel 2 (1: on)</li> <li>■ Bit 3: Wire break recognition channel 3 (1: on)</li> <li>■ Bit 7 ... 4: reserved</li> </ul>

**TEMPCNF**  
Temperature system

Byte	Bit 7 ... 0
0	<ul style="list-style-type: none"> <li>■ Bit 1, 0: Temperature system               <ul style="list-style-type: none"> <li>- 00: °C</li> <li>- 01: °F</li> <li>- 10: K</li> </ul> </li> <li>■ Bit 7 ... 2: reserved</li> </ul>

**SUPR** Interference frequency suppression (SFU)

Byte	Bit 7 ... 0
0	<ul style="list-style-type: none"> <li>■ Bit 1, 0: Interference frequency suppression               <ul style="list-style-type: none"> <li>- 01: 60Hz</li> <li>- 10: 50Hz</li> </ul> </li> <li>■ Bit 7 ... 2: reserved</li> </ul>

**CHxFN** Function number channel x

In the following there are the measuring ranges with corresponding function number listed, which were supported by the analog module. With FFh the corresponding channel is deactivated.

Measuring range Resistance (funct. no.)	Measuring value	Signal range	Range
2 wire: PT100 (50h)	+1000°C	+10000	overrange
	-200 ... +850°C	-2000 ... +8500	nominal range
	-243°C	-2430	underrange
2 wire: PT1000 (51h)	+1000°C	+10000	overrange
	-200 ... +850°C	-2000 ... +8500	nominal range
	-243°C	-2430	underrange
2 wire: NI100 (52h)	+295°C	+2950	overrange
	-60 ... +250°C	-600 ... +2500	nominal range

Measuring range Resistance (funct. no.)	Measuring value	Signal range	Range
	-105°C	-1050	underrange
2 wire: NI1000 (53h)	+295°C	+2950	overrange
	-60 ... +250°C	-600 ... +2500	nominal range
	-105°C	-1050	underrange
2 wire: NI120 <sup>1</sup> (54h)	+400°C	+4000	overrange
	-80 ... +320°C	-800 ... +3200	nominal range
	-100°C	-1000	underrange
3 wire: PT100 (58h)	+1000°C	+10000	overrange
	-200 ... +850°C	-2000 ... +8500	nominal range
	-243°C	-2430	underrange
3 wire: PT1000 (59h)	+1000°C	+10000	overrange
	-200 ... +850°C	-2000 ... +8500	nominal range
	-243°C	-2430	underrange
3 wire: NI100 (5Ah)	+295°C	+2950	overrange
	-60 ... +250°C	-600 ... +2500	nominal range
	-105°C	-1050	underrange
3 wire: NI1000 (5Bh)	+295°C	+2950	overrange
	-60 ... +250°C	-600 ... +2500	nominal range
	-105°C	-1050	underrange
3 wire: NI120 <sup>1</sup> (5Ch)	+400°C	+4000	overrange
	-80 ... +320°C	-800 ... +3200	nominal range
	-100°C	-1000	underrange
4 wire: PT100 (60h)	+1000°C	+10000	overrange
	-200 ... +850°C	-2000 ... +8500	nominal range
	-243°C	-2430	underrange
4 wire: PT1000 (61h)	+1000°C	+10000	overrange
	-200 ... +850°C	-2000 ... +8500	nominal range
	-243°C	-2430	underrange
4 wire: NI100 (62h)	+295°C	+2950	overrange
	-60 ... +250°C	-600 ... +2500	nominal range
	-105°C	-1050	underrange
4 wire: NI1000 (63h)	+295°C	+2950	overrange
	-60 ... +250°C	-600 ... +2500	nominal range
	-105°C	-1050	underrange
4 wire: NI120 <sup>1</sup> (64h)	+400°C	+4000	overrange
	-80 ... +320°C	-800 ... +3200	nominal range
	-100°C	-1000	underrange

031-1LD80 - AI 4x16Bit R/RTD &gt; Parameter data

Measuring range Resistance (funct. no.)	Measuring value	Signal range	Range
2 wire: 0 ... 60Ω (70h)	---	---	overrange
	0 ... 60Ω	0 ... 32767	nominal range
	---	---	underrange
2 wire: 0 ... 600Ω (71h)	---	---	overrange
	0 ... 600Ω	0 ... 32767	nominal range
	---	---	underrange
2 wire: 0 ... 3000Ω (72h)	---	---	overrange
	0 ... 3000Ω	0 ... 32767	nominal range
	---	---	underrange
3 wire: 0 ... 60Ω (78h)	---	---	overrange
	0 ... 60Ω	0 ... 32767	nominal range
	---	---	underrange
3 wire: 0 ... 600Ω (79h)	---	---	overrange
	0 ... 600Ω	0 ... 32767	nominal range
	---	---	underrange
3 wire: 0 ... 3000Ω (7Ah)	---	---	overrange
	0 ... 3000Ω	0 ... 32767	nominal range
	---	---	underrange
4 wire: 0 ... 60Ω (80h)	---	---	overrange
	0 ... 60Ω	0 ... 32767	nominal range
	---	---	underrange
4 wire: 0 ... 600Ω (81h)	---	---	overrange
	0 ... 600Ω	0 ... 32767	nominal range
	---	---	underrange
4 wire: 0 ... 3000Ω (82h)	---	---	overrange
	0 ... 3000Ω	0 ... 32767	nominal range
	---	---	underrange
2 wire: 0 ... 60Ω (90h)	---	---	overrange
	0 ... 60Ω	0 ... 6000	nominal range
	---	---	underrange
2 wire: 0 ... 600Ω (91h)	---	---	overrange
	0 ... 600Ω	0 ... 6000	nominal range
	---	---	underrange
2 wire: 0 ... 3000Ω (92h)	---	---	overrange
	0 ... 3000Ω	0 ... 30000	nominal range
	---	---	underrange
3 wire: 0 ... 60Ω	---	---	overrange

Measuring range Resistance (funct. no.)	Measuring value	Signal range	Range
(98h)	0 ... 60Ω	0 ... 6000	nominal range
	---	---	underrange
3 wire: 0 ... 600Ω (99h)	---	---	overrange
	0 ... 600Ω	0 ... 6000	nominal range
3 wire: 0 ... 3000Ω (9Ah)	---	---	underrange
	0 ... 3000Ω	0 ... 30000	nominal range
4 wire: 0 ... 60Ω (A0h)	---	---	underrange
	0 ... 60Ω	0 ... 6000	nominal range
4 wire: 0 ... 600Ω (A1h)	---	---	overrange
	0 ... 600Ω	0 ... 6000	nominal range
4 wire: 0 ... 3000Ω (A2h)	---	---	underrange
	0 ... 3000Ω	0 ... 30000	nominal range
2 wire: 0 ... 60Ω (D0h)	---	---	overrange
	70.55Ω	32511	overrange
2 wire: 0 ... 600Ω (D1h)	0 ... 60Ω	0 ... 27648	nominal range
	---	---	underrange
2 wire: 0 ... 3000Ω (D2h)	705.5Ω	32511	overrange
	0 ... 600Ω	0 ... 27648	nominal range
3 wire: 0 ... 60Ω (D8h)	---	---	underrange
	3528Ω	32511	overrange
3 wire: 0 ... 600Ω (D9h)	0 ... 3000Ω	0 ... 27648	nominal range
	---	---	underrange
3 wire: 0 ... 3000Ω (DAh)	70.55Ω	32511	overrange
	0 ... 60Ω	0 ... 27648	nominal range
4 wire: 0 ... 60Ω (E0h)	---	---	underrange
	705.5Ω	32511	overrange
	0 ... 600Ω	0 ... 27648	nominal range
	---	---	underrange
	3528Ω	32511	overrange
	0 ... 3000Ω	0 ... 27648	nominal range
	---	---	underrange
	70.55Ω	32511	overrange
	0 ... 60Ω	0 ... 27648	nominal range

031-1LD80 - AI 4x16Bit R/RTD &gt; Diagnostic data

Measuring range Resistance (funct. no.)	Measuring value	Signal range	Range
	---	---	underrange
4 wire: 0 ... 600Ω (E1h)	705.5Ω	32511	overrange
	0 ... 600Ω	0 ... 27648	nominal range
	---	---	underrange
4 wire: 0 ... 3000Ω (E2h)	3528Ω	32511	overrange
	0 ... 3000Ω	0 ... 27648	nominal range
	---	---	underrange

1) Supported by 031-1BD80 from version 03V54 and 031-1LD80 from version 02V26.

The version information can be found on the outer packaging or via the website of the corresponding head module.

### 3.27.3 Diagnostic data

So this module does not support diagnostic interrupt functions, the diagnostics data serve for information about this module. On error the corresponding channel LED of the module is activated and the error is registered in the diagnostics data.

The following errors are listed in the diagnostics data:

- Error in project engineering / parameterization
- Measuring range overflow
- Measuring range underflow

DS Record set for access via CPU, PROFIBUS and PROFINET. The access happens by DS 01h. Additionally the first 4 bytes may be accessed by DS 00h.

IX Index for access via CANopen. The access happens by IX 2F01h. Additionally the first 4 bytes may be accessed by IX 2F00h.

SX Subindex for access via EtherCAT with Index 5005h.

More can be found in the according manual of your bus coupler.

Name	Bytes	Function	Default	DS	IX	SX
ERR_A	1	Diagnostic	00h	01h	2F01h	02h
MODTYP	1	Module information	15h			03h
ERR_C	1	reserved	00h			04h
ERR_D	1	Diagnostic	00h			05h
CHTYP	1	Channel type	71h			06h
NUMBIT	1	Number diagnostic bits per channel	08h			07h
NUMCH	1	Number of channels of a module	04h			08h
CHERR	1	Channel error	00h			09h
CH0ERR	1	Channel-specific error channel 0	00h			0Ah
CH1ERR	1	Channel-specific error channel 1	00h			0Bh
CH2ERR	1	Channel-specific error channel 2	00h			0Ch
CH3ERR	1	Channel-specific error channel 3	00h			0Dh
CH4ERR... CH7ERR	4	reserved	00h			0Eh ... 11h
DIAG_US	4	µs ticker	00h			13h

**ERR\_A Diagnostic**

Byte	Bit 7 ... 0
0	<ul style="list-style-type: none"> <li>■ Bit 0: set at module failure</li> <li>■ Bit 1: set at internal error</li> <li>■ Bit 2: set at external error</li> <li>■ Bit 3: set at channel error</li> <li>■ Bit 4: set at external auxiliary supply missing</li> <li>■ Bit 6 ... 5: reserved</li> <li>■ Bit 7: set at error in parametrization</li> </ul>

**MODTYP  
Module information**

Byte	Bit 7 ... 0
0	<ul style="list-style-type: none"> <li>■ Bit 3 ... 0: module class <ul style="list-style-type: none"> <li>– 0101b analog module</li> </ul> </li> <li>■ Bit 4: set at channel information present</li> <li>■ Bit 7 ... 5: reserved</li> </ul>

**ERR\_D Diagnostic**

Byte	Bit 7 ... 0
0	<ul style="list-style-type: none"> <li>■ Bit 2 ... 0: reserved</li> <li>■ Bit 3: set at internal diagnostics buffer overflow</li> <li>■ Bit 4: set at internal communication error</li> <li>■ Bit 7 ... 5: reserved</li> </ul>

**CHTYP Channel type**

Byte	Bit 7 ... 0
0	<ul style="list-style-type: none"> <li>■ Bit 6 ... 0: Channel type               <ul style="list-style-type: none"> <li>- 70h: Digital input</li> <li>- 71h: Analog input</li> <li>- 72h: Digital output</li> <li>- 73h: Analog output</li> <li>- 74h: Analog input/-output</li> <li>- 76h: Counter</li> </ul> </li> <li>■ Bit 7: reserved</li> </ul>

**NUMBIT Diagnostic bits**

Byte	Bit 7 ... 0
0	Number of diagnostic bits per channel (here 08h)

**NUMCH Channels**

Byte	Bit 7 ... 0
0	Number of channels of a module (here 04h)

**CHERR Channel error**

Byte	Bit 7 ... 0
0	<ul style="list-style-type: none"> <li>■ Bit 0: set at error in channel group 0</li> <li>■ Bit 1: set at error in channel group 1</li> <li>■ Bit 2: set at error in channel group 2</li> <li>■ Bit 3: set at error in channel group 3</li> <li>■ Bit 7 ... 4: reserved</li> </ul>

**CH0ERR ... CH3ERR  
Channel-specific**

Byte	Bit 7 ... 0
0	Channel-specific error: channel x: <ul style="list-style-type: none"> <li>■ Bit 0: set at error in project engineering/parameterization</li> <li>■ Bit 3 ... 1: reserved</li> <li>■ Bit 4: set at wire break</li> <li>■ Bit 5: reserved</li> <li>■ Bit 6: set at measuring range underflow</li> <li>■ Bit 7: set at measuring range overflow</li> </ul>

**CH4ERR ... CH7ERR  
reserved**

Byte	Bit 7 ... 0
0	reserved

**DIAG\_US  $\mu$ s ticker**

Byte	Bit 7 ... 0
0...3	Value of the $\mu$ s ticker at the moment of the diagnostic

 **$\mu$ s ticker**

In the System SLIO module there is a timer ( $\mu$ s ticker). With PowerON the timer starts counting with 0. After  $2^{32}-1\mu$ s the timer starts with 0 again.



### 3.28 031-1PAxx - AI1x 3Ph 230/400V

#### Properties

The following modules are available:

- 031-1PA00: AI1x 3Ph 230/400V 1A
- 031-1PA10: AI1x 3Ph 230/400V 5A

The modules allow the measurement of electric data for counting energy and power measurement. Here, the voltage measurement of the individual phases is done directly (or indirectly via voltage transformers) and the current measurement indirectly via current transformers. When 5A current transformers are used, energy measurement can only be performed on devices in 3-phase operation. When 1A current transformers are used, the measurement inputs can be fed from the same phase.

- Retentive storage of the energy values
- Diagnostic function
- Resolution of the measured value 24bit
- The following measurands can be found in 4-quadrant operation:
  - Voltage, current
  - Electrical power
  - Electrical work
  - Harmonics
  - Phase shift  $\cos \varphi$
  - Frequency

#### Structure

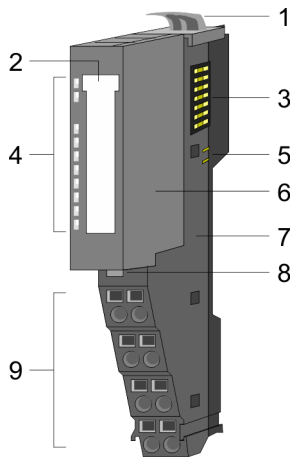

- 1 Locking lever terminal module
- 2 Labeling strip
- 3 Backplane bus
- 4 LED status indication
- 5 DC 24V power section supply
- 6 Electronic module
- 7 Terminal module
- 8 Locking lever electronic module
- 9 Terminal

031-1PAxx - AI1x 3Ph 230/400V

Status indication

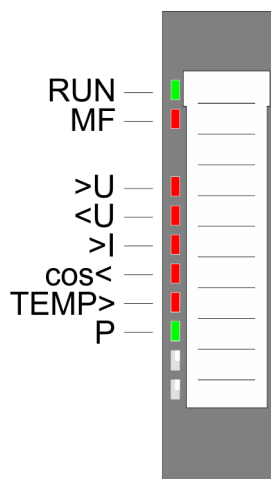

LED		Description
RUN	green	Bus communication is OK
		off: Error at bus power supply
MF	red	Module status reports an error Bus communication is not possible
		off: Module status is OK
	red	Flashes: Error in configuration <a href="#">↪ 'Trouble shooting - LEDs'...page 41</a>
>U		Voltage in the parametrized range
	red	Voltage limit value exceeded
<U		Voltage in the parametrized range
	red	Voltage limit value undershot (omitted in 1-phase operation)
>I		Current in the parametrized range
	red	Current limit value exceeded
cos<		Phase shift $\cos \varphi$ in the parametrized range
	red	Phase shift $\cos \varphi$ limit value undershot (omitted in 1-phase operation)
TEMP>		Temperature in the parametrized range
	red	Temperature limit value exceeded
P	green	P: Proportional power blinks with increasing frequency proportional to the active power at 20 pulses/Wh. The current transformer factor is not considered.



*If the limit value is exceeded, the corresponding LED lights up. After the acknowledgment of the 'status bits' the corresponding LED goes out again.*

031-1PA10 [↪ 'Status bits'...page 357](#)

031-1PA00 [↪ 'Status bits'...page 361](#)

**Pin assignment**

For wires with a core cross-section of 0.08mm<sup>2</sup> up to 1.5mm<sup>2</sup>. The measurement of current respectively voltage is done indirectly by current respectively voltage transformers.  
 → 'Connection'...page 346

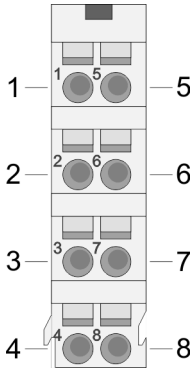

Pos.	Function	Type	Description
1	L1	I	Voltage measurement L1
2	L2	I	Voltage measurement L2
3	L3	I	Voltage measurement L3
4	N	I	Voltage measurement N
5	I <sub>L1</sub>	I	Current measurement I <sub>L1</sub>
6	I <sub>L2</sub>	I	Current measurement I <sub>L2</sub>
7	I <sub>L3</sub>	I	Current measurement I <sub>L3</sub>
8	I <sub>N</sub>	I	Current measurement I <sub>N</sub>

I: Input



**DANGER**

**Please observe safety instructions!**

With the energy measurement modules only AC voltages 230/400 V and currents can be measured. Please observe the safety instructions when handling an energy measuring module! → 'Safety precautions'...page 340

**In-/Output area**

At CPU, PROFIBUS and PROFINET the input respectively output area is embedded to the corresponding address area.

IX Index for access via CANopen with s = Subindex, depends on number and type of analog modules

SX Subindex for access via EtherCAT with Index 6000h + EtherCAT-Slot

More can be found in the according manual of your bus coupler.

**Input area**

Addr.	Name	Byte	Function	IX	SX
+0	B0 ... B3	4	Header byte 0 ... 3	6401h/s	01h
+4	D00 ... D11	12	User data input byte 0 ... 11	6401h/s+1	02h

**Output area**

Addr.	Name	Byte	Function	IX	SX
+0	B0 ... B3	4	Header byte 0 ... 3	6401h/s	01h
+4	D00 ... D11	12	User data output byte 0 ... 11	6401h/s+1	02h

→ 'Process data communication'...page 361

031-1PAxx - AI1x 3Ph 230/400V &gt; Technical data

### 3.28.1 Technical data

#### 3.28.1.1 031-1PA10

Order no.	031-1PA10
Type	SM 031 - Analog input
Module ID	0884 2880
<b>Current consumption/power loss</b>	
Current consumption from backplane bus	60 mA
Power loss	0.9 W
Rated load voltage	-
<b>Status information, alarms, diagnostics</b>	
Status display	yes
Interrupts	yes, parameterizable
Process alarm	no
Diagnostic interrupt	no
Diagnostic functions	yes, parameterizable
Diagnostics information read-out	possible
Module state	green LED
Module error display	red LED
Channel error display	-
<b>Isolation</b>	
Between channels	-
Insulation tested with	AC 2200 V
<b>Energy measurement</b>	
Number of channels for measuring	1* 1..3 phases U/I
Voltage measuring range	0..300 V each phase
Coupling voltage measurement	direct or Transformer
Current range	0..5 A each phase
Coupling current measurement	Transformer
Frequency range	46...64 Hz
Measurement accuracy	1 %

Order no.	031-1PA10
Available measurement	Active energy Temperature Frequency Voltage RMS Current RMS Active power Reactive power Apparent power Cos phi Harmonic voltage RMS Harmonic current RMS
Adjustable limits	Voltage RMS min/max Current RMS min/max Cos phi min Temperature max. Frequency min/max
<b>Datasizes</b>	
Input bytes	16
Output bytes	16
Parameter bytes	30
Diagnostic bytes	20
<b>Housing</b>	
Material	PPE / PPE GF10
Mounting	Profile rail 35 mm
<b>Mechanical data</b>	
Dimensions (WxHxD)	12.9 mm x 109 mm x 76.5 mm
Net weight	57 g
Weight including accessories	57 g
Gross weight	71 g
<b>Environmental conditions</b>	
Operating temperature	0 °C to 60 °C
Storage temperature	-25 °C to 70 °C
<b>Certifications</b>	
UL certification	yes
KC certification	yes
UKCA certification	yes
ChinaRoHS certification	yes

031-1PAxx - AI1x 3Ph 230/400V &gt; Technical data

The *Measurement accuracy*  $\pm 1\%$  is maintained from:

Measurand	Measuring range
Voltage	230 V $\pm$ 15%
Current	Current at measuring input ( $I_{L1...L3} - I_N$ ) 0 ... 5A
Cos $\varphi$	Current at measuring input ( $I_{L1...L3} - I_N$ ) $\geq$ 100mA
Power	Current at measuring input ( $I_{L1...L3} - I_N$ ) $\geq$ 2mA
Active energy	Current at measuring input ( $I_{L1...L3} - I_N$ ) $\geq$ 2mA

## 3.28.1.2 031-1PA00

Order no.	031-1PA00
Type	SM 031 - Analog input
Module ID	0882 2880
<b>Current consumption/power loss</b>	
Current consumption from backplane bus	60 mA
Power loss	0.9 W
Rated load voltage	-
<b>Status information, alarms, diagnostics</b>	
Status display	yes
Interrupts	yes, parameterizable
Process alarm	no
Diagnostic interrupt	no
Diagnostic functions	yes, parameterizable
Diagnostics information read-out	possible
Module state	green LED
Module error display	red LED
Channel error display	-
<b>Isolation</b>	
Between channels	-
Insulation tested with	AC 2200 V
<b>Energy measurement</b>	
Number of channels for measuring	1* 1..3 phases U/I
Voltage measuring range	0..300 V each phase
Coupling voltage measurement	directly
Current range	0..1 A each phase
Coupling current measurement	Transformer
Frequency range	46...64 Hz
Measurement accuracy	1 %

Order no.	031-1PA00
Available measurement	Active energy Temperature Frequency Voltage RMS Current RMS Active power Reactive power Apparent power Cos phi Harmonic voltage RMS Harmonic current RMS
Adjustable limits	Voltage RMS min/max Current RMS min/max Cos phi min Temperature max. Frequency min/max
<b>Datasizes</b>	
Input bytes	16
Output bytes	16
Parameter bytes	28
Diagnostic bytes	20
<b>Housing</b>	
Material	PPE / PPE GF10
Mounting	Profile rail 35 mm
<b>Mechanical data</b>	
Dimensions (WxHxD)	12.9 mm x 109 mm x 76.5 mm
Net weight	57 g
Weight including accessories	57 g
Gross weight	71 g
<b>Environmental conditions</b>	
Operating temperature	0 °C to 60 °C
Storage temperature	-25 °C to 70 °C
<b>Certifications</b>	
UL certification	-
KC certification	-
UKCA certification	-
ChinaRoHS certification	-

The *Measurement accuracy*  $\pm 1\%$  is maintained from:

Measurand	Measuring range
Voltage	230 V $\pm$ 15%
Current	Current at measuring input ( $I_{L1...L3} - I_N$ ) 0 ... 1A
Cos $\varphi$	Current at measuring input ( $I_{L1...L3} - I_N$ ) $\geq$ 100mA
Power	Current at measuring input ( $I_{L1...L3} - I_N$ ) $\geq$ 2mA
Active energy	Current at measuring input ( $I_{L1...L3} - I_N$ ) $\geq$ 2mA

### 3.28.2 Safety precautions

#### Please note!

With the energy measurement modules only AC voltages 230/400V and currents can be measured. Please note when using an energy measurement module the following safety instructions:



#### DANGER

##### No use in EX-zone permitted!

This device is not certified for applications in explosive environments (EX-zone)!



#### DANGER

##### Do not exchange phase and neutral connections!

Operation of the energy measuring module with phase (L1, L2 or L3) at 'N' (pin 4) is not permitted!



#### DANGER

##### Connection and module exchange only without power!

- Before you start to work on at the module for installation or maintenance, you have to disconnect it from the main power source, i.e. the power line is to be switched off (possibly remove fuses)!
- The electronic module may only be replaced on power off!
- Only properly qualified electrical staff is allowed to install, connect and/or modify electrical equipment!
- Please adhere to the national rules and regulations of the location and/or country where the units are installed (installation, safety precautions, EMC ...).



#### DANGER

##### Provide overvoltage protection!

The module is designed for overvoltage category II. Provide a corresponding overvoltage protection in the supply lines (phases and neutral) so that a hazard to persons by touching on the low voltage side is excluded.



#### DANGER

##### Provide touch protection!

Provide a touch protected wiring of the measurement including the measuring transformers and mark it with the according warnings!



**DANGER****No use with System SLIO safety modules!**

The simultaneous use of energy measurement modules and System SLIO safety modules on the backplane bus is not permitted!

**DANGER****Use only with terminal module 001-0AA40!**

Please consider that the electronic module of the energy measurement modules may only be used at the terminal module 001-0AA40!

**DANGER****Line voltage max. 400V!**

The line voltage at a voltage connector must not exceed 400V!

**DANGER****All phases of one supply grid!**

Please note that the phases to be measured must be from the same supply grid!

**CAUTION****Do not exchange current and voltage connections!**

Please note when connecting, that the current and voltage paths are not exchanged! The module will be destroyed by directly connecting one phase to a low-resistance current connector!

**CAUTION****Consider the maximum current for current transformers!**

Depending on the energy measuring module used, the following maximum current limits for the current transformers must be considered:

- 031-1PA00: max. 1A
- 031-1PA10: max. 5A

Please also consider the data sheet of your current transformer!

**CAUTION****Note characteristics of current transformers!**

- Please consider the data sheet of your current transformer!
- Some current transformer must not be operated in idle mode!
- Before commissioning your module must be connected to the secondary winding of the current transformer!

**CAUTION****Note characteristics of voltage transformers!**

- Please note that the use of a voltage transformer is only supported by the energy measurement module 031-1PA10!
- Please consider the data sheet and the safety instructions of your voltage transformer!

**Interruption of the DC 24V power section supply!**

When using energy measurement modules, the DC 24V power section supply of the further backplane bus is interrupted. By installing a power module after an energy measurement module, the DC 24V power section supply at the backplane bus can be continued.

**Reset energy counters after installation!**

As soon as the module is supplied by the DC 24V power section supply, the measurement is started and the counting of the energy counters is continued with the retentive stored counter values. The measurement is not interrupted by STOP or RESET of the CPU respectively the bus coupler. After installing the module the energy counters should be reset by CMD-Frame. → [‘CMD Frame’...page 369](#)



- As long as no parameters have been sent from the head station to the module after a power cycle, default values are transmitted by the module during a read access and not the parameters stored in the module.
- After transferring the parameters to the module the status bits are reset and the measurement is interrupted for a short time!
- Please note when at least one phase is de-activated, the parameters PF\_MIN and VRMS\_MIN are ignored and set to "0".
- On error in the parametrization the MF LED blinks and you receive an error message. → [‘Status communication’...page 363](#)

### 3.28.3 Basics

#### 3.28.3.1 Terms

##### Measurand

A *measurand* is a physical quantity that can be measured such as current, voltage or temperature.

↪ [‘Measurands - 031-1PA10’...page 353](#)

↪ [‘Measurands - 031-1PA00’...page 357](#)

##### Measured value

A *measured value* is a value of a measurand, which is determined by measurement or by calculation.

##### ID

In the module each *measurand* one *ID* is assigned. The access to the measured value of a measurand happens by means of the corresponding *ID*.

##### DS-ID

As soon as the module is supplied by the DC 24V power section supply, the measurement is started and the counting of the energy counters is continued with the retentive stored counter values. The measured values of all the measurands are stored in the module with one record set ID *DS-ID*. The following must be observed:

- All measured values with the same *DS-ID* come from the same measurement and are consistent.
- By specifying the *DS-ID* you can address the individual measured values of the same measurement.
- The *DS-ID* covers the values 1 ... 15.
- To refresh the measured values the *DS-ID* is to be incremented by 1. The value 15 must be followed by 1.
- If the *DS-ID* is incremented and there is still no new value available, the current value is returned. Here the energy measurement module reports an error. ↪ [‘Status communication’...page 363](#)
- *DS-ID* = 0 - Auto increment mode
  - With *DS-ID* = 0 there is a request with *auto increment mode*. Here the module always returns the current measured value. As soon as a new measured value is available, here the *DS-ID* is incremented by one within the values 1 ... 15. If there is no new measured value available, the *DS-ID* is not changed. Here the energy measurement module reports an error. ↪ [‘Status communication’...page 363](#)
- The uniqueness of a measured value always consists of the *ID* of the measurand and the *DS-ID*.

##### Frame

In the module you can combine some measurands to one data package (Frame), which is transferred in one step. One data package consists of 12byte user data. Considering the data length of 12 bytes, you can define the content of a frame by specifying the *ID* of the measurands. Up to 256 frames may be configured (*Frame 0* ... *Frame 255*). The following must be observed:

- The definition of *Frame 1* to *Frame 255* happens by the command *Set\_Frame*. ↪ [‘Set Frame’...page 365](#).
- *Frame 0* with the corresponding measurands can exclusively be specified by the parametrization. ↪ [‘Parameter data’...page 347](#)
- With telegram type *Zero Frame* the data package of Frame 0 can be accessed. After the start-up of the module there are automatic *Zero Frame* requests as long as the process data communication comes from the head module. ↪ [‘Read Frame’...page 368](#)

**FR-ID** When defining frames by means of 'Set Frame', via the *FR-ID* these are assigned to a number between 0 ... 255. By specifying the *FR-ID* you can request the corresponding frame.

**Data type** In the following the data types are listed, which are used in the module. The length is to be considered particularly by the definition of *Frames*.

Data type	Length in byte	Description
UINT_8	1	Integer 8bit
UINT_16	2	Integer 16bit
UINT_32	4	Integer 32bit
INT_8	1	Signed integer 8bit
INT_16	2	Signed integer 16bit
INT_32	4	Signed integer 32bit
FLOAT	4	32bit floating point IEEE 754

### 3.28.3.2 Principle of measurement

#### Calculation of the effective values of current and voltage

- For 3phase AC low-voltage networks the nominal voltage corresponds to the RMS voltage  $U_{RMS}$  e.g.  $230V_{RMS}$  as star voltage between one of the three phase conductors (L1, L2 or L3) and the neutral conductor N.
- The module is used for detecting the current and voltage values and the energy values of all 3 phases. Here, the module measures the real effective value (True RMS) of voltages and currents.
- The sampling rate of the digitally processed measured values is 2.7 kHz. The time interval for the calculation of the actual values is 200 ms. This results in an evaluation window of the measured data of 540 measured values, which can be requested at any time.

#### Voltage measurement

##### Averaging

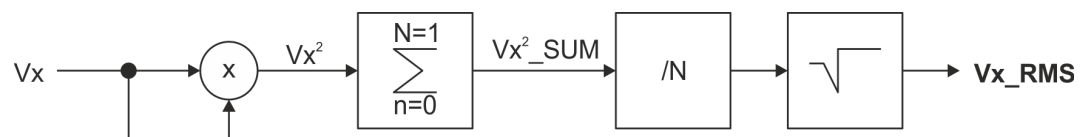

1. The square of the currently measured voltage  $V_x$  is calculated.  
➔  $V_x^2$
2. The sum of  $V_x^2$  is calculated via the time interval  $n = 0 \dots n = N-1$ .  
➔  $V_x^2\_SUM$
3.  $V_x^2\_SUM$  is divided by  $N$  the number of measurements.
4. From the result of the division, the square root is drawn.  
➔ **Average  $V_x\_RMS$**

#### Current measurement

For current measurement you have to use external current transformers!

**CAUTION****Consider the maximum current for current transformers!**

Depending on the energy measuring module used, the following maximum current limits for the current transformers must be considered:

- 031-1PA00: max. 1A
- 031-1PA10: max. 5A

Please also consider the data sheet of your current transformer!

**CAUTION****Note characteristics of current transformers!**

- Please consider the data sheet of your current transformer!
- Some current transformer must not be operated in idle mode!
- Before commissioning your module must be connected to the secondary winding of the current transformer!



- *Please note that the overall accuracy of the assembly of measuring module and current transformers depends on the accuracy class of the transformers.*
- *The transformer factor is retentive stored and taken into account while counting.*
- *A change of the transformer factor is taken immediately recognized. Current counter values are not changed, new values are added.*
- *When the transformer factor was changed, current counter values are not changed, new values are added considering the new factor.*

**Calculating power, energy**

To calculate the effective power P, each time synchronous sample value of the currents and voltages are used. In this case, phase shifts between the currents and voltages are considered. The energy is calculated from integration of the power by time.

**For the power is valid:**

- *Positive sign (+): Consumed respectively received power*
- *Negative sign (-): Fed in power*

**Determine frequency**

The *frequency* of the phases is determined by a zero crossing detection of the sampled signals and calculating from the frequency.

**Apparent power**

$$S = U \times I$$

The *apparent power* S is calculated from the product of effective current  $I_{eff}$  and *effective voltage*  $U_{eff}$ . With the apparent power you get the total power of a power grid.

**Reactive power**

$$Q = U \times I \times \sin \varphi$$

With AC voltage supplied, any electrical device generates an electromagnetic field. By AC voltage, the magnetic field is regularly built and removed. Because the power to build a field is returned to the grid as it is being removed, this power is called "reactive power". Reactive power oscillates between consumer and producer generator and pollutes the power grids. The reactive power is the product of current and voltage at a reactance. Reactances are all types of coils and capacitors. If these are connected to an AC voltage, they can absorb energy and release it phase-shifted as reactive power. The reactive

power results of the phase-shift between current and voltage of the inductance respectively capacitance. With a pure ohmic resistance current and voltage are in the same phase, therefore, a purely resistive resistor has no reactive component.



The formula  $Q = U \times I \times \sin \varphi$  applies only to purely sinusoidal currents.

#### Active power

$$P = U \times I \times \cos \varphi$$

The *active power*  $P$  is the effectively used power. This is the part without phase shift between voltage and current and refers to a resistive load.

#### Calculation of the power factor $\cos \varphi$ (phi)

In real networks energy consumers / producers typically are not purely ohmic. There is a phase shift between current and voltage. The  $\cos \varphi$  is a measure of the phase shift between current and voltage of the basic frequency of the corresponding phase. The *total*  $\cos \varphi$  is calculated by dividing *total active power*  $P$  and *total apparent power*  $S$ .

#### Harmonics

Harmonics are oscillations of the voltages and currents, whose frequency is an integer multiple of the basic frequency. The 1. harmonic is the basic frequency or mains frequency, nominally 50Hz or 60Hz. The level of harmonics is a measure for the network quality. Harmonics or harmonic oscillations are caused by equipment with non-linear characteristics such as transformers, fluorescent lamps and power electronic equipment such as rectifiers and thyristors. The non-sinus-shaped currents of these consumers cause the net interference voltages, which distorts the nominal line voltage. During parametrization you can specify the level of the harmonic. With this frequency the 'harmonic' current and voltage values are filtered.

### 3.28.4 Connection



#### DANGER

Please observe safety instructions!

With the energy measurement modules only AC voltages 230/400 V and currents can be measured. Please observe the safety instructions when handling an energy measuring module! → 'Safety precautions'...page 340

**Connection via current transformer**

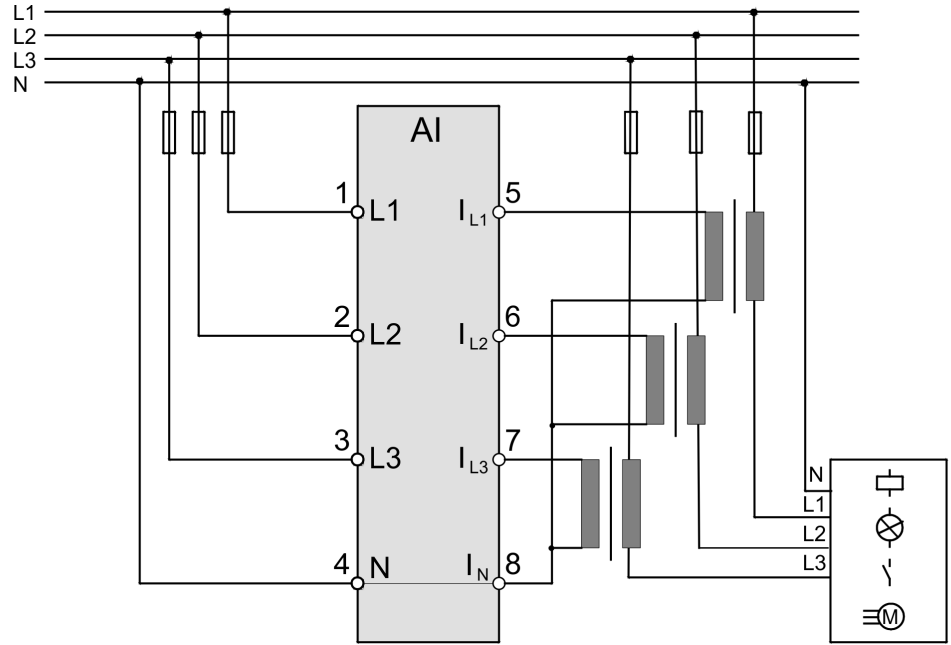
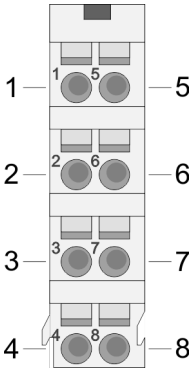

**Connection via current- /voltage transformer**

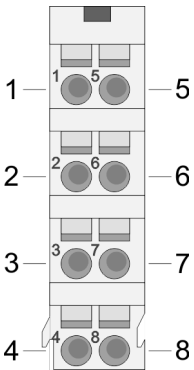

Please note that the use of a voltage transformer is only supported by the energy measurement module 031-1PA10!

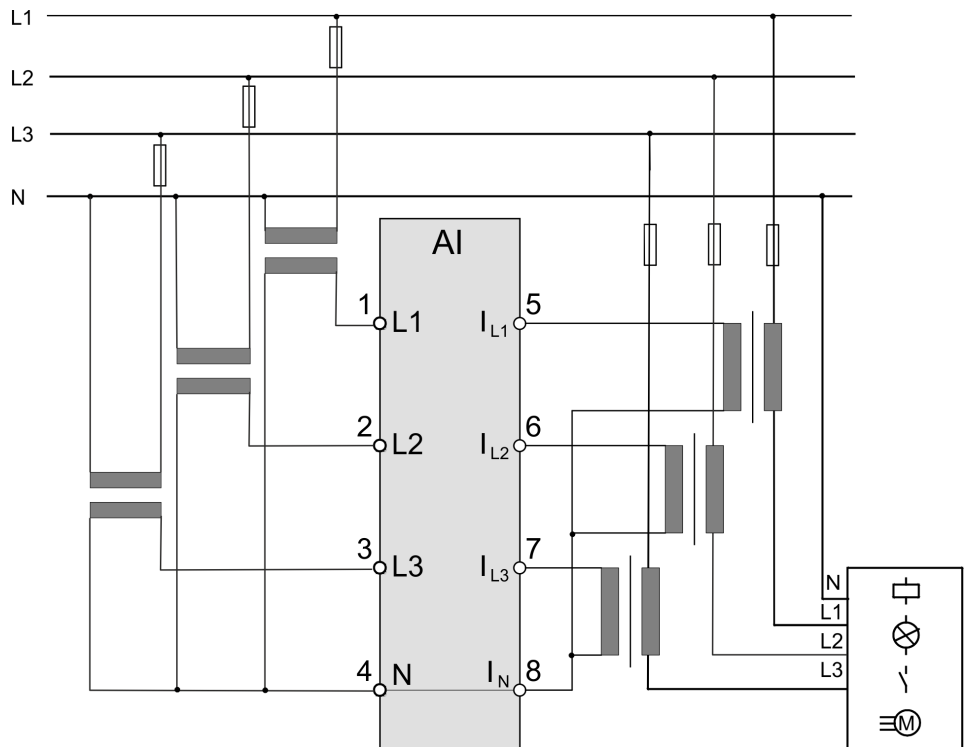

**3.28.5 Parameter data**

**3.28.5.1 Parameter - 031-1PA10**

- DS Record set for access via CPU, PROFIBUS and PROFINET
  - IX Index for access via CANopen
  - SX Subindex for access via EtherCAT with Index 3100h + EtherCAT-Slot
- More can be found in the according manual of your bus coupler.

IDx	Name	Data type	Description	Default (dec.)	DS	IX	SX
1	CFG	UINT_8	Choice of phases and data formats	0	80h	3100h	01h
2	F0V1	UINT_8	Frame 0: Value 1 (IDx)	1	81h	3101h	02h
3	F0V2	UINT_8	Frame 0: Value 2 (IDx)	9		3102h	03h
4	F0V3	UINT_8	Frame 0: Value 3 (IDx)	13		3103h	04h
5	F0V4	UINT_8	Frame 0: Value 4 (IDx)	0		3104h	05h
6	F0V5	UINT_8	Frame 0: Value 5 (IDx)	0		3105h	06h
102	IRMS_MAX <sup>1</sup>	UINT_32	Current upper limit [mA] Range of values: 0 ... 25000000	0 <sup>1</sup>	82h	3106h.. 3109h	07h
104	VRMS_MAX	UINT_16	Voltage upper limit [V] Range of values: 0 ... 30000	260	83h	310Ah 310Bh	08h
105	VRMS_MIN	UINT_16	Voltage lower limit [V] Range of values: 0 ... 30000	200		310Ch.. 310Dh	09h
106	PF_MIN	UINT_8	Cos φ lower limit [0.01] Range of values: 0 ... 100	30		84h	310Eh..
107	T_MAX	UINT_16	Temperature upper limit [0.01 °C] Range of values: 0 ... 20000	7000	85h	310Fh.. 3110h	0Bh
108	F_MAX	UINT_16	Frequency upper limit [0.01 Hz] Range of values: 0 ... 20000	5100		3111h.. 3112h	0Ch
109	F_MIN	UINT_16	Frequency lower limit [0.01 Hz] Range of values: 0 ... 20000	4900		3113h.. 3114h	0Dh
111	WANDLER_I	UINT_16	Current transformer factor Range of values: 1 ... 5000	1		3115h.. 3116h	0Eh
112	WANDLER_U	UINT_16	Voltage transformer factor Range of values: 1 ... 300	1		3117h.. 3118h	0Fh
113	HARM	UINT_8	Harmonic number → <a href="#">‘Harmonics’...page 346</a> Range of values: 1 ... 30	1	86h	3119h	10h

The parameters are transferred in big-endian format (byte order: high byte, low byte).

1) Parameter is to be defined. (value: >0).



- As long as no parameters have been sent from the head station to the module after a power cycle, default values are transmitted by the module during a read access and not the parameters stored in the module.
- After transferring the parameters to the module the status bits are reset and the measurement is interrupted for a short time!
- Please note when at least one phase is de-activated, the parameters PF\_MIN and VRMS\_MIN are ignored and set to "0".
- On error in the parametrization the MF LED blinks and you receive an error message. → [‘Status communication’...page 363](#)



## Data type

[↔ 'Data type'...page 344](#)

## CFG

Bit	Name	Description	Default
0	reserved		0
1	Write Protect <sup>1</sup>	Write protection bit for parameterization via Web server <ul style="list-style-type: none"> <li>■ 0: Write Protect de-activated</li> <li>■ 1: Write Protect activated</li> </ul> Please see the following note!	1 <sup>1</sup>
2	reserved		0
3	Phase 1	Measurement phase L1 <ul style="list-style-type: none"> <li>■ 0: Measurement is activated</li> <li>■ 1: Measurement is de-activated</li> </ul>	0
4	Phase 2	Measurement phase L2 <ul style="list-style-type: none"> <li>■ 0: Measurement is activated</li> <li>■ 1: Measurement is de-activated</li> </ul>	0
5	Phase 3	Measurement phase L3 <ul style="list-style-type: none"> <li>■ 0: Measurement is activated</li> <li>■ 1: Measurement is de-activated</li> </ul>	0
6	Data type	Data type of the measured values in the user data <ul style="list-style-type: none"> <li>■ 0: Integer (INT)</li> <li>■ 1: 32bit floating point (FLOAT) DIN IEEE 754</li> </ul>	0
7	Byteorder	Data type of the measured values in the user data <ul style="list-style-type: none"> <li>■ 0: Big-Endian: Byte order: high byte, low byte</li> <li>■ 1: Little-Endian: Byte order: low byte, high byte</li> </ul>	0

1) Access to the 'Write Protect' parameter is only possible via the Web server of the head module (not via GSD or GSDML).



### 1) Write Protect

*The parameter 'Write Protect' is only relevant, if the module is connected to a head module with an integrated Web server. If the module is parameterized via the Web server 'Write Protect' must be set to "0", otherwise the changed parameters will not be used!*

**F0V1 ... F0V5**

In the module you can combine some measurands to one data package (Frame), which is transferred in one step. → [‘Frame’...page 343](#)

By specifying the *ID* of the corresponding measurand, via *F0V1 ... F0V5* the data areas of Frame 0 can be defined. Please note that here the user data length of 12 bytes is not exceeded. → [‘Measurands - 031-1PA10’...page 353](#)

- Range of values: 0 ... 41
- Default:
  - F0V1: 1 (active energy consumer)
  - F0V2: 9 (total active power)
  - F0V3: 13 (total cos φ)
  - F0V4: 0
  - F0V5: 0

**3.28.5.2 Parameter - 031-1PA00**

DS Record set for access via CPU, PROFIBUS and PROFINET

IX Index for access via CANopen

SX Subindex for access via EtherCAT with Index 3100h + EtherCAT-Slot

More can be found in the according manual of your bus coupler.

IDx	Name	Data type	Description	Default (dec.)	DS	IX	SX
1	CFG	UINT_8	Choice of phases and data formats	0	80h	3100h	01h
2	F0V1	UINT_8	Frame 0: Value 1 (IDx)	1	81h	3101h	02h
3	F0V2	UINT_8	Frame 0: Value 2 (IDx)	9		3102h	03h
4	F0V3	UINT_8	Frame 0: Value 3 (IDx)	13		3103h	04h
5	F0V4	UINT_8	Frame 0: Value 4 (IDx)	0		3104h	05h
6	F0V5	UINT_8	Frame 0: Value 5 (IDx)	0		3105h	06h
102	IRMS_MAX <sup>1</sup>	UINT_32	Current upper limit [mA] Range of values: 0 ... 25000000	0 <sup>1</sup>	82h	3106h.. 3109h	07h
104	VRMS_MAX	UINT_16	Voltage upper limit [V] Range of values: 0 ... 500	260	83h	310Ah 310Bh	08h
105	VRMS_MIN	UINT_16	Voltage lower limit [V] Range of values: 0 ... 500	200		310Ch.. 310Dh	09h
106	PF_MIN	UINT_8	Cos φ lower limit [0.01] Range of values: 0 ... 100	30	84h	310Eh..	0Ah
107	T_MAX	UINT_16	Temperature upper limit [0.01 °C] Range of values: 0 ... 20000	7000	85h	310Fh.. 3110h	0Bh
108	F_MAX	UINT_16	Frequency upper limit [0.01 Hz] Range of values: 0 ... 20000	5100		3111h.. 3112h	0Ch
109	F_MIN	UINT_16	Frequency lower limit [0.01 Hz] Range of values: 0 ... 20000	4900		3113h.. 3114h	0Dh

IDx	Name	Data type	Description	Default (dec.)	DS	IX	SX
111	WANDLER_I	UINT_16	Current transformer factor Range of values: 1 ... 5000	1		3115h.. 3116h	0Eh
112	HARM	UINT_8	Harmonic number → <i>'Harmonics'...</i> page 346 Range of values: 1 ... 30	1	86h	3117h	0Fh

The parameters are transferred in big-endian format (byte order: high byte, low byte).

1) Parameter is to be defined. (value: >0).



- As long as no parameters have been sent from the head station to the module after a power cycle, default values are transmitted by the module during a read access and not the parameters stored in the module.
- After transferring the parameters to the module the status bits are reset and the measurement is interrupted for a short time!
- Please note when at least one phase is de-activated, the parameters PF\_MIN and VRMS\_MIN are ignored and set to "0".
- On error in the parametrization the MF LED blinks and you receive an error message. → *'Status communication'...*page 363

## Data type

→ *'Data type'...*page 344

## CFG

Bit	Name	Description	Default
0	reserved		0
1	Write Protect <sup>1</sup>	Write protection bit for parameterization via Web server <ul style="list-style-type: none"> <li>■ 0: Write Protect de-activated</li> <li>■ 1: Write Protect activated</li> </ul> Please see the following note!	1 <sup>1</sup>
2	reserved		0
3	Phase 1	Measurement phase L1 <ul style="list-style-type: none"> <li>■ 0: Measurement is activated</li> <li>■ 1: Measurement is de-activated</li> </ul>	1
4	Phase 2	Measurement phase L2 <ul style="list-style-type: none"> <li>■ 0: Measurement is activated</li> <li>■ 1: Measurement is de-activated</li> </ul>	1
5	Phase 3	Measurement phase L3 <ul style="list-style-type: none"> <li>■ 0: Measurement is activated</li> <li>■ 1: Measurement is de-activated</li> </ul>	1
6	Data type	Data type of the measured values in the user data <ul style="list-style-type: none"> <li>■ 0: Integer (INT)</li> <li>■ 1: 32bit floating point (FLOAT) DIN IEEE 754</li> </ul>	0
7	Byteorder	Data type of the measured values in the user data <ul style="list-style-type: none"> <li>■ 0: Big-Endian: Byte order: high byte, low byte</li> <li>■ 1: Little-Endian: Byte order: low byte, high byte</li> </ul>	0

1) Access to the 'Write Protect' parameter is only possible via the Web server of the head module (not via GSD or GSDML).



### <sup>1)</sup> Write Protect

The parameter 'Write Protect' is only relevant, if the module is connected to a head module with an integrated Web server. If the module is parameterized via the Web server 'Write Protect' must be set to "0", otherwise the changed parameters will not be used!

## F0V1 ... F0V5

In the module you can combine some measurands to one data package (Frame), which is transferred in one step. → ['Frame'...page 343](#)

By specifying the *ID* of the corresponding measurand, via *F0V1 ... F0V5* the data areas of Frame 0 can be defined. Please note that here the user data length of 12 bytes is not exceeded. → ['Measurands - 031-1PA00'...page 357](#)

- Range of values: 0 ... 41
- Default:
  - F0V1: 1 (active energy consumer)
  - F0V2: 9 (total active power)
  - F0V3: 13 (total cos φ)
  - F0V4: 0
  - F0V5: 0

### 3.28.6 Measurands

#### 3.28.6.1 Measurands - 031-1PA10

##### Data type INT

ID	Description	Data type	Unit	Min. value	Max. value
1	Counter: Active energy consumer	UINT_32	1Wh <sup>1</sup>	0	4 294 967 295
2	Counter: Active energy producer	UINT_32	1Wh <sup>1</sup>	0	4 294 967 295
3	Counter: Active energy L1 consumer	UINT_32	1Wh <sup>1</sup>	0	4 294 967 295
4	Counter: Active energy L1 producer	UINT_32	1Wh <sup>1</sup>	0	4 294 967 295
5	Counter: Active energy L2 consumer	UINT_32	1Wh <sup>1</sup>	0	4 294 967 295
6	Counter: Active energy L2 producer	UINT_32	1Wh <sup>1</sup>	0	4 294 967 295
7	Counter: Active energy L3 consumer	UINT_32	1Wh <sup>1</sup>	0	4 294 967 295
8	Counter: Active energy L3 producer	UINT_32	1Wh <sup>1</sup>	0	4 294 967 295
9	Total active power	INT_32	1mW	-2 147 483 647	2 147 483 647
10	Total reactive power	INT_32	1mW	-2 147 483 647	2 147 483 647
11	Total apparent power	INT_32	1mW	-2 147 483 647	2 147 483 647
12	Frequency	UINT_16	0.01Hz	4600	6400
13	Total Cos $\varphi^2$	INT_8	0.01	-100	100
14	Temperature	INT_16	0.01°C	-2500	8500
15	Active power L1	INT_32	1mW	-715 827 882	715 827 882
16	Reactive power L1	INT_32	1mW	-715 827 882	715 827 882
17	Total power L1	INT_32	1mW	-715 827 882	715 827 882
18	Voltage L1	UINT_32	1mV	0	30 000 000
19	Current L1	UINT_32	1mA	0	25 000 000
20	Cos $\varphi$ L1 <sup>2</sup>	INT_8	0.01	-100	100
21	Harmonic voltage L1	UINT_32	1mV	0	30 000 000
22	Harmonic current L1	UINT_32	1mA	0	25 000 000
23	Active power L2	INT_32	1mW	-715 827 882	715 827 882
24	Reactive power L2	INT_32	1mW	-715 827 882	715 827 882
25	Total power L2	INT_32	1mW	-715 827 882	715 827 882
26	Voltage L2	UINT_32	1mV	0	30 000 000
27	Current L2	UINT_32	1mA	0	25 000 000
28	Cos $\varphi$ L2 <sup>2</sup>	INT_8	0.01	-100	100
29	Harmonic voltage L2	UINT_32	1mV	0	30 000 000
30	Harmonic current L2	UINT_32	1mA	0	25 000 000
31	Active power L3	INT_32	1mW	-715 827 882	715 827 882
32	Reactive power L3	INT_32	1mW	-715 827 882	715 827 882
33	Total power L3	INT_32	1mW	-715 827 882	715 827 882
34	Voltage L3	UINT_32	1mV	0	30 000 000
35	Current L3	UINT_32	1mA	0	25 000 000

ID	Description	Data type	Unit	Min. value	Max. value
36	Cos $\varphi$ L3 <sup>2</sup>	INT_8	0.01	-100	100
37	Harmonic voltage L3	UINT_32	1mV	0	30 000 000
38	Harmonic current L3	UINT_32	1mA	0	25 000 000
39	Overflow energy meter consumer Is incremented by 1 in case of overflow of the energy meter (ID = 1)	UINT_32		0	4 294 967 295
40	Overflow energy meter producer Is incremented by 1 in case of overflow of the energy meter (ID = 2)	UINT_32		0	4 294 967 295
41	Status bits → <a href="#">‘Status bits’...page 357</a>	UINT_32			

1) The display resolution of the energy meter is  $1\text{Wh} \times \text{WANDLER}_I \times \text{WANDLER}_U$  (current transformer factor x voltage transformer factor). → [‘Parameter - 031-1PA10’...page 347](#)

2) The measuring accuracy of the Cos  $\varphi$  is maintained from a minimum current of  $100\text{mA} \times \text{WANDLER}_I$  (current transformer factor).

**Tolerance**

See Technical data → [‘031-1PA10’...page 336](#)

**ID**

Each measurand one *ID* is assigned. The access to the measured value of a measurand happens by means of the corresponding *ID*.

**Data type**

→ [‘Data type’...page 344](#)

**Max. Total power**

- The max. Total power for 3 phases is
  - $\pm 2\,147\,483\,647\text{mW}$  (INT\_32)
- $3 \times U_{\text{max}} \times \text{WANDLER}_U \times I_{\text{max}} \times \text{WANDLER}_I$

If the Total power is exceeded by  $\pm 2\,147\,483\,647\text{mW}$  (INT\_32), the max value is output.

**Overflow energy meter**

- 0xXX112233
  - XX: not used
  - 11: Overflow phase L1
  - 22: Overflow phase L2
  - 33: Overflow phase L3

## Measurands Data type FLOAT

ID	Description	Data type	Unit	Min. value	Max. value
1	Counter: Active energy consumer	FLOAT	1Wh <sup>1</sup>	0	5.497558 x 10 <sup>8</sup>
2	Counter: Active energy producer	FLOAT	1Wh <sup>1</sup>	0	5.497558 x 10 <sup>8</sup>
3	Counter: Active energy L1 consumer	FLOAT	1Wh <sup>1</sup>	0	5.497558 x 10 <sup>8</sup>
4	Counter: Active energy L1 producer	FLOAT	1Wh <sup>1</sup>	0	5.497558 x 10 <sup>8</sup>
5	Counter: Active energy L2 consumer	FLOAT	1Wh <sup>1</sup>	0	5.497558 x 10 <sup>8</sup>
6	Counter: Active energy L2 producer	FLOAT	1Wh <sup>1</sup>	0	5.497558 x 10 <sup>8</sup>
7	Counter: Active energy L3 consumer	FLOAT	1Wh <sup>1</sup>	0	5.497558 x 10 <sup>8</sup>
8	Counter: Active energy L3 producer	FLOAT	1Wh <sup>1</sup>	0	5.497558 x 10 <sup>8</sup>
9	Total active power	FLOAT	1W	-2.147484 x 10 <sup>6</sup>	2.147484 x 10 <sup>6</sup>
10	Total reactive power	FLOAT	1W	-2.147484 x 10 <sup>6</sup>	2.147484 x 10 <sup>6</sup>
11	Total apparent power	FLOAT	1W	-2.147484 x 10 <sup>6</sup>	2.147484 x 10 <sup>6</sup>
12	Frequency	FLOAT	10Hz	4.600 x 10 <sup>3</sup>	6.400 x 10 <sup>3</sup>
13	Total Cos $\varphi^2$	FLOAT	10	-0.01	1.0
14	Temperature	FLOAT	10°C	-2.500 x 10 <sup>3</sup>	8.500 x 10 <sup>3</sup>
15	Active power L1	FLOAT	1W	-7.158278 x 10 <sup>5</sup>	7.158278 x 10 <sup>5</sup>
16	Reactive power L1	FLOAT	1W	-7.158278 x 10 <sup>5</sup>	7.158278 x 10 <sup>5</sup>
17	Total power L1	FLOAT	1W	-7.158278 x 10 <sup>5</sup>	7.158278 x 10 <sup>5</sup>
18	Voltage L1	FLOAT	1V	0	3.0 x 10 <sup>4</sup>
19	Current L1	FLOAT	1A	0	2.5 x 10 <sup>4</sup>
20	Cos $\varphi$ L1 <sup>2</sup>	FLOAT	10	-0.01	1.0
21	Harmonic voltage L1	FLOAT	1V	0	3.0 x 10 <sup>4</sup>
22	Harmonic current L1	FLOAT	1A	0	2.5 x 10 <sup>4</sup>
23	Active power L2	FLOAT	1W	-7.158278 x 10 <sup>5</sup>	7.158278 x 10 <sup>5</sup>
24	Reactive power L2	FLOAT	1W	-7.158278 x 10 <sup>5</sup>	7.158278 x 10 <sup>5</sup>
25	Total power L2	FLOAT	1W	-7.158278 x 10 <sup>5</sup>	7.158278 x 10 <sup>5</sup>
26	Voltage L2	FLOAT	1V	0	3.0 x 10 <sup>4</sup>
27	Current L2	FLOAT	1A	0	2.5 x 10 <sup>4</sup>
28	Cos $\varphi$ L2 <sup>2</sup>	FLOAT	10	-0.01	1.0
29	Harmonic voltage L2	FLOAT	1V	0	3.0 x 10 <sup>4</sup>
30	Harmonic current L2	FLOAT	1A	0	2.5 x 10 <sup>4</sup>
31	Active power L3	FLOAT	1W	-7.158278 x 10 <sup>5</sup>	7.158278 x 10 <sup>5</sup>
32	Reactive power L3	FLOAT	1W	-7.158278 x 10 <sup>5</sup>	7.158278 x 10 <sup>5</sup>
33	Total power L3	FLOAT	1W	-7.158278 x 10 <sup>5</sup>	7.158278 x 10 <sup>5</sup>
34	Voltage L3	FLOAT	1V	0	3.0 x 10 <sup>4</sup>
35	Current L3	FLOAT	1A	0	2.5 x 10 <sup>4</sup>
36	Cos $\varphi$ L3 <sup>2</sup>	FLOAT	10	-0.01	1.0
37	Harmonic voltage L3	FLOAT	1V	0	3.0 x 10 <sup>4</sup>

031-1PAxx - AI1x 3Ph 230/400V &gt; Measurands

ID	Description	Data type	Unit	Min. value	Max. value
38	Harmonic current L3	FLOAT	1A	0	$2.5 \times 10^4$
39	Overflow energy meter consumer Is incremented by 1 in case of overflow of the energy meter (ID = 1)	FLOAT		Overflow energy meter is at FLOAT not effective	
40	Overflow energy meter producer Is incremented by 1 in case of overflow of the energy meter (ID = 2)	FLOAT		Overflow energy meter is at FLOAT not effective	
41	Status bits → <a href="#">‘Status bits’...page 357</a>	UINT_32			

1) The display resolution of the energy meter is  $1\text{Wh} \times \text{WANDLER\_I} \times \text{WANDLER\_U}$  (current transformer factor x voltage transformer factor). → [‘Parameter - 031-1PA10’...page 347](#)

2) The measuring accuracy of the  $\text{Cos } \varphi$  is maintained from a minimum current of  $100\text{mA} \times \text{WANDLER\_I}$  (current transformer factor).

**Tolerance**See Technical data → [‘031-1PA10’...page 336](#)**ID**Each measurand one *ID* is assigned. The access to the measured value of a measurand happens by means of the corresponding *ID*.**Data type**→ [‘Data type’...page 344](#)**Max. Total power**

- The max. Total power for 3 phases is
  - $\pm 2.147484 \times 10^6\text{W}$  (FLOAT)
- $3 * U_{\text{max}} * \text{WANDLER\_U} * I_{\text{max}} * \text{WANDLER\_I}$

If the Total power is exceeded by  $\pm 2.147484 \times 10^6\text{W}$  (FLOAT), the max value is output.



**Status bits**

With *status bits* you get information about limit violations.

- The limit values can be defined via the parametrization. → '[Parameter - 031-1PA10'...page 347](#)
- The *status bits* are refreshed together with the other measurement values, as soon as the *DS-ID* is incremented.
- Set bits of *status bits* remain set as long as they are acknowledged. → '[CMD Frame'...page 369](#).
  - By acknowledging the *status bits*, the corresponding LEDs for exceeding the limit value will be deleted again.
- Byte order: high byte, low byte (at big endian)

Byte	Description
0	0: de-activated, 1: activated <ul style="list-style-type: none"> <li>■ Bit 0: Voltage at phase L2 below limit value (L2: VRMS_MIN)</li> <li>■ Bit 1: Voltage at phase L3 below limit value (L3: VRMS_MIN)</li> <li>■ Bit 2: Voltage at phase L1 above limit value (L1: VRMS_MAX)</li> <li>■ Bit 3: Voltage at phase L2 above limit value (L2: VRMS_MAX)</li> <li>■ Bit 4: Voltage at phase L3 above limit value (L3: VRMS_MAX)</li> <li>■ Bit 5: Temperature above limit value (T_MAX)</li> <li>■ Bit 6: Frequency below limit value (F_MIN)</li> <li>■ Bit 7: Frequency above limit value (F_MAX)</li> </ul>
1	0: de-activated, 1: activated <ul style="list-style-type: none"> <li>■ Bit 0               <ul style="list-style-type: none"> <li>– 0: deleted via CMD Frame (0x04)</li> <li>– 1: if there was a RESET of the module. This happens after PowerON.</li> </ul> </li> <li>■ Bit 1: Current at phase L1 above limit value (L1: IRMS_MAX)</li> <li>■ Bit 2: Current at phase L2 above limit value (L2: IRMS_MAX)</li> <li>■ Bit 3: Current at phase L3 above limit value (L3: IRMS_MAX)</li> <li>■ Bit 4: Efficiency <math>\cos \varphi</math> phase L1 below limit value (L1: PF_MIN)</li> <li>■ Bit 5: Efficiency <math>\cos \varphi</math> phase L2 below limit value (L2: PF_MIN)</li> <li>■ Bit 6: Efficiency <math>\cos \varphi</math> phase L3 below limit value (L3: PF_MIN)</li> <li>■ Bit 7: Voltage at phase L1 below limit value (L1: VRMS_MIN)</li> </ul>
2, 3	reserved

**3.28.6.2 Measurands - 031-1PA00****Data type INT**

ID	Description	Data type	Unit	Min. value	Max. value
1	Counter: Active energy consumer	UINT_32	1Wh <sup>1</sup>	0	4 294 967 295
2	Counter: Active energy producer	UINT_32	1Wh <sup>1</sup>	0	4 294 967 295
3	Counter: Active energy L1 consumer	UINT_32	1Wh <sup>1</sup>	0	4 294 967 295
4	Counter: Active energy L1 producer	UINT_32	1Wh <sup>1</sup>	0	4 294 967 295
5	Counter: Active energy L2 consumer	UINT_32	1Wh <sup>1</sup>	0	4 294 967 295
6	Counter: Active energy L2 producer	UINT_32	1Wh <sup>1</sup>	0	4 294 967 295
7	Counter: Active energy L3 consumer	UINT_32	1Wh <sup>1</sup>	0	4 294 967 295
8	Counter: Active energy L3 producer	UINT_32	1Wh <sup>1</sup>	0	4 294 967 295

031-1PAxx - AI1x 3Ph 230/400V &gt; Measurands

ID	Description	Data type	Unit	Min. value	Max. value
9	Total active power	INT_32	1mW	-3 750 000	3 750 000
10	Total reactive power	INT_32	1mW	-3 750 000	3 750 000
11	Total apparent power	INT_32	1mW	-3 750 000	3 750 000
12	Frequency	UINT_16	0.01Hz	4600	6400
13	Total Cos $\varphi^2$	INT_8	0.01	-100	100
14	Temperature	INT_16	0.01°C	-2500	8500
15	Active power L1	INT_32	1mW	-1 250 000	1 250 000
16	Reactive power L1	INT_32	1mW	-1 250 000	1 250 000
17	Total power L1	INT_32	1mW	-1 250 000	1 250 000
18	Voltage L1	UINT_32	1mV	0	300 000
19	Current L1	UINT_32	1mA	0	5 000 000
20	Cos $\varphi$ L1 <sup>2</sup>	INT_8	0.01	-100	100
21	Harmonic voltage L1	UINT_32	1mV	0	300 000
22	Harmonic current L1	UINT_32	1mA	0	5 000 000
23	Active power L2	INT_32	1mW	-1 250 000	1 250 000
24	Reactive power L2	INT_32	1mW	-1 250 000	1 250 000
25	Total power L2	INT_32	1mW	-1 250 000	1 250 000
26	Voltage L2	UINT_32	1mV	0	300 000
27	Current L2	UINT_32	1mA	0	5 000 000
28	Cos $\varphi$ L2 <sup>2</sup>	INT_8	0.01	-100	100
29	Harmonic voltage L2	UINT_32	1mV	0	300 000
30	Harmonic current L2	UINT_32	1mA	0	5 000 000
31	Active power L3	INT_32	1mW	-1 250 000	1 250 000
32	Reactive power L3	INT_32	1mW	-1 250 000	1 250 000
33	Total power L3	INT_32	1mW	-1 250 000	1 250 000
34	Voltage L3	UINT_32	1mV	0	300 000
35	Current L3	UINT_32	1mA	0	5 000 000
36	Cos $\varphi$ L3 <sup>2</sup>	INT_8	0.01	-100	100
37	Harmonic voltage L3	UINT_32	1mV	0	300 000
38	Harmonic current L3	UINT_32	1mA	0	5 000 000
39	Overflow energy meter Is incremented by 1 in case of overflow of the energy meter (ID = 1)	UINT_32		0	4 294 967 295
40	Overflow energy meter Is incremented by 1 in case of overflow of the energy meter (ID = 2)	UINT_32		0	4 294 967 295
41	Status bits → <a href="#">‘Status bits’...page 361</a>	UINT_32			

1) The display resolution of the energy meter is 1Wh x *WANDLER\_I* (current transformer factor). → [‘Parameter - 031-1PA00’...page 350](#)

2) The measuring accuracy of the Cos  $\varphi$  is maintained from a minimum current of 5mA x *WANDLER\_I* (current transformer factor).

<b>Tolerance</b>	See Technical data → <a href="#">‘031-1PA00’...page 338</a>
<b>ID</b>	Each measurand one <i>ID</i> is assigned. The access to the measured value of a measurand happens by means of the corresponding <i>ID</i> .
<b>Data type</b>	→ <a href="#">‘Data type’...page 344</a>
<b>Max. Total power</b>	<ul style="list-style-type: none"> <li>■ The max. Total power for 3 phases is             <ul style="list-style-type: none"> <li>- ±75 000 000 000mW</li> </ul> </li> <li>■ <math>3 * U_{max} * I_{max} * WANDLER\_I</math> = e.g.: <math>3 * 100V * 1A * 5000</math></li> </ul> <p>If the Total power is exceeded by ±75 000 000 000mW, the max value is output.</p>
<b>Overflow energy meter</b>	<ul style="list-style-type: none"> <li>■ 0xXX112233             <ul style="list-style-type: none"> <li>- XX: not used</li> <li>- 11: Overflow phase L1</li> <li>- 22: Overflow phase L2</li> <li>- 33: Overflow phase L3</li> </ul> </li> </ul>

#### Measurands Data type FLOAT

ID	Description	Data type	Unit	Min. value	Max. value
1	Counter: Active energy consumer	FLOAT	1Wh <sup>1</sup>	0	5.497558 x 10 <sup>8</sup>
2	Counter: Active energy producer	FLOAT	1Wh <sup>1</sup>	0	5.497558 x 10 <sup>8</sup>
3	Counter: Active energy L1 consumer	FLOAT	1Wh <sup>1</sup>	0	5.497558 x 10 <sup>8</sup>
4	Counter: Active energy L1 producer	FLOAT	1Wh <sup>1</sup>	0	5.497558 x 10 <sup>8</sup>
5	Counter: Active energy L2 consumer	FLOAT	1Wh <sup>1</sup>	0	5.497558 x 10 <sup>8</sup>
6	Counter: Active energy L2 producer	FLOAT	1Wh <sup>1</sup>	0	5.497558 x 10 <sup>8</sup>
7	Counter: Active energy L3 consumer	FLOAT	1Wh <sup>1</sup>	0	5.497558 x 10 <sup>8</sup>
8	Counter: Active energy L3 producer	FLOAT	1Wh <sup>1</sup>	0	5.497558 x 10 <sup>8</sup>
9	Total active power	FLOAT	1W	-3.75 x 10 <sup>6</sup>	3.75 x 10 <sup>6</sup>
10	Total reactive power	FLOAT	1W	-3.75 x 10 <sup>6</sup>	3.75 x 10 <sup>6</sup>
11	Total apparent power	FLOAT	1W	-3.75 x 10 <sup>6</sup>	3.75 x 10 <sup>6</sup>
12	Frequency	FLOAT	10Hz	4.600 x 10 <sup>3</sup>	6.400 x 10 <sup>3</sup>
13	Total Cos φ <sup>2</sup>	FLOAT	10	-0.01	1.0
14	Temperature	FLOAT	10°C	-2.500 x 10 <sup>3</sup>	8.500 x 10 <sup>3</sup>
15	Active power L1	FLOAT	1W	-1.25 x 10 <sup>6</sup>	1.25 x 10 <sup>6</sup>
16	Reactive power L1	FLOAT	1W	-1.25 x 10 <sup>6</sup>	1.25 x 10 <sup>6</sup>
17	Total power L1	FLOAT	1W	-1.25 x 10 <sup>6</sup>	1.25 x 10 <sup>6</sup>
18	Voltage L1	FLOAT	1V	0	3.0 x 10 <sup>4</sup>
19	Current L1	FLOAT	1A	0	2.5 x 10 <sup>4</sup>
20	Cos φ L1 <sup>2</sup>	FLOAT	10	-0.01	1.0
21	Harmonic voltage L1	FLOAT	1V	0	3.0 x 10 <sup>4</sup>

ID	Description	Data type	Unit	Min. value	Max. value
22	Harmonic current L1	FLOAT	1A	0	$2.5 \times 10^4$
23	Active power L2	FLOAT	1W	$-1.25 \times 10^6$	$1.25 \times 10^6$
24	Reactive power L2	FLOAT	1W	$-1.25 \times 10^6$	$1.25 \times 10^6$
25	Total power L2	FLOAT	1W	$-1.25 \times 10^6$	$1.25 \times 10^6$
26	Voltage L2	FLOAT	1V	0	$3.0 \times 10^4$
27	Current L2	FLOAT	1A	0	$2.5 \times 10^4$
28	Cos $\varphi$ L2 <sup>2</sup>	FLOAT	10	-0.01	1.0
29	Harmonic voltage L2	FLOAT	1V	0	$3.0 \times 10^4$
30	Harmonic current L2	FLOAT	1A	0	$2.5 \times 10^4$
31	Active power L3	FLOAT	1W	$-1.25 \times 10^6$	$1.25 \times 10^6$
32	Reactive power L3	FLOAT	1W	$-1.25 \times 10^6$	$1.25 \times 10^6$
33	Total power L3	FLOAT	1W	$-1.25 \times 10^6$	$1.25 \times 10^6$
34	Voltage L3	FLOAT	1V	0	$3.0 \times 10^4$
35	Current L3	FLOAT	1A	0	$2.5 \times 10^4$
36	Cos $\varphi$ L3 <sup>2</sup>	FLOAT	10	-0.01	1.0
37	Harmonic voltage L3	FLOAT	1V	0	$3.0 \times 10^4$
38	Harmonic current L3	FLOAT	1A	0	$2.5 \times 10^4$
39	Overflow energy meter consumer Is incremented by 1 in case of overflow of the energy meter (ID = 1)	FLOAT		Overflow energy meter is at FLOAT not effective	
40	Overflow energy meter producer Is incremented by 1 in case of overflow of the energy meter (ID = 2)	FLOAT		Overflow energy meter is at FLOAT not effective	
41	Status bits <a href="#">↔ 'Status bits'...page 361</a>	UINT_32			

1) The display resolution of the energy meter is  $1\text{Wh} \times \text{WANDLER\_I}$  (current transformer factor). [↔ 'Parameter - 031-1PA00'...page 350](#)

2) The measuring accuracy of the Cos  $\varphi$  is maintained from a minimum current of  $100\text{mA} \times \text{WANDLER\_I}$  (current transformer factor).

### Tolerance

See Technical data [↔ '031-1PA00'...page 338](#)

### ID

Each measurand one *ID* is assigned. The access to the measured value of a measurand happens by means of the corresponding *ID*.

### Data type

[↔ 'Data type'...page 344](#)

### Max. Total power

- The max. Total power for 3 phases is
  - $\pm 3.75 \times 10^6 \text{mW}$  (FLOAT)
- $3 * U_{\text{max}} * I_{\text{max}} * \text{WANDLER\_I}$  = e.g.:  $3 * 100\text{V} * 1\text{A} * 30$

If the Total power is exceeded by  $\pm 3.75 \times 10^6 \text{mW}$  (FLOAT), the max value is output.

**Status bits**

With *status bits* you get information about limit violations.

- The limit values can be defined via the parametrization. → '[Parameter - 031-1PA00'...page 350](#)
- The *status bits* are refreshed together with the other measurement values, as soon as the DS-ID is incremented.
- Set bits of *status bits* remain set as long as they are acknowledged by → '[CMD Frame'...page 369](#).
  - By acknowledging the *status bits*, the corresponding LEDs for exceeding the limit value will be deleted again.
- Byte order: high byte, low byte (big endian)

Byte	Description
0	0: de-activated, 1: activated <ul style="list-style-type: none"> <li>■ Bit 0: Voltage at phase L2 below limit value (L2: VRMS_MIN)</li> <li>■ Bit 1: Voltage at phase L3 below limit value (L3: VRMS_MIN)</li> <li>■ Bit 2: Voltage at phase L1 above limit value (L1: VRMS_MAX)</li> <li>■ Bit 3: Voltage at phase L2 above limit value (L2: VRMS_MAX)</li> <li>■ Bit 4: Voltage at phase L3 above limit value (L3: VRMS_MAX)</li> <li>■ Bit 5: Temperature above limit value (T_MAX)</li> <li>■ Bit 6: Frequency below limit value (F_MIN)</li> <li>■ Bit 7: Frequency above limit value (F_MAX)</li> </ul>
1	0: de-activated, 1: activated <ul style="list-style-type: none"> <li>■ Bit 0               <ul style="list-style-type: none"> <li>– 0: deleted via CMD Frame (0x04)</li> <li>– 1: if there was a RESET of the module. This happens after PowerON.</li> </ul> </li> <li>■ Bit 1: Current at phase L1 above limit value (L1: IRMS_MAX)</li> <li>■ Bit 2: Current at phase L2 above limit value (L2: IRMS_MAX)</li> <li>■ Bit 3: Current at phase L3 above limit value (L3: IRMS_MAX)</li> <li>■ Bit 4: Efficiency <math>\cos \varphi</math> phase L1 below limit value (L1: PF_MIN)</li> <li>■ Bit 5: Efficiency <math>\cos \varphi</math> phase L2 below limit value (L2: PF_MIN)</li> <li>■ Bit 6: Efficiency <math>\cos \varphi</math> phase L3 below limit value (L3: PF_MIN)</li> <li>■ Bit 7: Voltage at phase L1 below limit value (L1: VRMS_MIN)</li> </ul>
2, 3	reserved

**3.28.7 Process data communication****Overview**

During runtime the communication with the module happens via telegrams in the process image. Here you have the following possibilities:

- Read measured value
- Define Frame with measurands
- Read Frame with measured values
- Send control command

**3.28.7.1 Structure****Telegram**

The communication takes place via the I/O area of the head module. The head module sends via the output area a request telegram to the module. This responds with the requested data within the input area of the head module. Depending on the used head module this may take several cycles to complete, until the data are received in the input area. To ensure the consistency of all measured values, which originate from the same measurement, are stored in the module under one *DS-ID*. → '[DS-ID'...page 343](#)

For input and output data the telegram has a length of 16byte and the following structure:

Byte	Function
B0	B0: Header byte 0 <ul style="list-style-type: none"> <li>■ Bit 3 ... 0: Status communication → <a href="#">‘Status communication’...page 363</a></li> <li>■ Bit 6 ... 4: Telegram type → <a href="#">‘Telegram type’...page 364</a></li> <li>■ Bit 7: 0 fix reserved</li> </ul>
B1	B1: Header byte 1 <ul style="list-style-type: none"> <li>■ ID of the measurand (1 ... 41)               <ul style="list-style-type: none"> <li>– Each measurand one <i>ID</i> is assigned. The access to the measured value of a measurand happens by means of the corresponding <i>ID</i></li> <li>→ <a href="#">‘Measurands - 031-1PA10’...page 353</a></li> <li>→ <a href="#">‘Measurands - 031-1PA00’...page 357</a></li> </ul> </li> </ul>
B2	B2: Header byte 2 <ul style="list-style-type: none"> <li>■ Bit 3 ... 0: Data set ID (<i>DS-ID</i>) of the measured value (1 ... 15)               <ul style="list-style-type: none"> <li>– The measured values of one measurement are accessible in the module via one <i>DS-ID</i>.</li> </ul> </li> <li>■ Bit 7 ... 4: Length of the user data (1 ... 12)               <ul style="list-style-type: none"> <li>– Depending on the telegram type, here up to 12 byte user data can be found.</li> </ul> </li> </ul>
B3	B3: Header byte 3 - <i>Common status</i> → <a href="#">‘Common status’...page 363</a>
D00	D00 ... D11: User data
...	<ul style="list-style-type: none"> <li>■ User data for data to be sent and received</li> </ul>
D11	Length of user data are specified from D00 ... D11: On error no user data are transferred i.e. the length of the user data is 0 and the module returns an error ID. Range of values: 0 ... 12

### 3.28.7.2 Status communication

Via the header byte (bit 3 ... 0) the status of the communication can be determined. On error no user data are transferred i.e. the length of the user data is 0. Please note that low error IDs are overridden by higher error IDs.

Status	Designation
0x00	OK (no error)
0x01	Error: Record set could not be refreshed
0x02	Error: <i>DS-ID</i>
0x03	Error: Telegram length
0x04	Error: <i>Frame</i> too big
0x05	Error: <i>Frame</i> not defined
0x06	Error: Measurand not available <ul style="list-style-type: none"> <li>■ <a href="#">↔ 'Measurands - 031-1PA10'...page 353</a></li> <li>■ <a href="#">↔ 'Measurands - 031-1PA00'...page 357</a></li> </ul>
0x07	Error: ' <i>CMD Frame</i> ' - Command could not be executed
0x08	Error: ' <i>Set Frame</i> ' - Frame definition is not valid (Set Frame)
0x09	Error: Telegram type not available - invalid request
0x0A	Error: Parameter - the last parameter set was not valid
0x0E	External error - Please contact our support
0x0F	Internal error: Due to a temporary disturbance during the processing of the measurement data, they could not be refreshed. If this error occurs more often, please contact our hotline.

### 3.28.7.3 Common status

With this byte you get an overview of possible error messages:

- Bit 0: Frequency  $F_{MAX}$  exceeded
- Bit 1: Frequency  $F_{MIN}$  undershot
- Bit 2: Temperature  $T_{MAX}$  exceeded
- Bit 3: Voltage  $VRMS_{MAX}$  exceeded
- Bit 4: Voltage  $VRMS_{MIN}$  undershot
- Bit 5: Efficiency  $PF_{MIN}$  undershot
- Bit 6: Current  $IRMS_{MAX}$  exceeded
- Bit 7: reserved

Detailed information about an error can be found in the *Status bits*:

- 031-1PA10 [↔ 'Status bits'...page 357](#)
- 031-1PA00 [↔ 'Status bits'...page 361](#)

### 3.28.7.4 Telegram type

By specifying the *Telegram type* the content of the responded data is defined. The following telegram types are available:

Type	Designation	Page
0x00	'Zero Frame': Accessing <i>Frame 0</i>	<a href="#">↗ 364</a>
0x10	'Read Value': Read the measured value of a measurand	<a href="#">↗ 364</a>
0x20	'Read Frame': Read a previously defined data package (Frame)	<a href="#">↗ 368</a>
0x30	'Set Frame': Define the data areas of a data package (Frame)	<a href="#">↗ 365</a>
0x40	'CMD Frame': Send a command	<a href="#">↗ 369</a>
0x60 <sup>1</sup>	'Read Param': Read Parameter	<a href="#">↗ 373</a>

1) This telegram type is not supported by the energy measurement module 031-1PA00.

#### 3.28.7.4.1 Zero Frame

This telegram type is the same as the telegram type '*Read Frame*' [↗ 'Read Frame'...page 368](#) applied at *Frame 0*. After the start-up of the module there are automatic *Zero Frame* requests as long as the process data communication comes from the head module.

#### 3.28.7.4.2 Read Value

With '*Read Value*' all the measured values can be requested.

##### Request

Byte	Value	Description
B0	0x10	<ul style="list-style-type: none"> <li>Bit 3 ... 0: Error code (not relevant)</li> <li>Bit 6 ... 4: 001 Telegram type '<i>Read Value</i>'</li> <li>Bit 7: 0 fix reserved</li> </ul>
B1	...	<ul style="list-style-type: none"> <li><i>ID</i> of the measurand. <a href="#">↗ 'ID'...page 343</a></li> </ul>
B2	...	<ul style="list-style-type: none"> <li>Bit 7 ... 4: Length user data (0)</li> <li>Bit 3 ... 0: Data set ID <i>DS-ID</i> of the measured value to be read. <a href="#">↗ 'DS-ID'...page 343</a></li> </ul>
B3	0x00	<ul style="list-style-type: none"> <li>Common status (not relevant).</li> </ul>
D00	-	<ul style="list-style-type: none"> <li>User data (not relevant).</li> </ul>
...		
D11		

##### Response

Byte	Value	Description
B0	0x10	<ul style="list-style-type: none"> <li>Bit 3 ... 0: Status communication <a href="#">↗ 'Status communication'...page 363</a></li> <li>Bit 6 ... 4: 001 Telegram type '<i>Read Value</i>'</li> <li>Bit 7: 0 fix reserved</li> </ul>
B1	...	<ul style="list-style-type: none"> <li><i>ID</i> of the measurand from the request.</li> </ul>
B2	...	<ul style="list-style-type: none"> <li>Bit 7 ... 4: Length of the user data with measured values in byte.</li> <li>Bit 3 ... 0: <i>DS-ID</i> of the measured value from the request, which was read.</li> </ul>
B3	...	<ul style="list-style-type: none"> <li>Common status <a href="#">↗ 'Common status'...page 363</a></li> </ul>



Byte	Value	Description
D00	...	<ul style="list-style-type: none"> <li>■ User data with the requested measured value</li> <li>■ depending on the parameterized data format               <ul style="list-style-type: none"> <li>- Byte order: high byte, low byte (big endian)</li> <li>- Byte order: low byte, high byte (little endian)</li> </ul> </li> </ul>
...		
D11		

**Example 'Read Value'**

In the example with  $ID = 14$  the temperature of the module for  $DS-ID = 1$  is requested.

**Request**

Byte	Value	Description
B0	0x10	Telegram type 'Read Value'.
B1	0x0E	$ID$ of the measurand. → ' <a href="#">ID'...page 343</a>
B2	0x01	$DS-ID$ of the measured value to be read ( $DS-ID = 1$ ). → ' <a href="#">DS-ID'...page 343</a>
B3	0x00	Common status (not relevant).
D00	-	User data (not relevant).
...		
D11		

**Response**

Byte	Value	Description
B0	0x10	Telegram type 'Read value' from the request.
B1	0x0E	$ID$ of the measurand from the request.
B2	0x21	Length of the user data here temperature 2 byte. $DS-ID$ of the measured value from the request, which was read.
B3	0x00	Common status: OK → ' <a href="#">Common status'...page 363</a>
D00	0x00	User data with the requested temperature e.g. 35°C.
D01	0x23	

**3.28.7.4.3 Set Frame****Overview**

In the module you can combine some measurands to one data package (Frame → '[Frame'...page 343](#)), which is transferred in one step. With 'Set Frame' a Frame can be built.

**Request**

Byte	Value	Description
B0	0x30	<ul style="list-style-type: none"> <li>■ Bit 3 ... 0: Error code (not relevant)</li> <li>■ Bit 6 ... 4: 011 Telegram type 'Set Frame'</li> <li>■ Bit 7: 0 fix reserved</li> </ul>
B1	...	■ $FR-ID$ of the Frame to be set. → ' <a href="#">FR-ID'...page 344</a>
B2	...	<ul style="list-style-type: none"> <li>■ Bit 7 ... 4: Length user data: 1 byte each measurand</li> <li>■ Bit 3 ... 0: <math>DS-ID</math></li> </ul>
B3	0x00	■ Common status (not relevant).

031-1PAxx - AI1x 3Ph 230/400V &gt; Process data communication

Byte	Value	Description
D00	...	<ul style="list-style-type: none"> <li>■ 1byte each measurand regarding that the measured values do not exceed the total length of 12byte. Here, the format of the measured values is taken into account (depending on the parameterized data type: INT or FLOAT).</li> <li>➔ <a href="#">‘Measurands’...page 353</a></li> <li>➔ <a href="#">‘Data type’...page 344</a></li> </ul>
...		
D11		

**Response**

Byte	Value	Description
B0	0x30	<ul style="list-style-type: none"> <li>■ Bit 3 ... 0: Status communication ➔ <a href="#">‘Status communication’...page 363</a></li> <li>■ Bit 6 ... 4: 011 Telegram type ‘Set Frame’</li> <li>■ Bit 7: 0 fix reserved</li> </ul>
B1	...	■ <i>FR-ID</i> of the Frame from the request.
B2	...	<ul style="list-style-type: none"> <li>■ Bit 7 ... 4: Length of the user data (0).</li> <li>■ Bit 3 ... 0: <i>DS-ID</i></li> </ul>
B3	...	■ Common status ➔ <a href="#">‘Common status’...page 363</a>
D00	...	■ User data (not relevant).
...		
...		
D11		

**Example 'Set Frame'**

Here a Frame with *FR-ID* 0x01 is defined. The Frame contains the following measurands:

- ID: 03: Counter: Active energy L1 (consumer)
- ID: 13: total cos  $\varphi$
- ID: 12: Frequency

**Request**

Byte	Value	Description
B0	0x30	Telegram type 'Set Frame'.
B1	0x01	<i>FR-ID</i> of the Frame to be read ( <i>FR-ID</i> = 1). → ' <i>FR-ID</i> '...page 344
B2	0x30	Bit 7 ... 4: Length user data (3). Bit 3 ... 0: data set ID <i>DS-ID</i> of the measurands (0).
B3	0x00	Common status (not relevant).
D00	0x03	User data with the ID of the measurands.
D01	0x0D	
D02	0x0C	
D03	-	
...		Remaining user data are not relevant.
D11		

**Response**

Byte	Value	Description
B0	0x30	Telegram type 'Set Frame' from the request.
B1	0x01	<i>FR-ID</i> of the Frame from the request.
B2	0x00	Bit 7 ... 4: Length of the user data (0). Bit 3 ... 0: data set ID <i>DS-ID</i> of the measurands (0).
B3	0x00	Common status: OK → ' <i>Common status</i> '...page 363
D00	-	User data (not relevant).
...	...	
D11	-	

## 3.28.7.4.4 Read Frame

## Overview

In the module you can combine some measurands to one data package (Frame → [‘Frame’...page 343](#)), which is transferred in one step.

With *‘Read Frame’* a Frame can be requested.

## Request

Byte	Value	Description
B0	0x20	<ul style="list-style-type: none"> <li>■ Bit 3 ... 0: Error code (not relevant)</li> <li>■ Bit 6 ... 4: 010 Telegram type <i>‘Read Frame’</i></li> <li>■ Bit 7: 0 fix reserved</li> </ul>
B1	...	<ul style="list-style-type: none"> <li>■ <i>FR-ID</i> of the Frame to be read. → <a href="#">‘FR-ID’...page 344</a></li> </ul>
B2	0x00	<ul style="list-style-type: none"> <li>■ Bit 7 ... 4: Length of the user data is 0.</li> </ul>
	...	<ul style="list-style-type: none"> <li>■ Bit 3 ... 0: <i>DS-ID</i> of the measured value to be read. → <a href="#">‘DS-ID’...page 343</a></li> </ul>
B3	0x00	<ul style="list-style-type: none"> <li>■ Common status (not relevant).</li> </ul>
D00	-	<ul style="list-style-type: none"> <li>■ User data (not relevant).</li> </ul>
...		
D11		

## Response

Byte	Value	Description
B0	0x20	<ul style="list-style-type: none"> <li>■ Bit 3 ... 0: Status communication → <a href="#">‘Status communication’...page 363</a></li> <li>■ Bit 6 ... 4: 010 Telegram type <i>‘Read Frame’</i></li> <li>■ Bit 7: 0 fix reserved</li> </ul>
B1	...	<ul style="list-style-type: none"> <li>■ <i>FR-ID</i> of the Frame from the request.</li> </ul>
B2	...	<ul style="list-style-type: none"> <li>■ Bit 7 ... 4: Length of the user data with measured values in byte</li> </ul>
	...	<ul style="list-style-type: none"> <li>■ Bit 3 ... 0: <i>DS-ID</i> of the measured value from the request, which was read.</li> </ul>
B3	...	<ul style="list-style-type: none"> <li>■ Common status → <a href="#">‘Common status’...page 363</a></li> </ul>
D00	...	<ul style="list-style-type: none"> <li>■ User data with the requested Frame with measured values. <ul style="list-style-type: none"> <li>- Depending on the parameterized data format.</li> </ul> </li> </ul>
...		
D11		

**Example 'Read Frame'**

In the example the previously via 'Set Frame' defined *FR-ID* (0x01) is requested with the following measurands:

- ID: 03: Counter: Active energy L1 (consumer): 4byte
- ID: 13: total cos  $\varphi$ : 1byte
- ID: 12: Frequency 2byte

**Request**

Byte	Value	Description
B0	0x20	Telegram type 'Read Frame'
B1	0x01	<i>FR-ID</i> of the Frame to be read ( <i>FR-ID</i> = 1). → ' <i>FR-ID</i> '...page 344
B2	0x01	Bit 7 ... 4: Length of the user data (0). Bit 3 ... 0: <i>DS-ID</i> of the measured value to be read ( <i>DS-ID</i> = 1). → ' <i>DS-ID</i> '...page 343
B3	0x00	Common status (not relevant).
D00	-	User data (not relevant).
...		
D11		

**Response**

Byte	Value	Description
B0	0x20	Telegram type 'Read value' from the request.
B1	0x01	<i>FR-ID</i> of the Frame from the request
B2	0x71	Bit 7 ... 4: Length of the Frame with measured values (7) Bit 3 ... 0: <i>DS-ID</i> of the measured value from the request (1).
B3	0x00	Common status: OK → ' <i>Common status</i> '...page 363
D00	0x00	Counter: Active energy L1 (consumer): 500kWh
D01	0x07	
D02	0xA1	
D03	0x20	
D04	0x5A	Total cos $\varphi$ : 0.9
D05	0x13	Frequency: 50Hz
D06	0x88	
D07	-	Remaining user data are not relevant.
...		
D11		

**3.28.7.4.5 CMD Frame**

With '*CMD Frame*' you can send control commands to the module. This can trigger various actions or be used for reading and writing of control registers. The following control commands are available:

- Reset the energy counter
- Reset the status bits
- Request the firmware version

031-1PAxx - AI1x 3Ph 230/400V &gt; Process data communication

- Read holding register (not 031-1PA00)
- Write counter values respectively set the active energy meters L1 - L3 (not 031-1PA00)



Please note that energy values must always be written in **INTEGER** format, even if you have set the module to **FLOAT** mode.

## Request

Byte	Value	Description
B0	0x40	<ul style="list-style-type: none"> <li>■ Bit 3 ... 0: Error code (not relevant)</li> <li>■ Bit 6 ... 4: 100 Telegram type 'CMD Frame'</li> <li>■ Bit 7: reserved</li> </ul>
B1	...	<ul style="list-style-type: none"> <li>■ <b>CMD-ID</b> of the control command, which is to be executed: <ul style="list-style-type: none"> <li>– 0x01: Reset of all energy counters</li> <li>– 0x03: Reset the status bits</li> <li>– 0x04: Request the firmware version</li> <li>– 0x06<sup>1</sup>: Read holding register</li> <li>– 0x07<sup>1</sup>: Write in active energy meter</li> </ul> </li> </ul>
B2	...	<ul style="list-style-type: none"> <li>■ Bit 7 ... 4: Length of the user data depending on <b>CMD-ID</b>: <ul style="list-style-type: none"> <li>– 0x01: Reset of all energy counters (length user data: 0byte)</li> <li>– 0x03: Reset the status bits (length user data: 4byte)</li> <li>– 0x04: Request the firmware version (length user data: 0byte)</li> <li>– 0x06<sup>1</sup>: Read holding register (length user data: 0byte)</li> <li>– 0x07<sup>1</sup>: Write in active energy meter (length user data: 6byte)</li> </ul> </li> </ul>
	...	<ul style="list-style-type: none"> <li>■ Bit 3 ... 0: Data set ID <b>DS-ID</b> of the measured value (3 ... 7).</li> </ul>
B3	0x00	<ul style="list-style-type: none"> <li>■ Common status (not relevant).</li> </ul>
D00	-	<ul style="list-style-type: none"> <li>■ User data depending on <b>CMD-ID</b> <ul style="list-style-type: none"> <li>– 0x01: Reset of all energy counters (user data: not relevant)</li> <li>– 0x03: Reset the status bits (user data: 4byte with the corresponding set bits)</li> <li>– 0x04: Request the firmware version (user data: not relevant)</li> <li>– 0x06<sup>1</sup>: Read holding register (user data: not relevant)</li> <li>– 0x07<sup>1</sup>: Write in active energy meter</li> </ul> </li> </ul>
...		
D11		

1) This is not supported by the energy measurement module 031-1PA00.

## Response

Byte	Value	Description
B0	0x40	<ul style="list-style-type: none"> <li>■ Bit 3 ... 0: Status communication → '<a href="#">Status communication</a>'...page 363</li> <li>■ Bit 6 ... 4: 100 Telegram type 'CMD Frame'</li> <li>■ Bit 7: 0 fix reserved</li> </ul>
B1	...	<ul style="list-style-type: none"> <li>■ <b>CMD-ID</b> from the request.</li> </ul>

Byte	Value	Description
B2	...	<ul style="list-style-type: none"> <li>■ Bit 7 ... 4: Length of the user data depending on <i>CMD-ID</i>: <ul style="list-style-type: none"> <li>- 0x01: Reset of all energy counters (length user data: 0byte)</li> <li>- 0x03: Reset the status bits: (length user data: 4byte)</li> <li>- 0x04: Request the firmware version (Length user data: 10byte)</li> <li>- 0x06<sup>1</sup>: Read holding register</li> <li>- 0x07<sup>1</sup>: Write in active energy meter</li> </ul> </li> <li>■ Bit 3 ... 0: <i>DS-ID</i> (not relevant)</li> </ul>
B3	...	<ul style="list-style-type: none"> <li>■ Common status → '<a href="#">Common status</a>'...page 363</li> </ul>
D00	...	<ul style="list-style-type: none"> <li>■ User data depending on <i>CMD-ID</i>: <ul style="list-style-type: none"> <li>- 0x01: Reset of all energy counters (user data: nothing)</li> <li>- 0x03: Reset the status bits: (User data: 4byte with the corresponding set bits)</li> <li>- 0x04: Request the firmware version (user data: 10byte with the version information)</li> <li>- 0x06<sup>1</sup>: Read holding register</li> <li>- 0x07<sup>1</sup>: Write in active energy meter</li> </ul> </li> <li>■ Byte order: high byte, low byte (big endian) Byte order: low byte, high byte (little endian)</li> </ul>
...		
D11		

1) This is not supported by the energy measurement module 031-1PA00.

### Firmware version

- Byte 2... 0: Firmware version
- Byte 5 ... 3: Protocol version
  - Byte 3: Major
  - Byte 4: Minor
  - Byte 5: Revision
- Byte 9 ... 6: Measuring chip version
  - Byte 6: Day
  - Byte 7: Month
  - Byte 8: Year (hundreds)
  - Byte 9: Year (one)

### Write in active energy meter (not 031-1PA00)

- Setting active energy meters L1 - L3 (consumers, producers)
- Byte 0: ID of the measured value to be written (*ID*: 3 ... 8).
  - Byte 1: Overflow counter
  - Byte 5 ... 2: New measured value

031-1PAxx - AI1x 3Ph 230/400V &gt; Process data communication

**Example 'CMD Frame'**      In this example all the status bits are reset.

**Request**

Byte	Value	Description
B0	0x40	Telegram type ' <i>CMD Frame</i> '
B1	0x03	<i>CMD-ID</i> : Reset the status bits
B2	0x40	Reset the status bits: (length user data: 4byte)
B3	0x00	Common status (not relevant).
D00	0xFF	User data: Reset the status bits
D01	0xFF	
D02	0xFF	
D03	0xFF	

**Response**

Byte	Value	Description
B0	0x40	Telegram type ' <i>CMD Frame</i> ' from the request.
B1	0x03	<i>CMD-ID</i> from the request.
B2	0x40	Length of the user data from the request.
B3	0x00	Common status: OK → ' <i>Common status</i> '... <a href="#">page 363</a>
D00	0xFF	User data from the request.
D01	0xFF	
D02	0xFF	
D03	0xFF	



## 3.28.7.4.6 Read Param



*This telegram type is not supported by the energy measurement module 031-1PA00.*

With 'Read Param' (0x60) the parameters can be read via the process image.

## Request

Byte	Value	Description
B0	0x60	<ul style="list-style-type: none"> <li>Bit 3 ... 0: Error code (not relevant)</li> <li>Bit 6 ... 4: 110 Telegram type 'Read Param'</li> <li>Bit 7: reserved</li> </ul>
B1	...	<ul style="list-style-type: none"> <li>IDx of the parameter to be read. → <a href="#">'Parameter data'...page 347</a></li> </ul>
B2	...	<ul style="list-style-type: none"> <li>Bit 7 ... 4: Length user data (0)</li> <li>Bit 3 ... 0: Data set ID <i>DS-ID</i> (relevant for one time reading).</li> </ul>
B3		<ul style="list-style-type: none"> <li>Common status (not relevant).</li> </ul>
D00	...	<ul style="list-style-type: none"> <li>User data (not relevant).</li> </ul>
...		
D11		

## Response

Byte	Value	Description
B0	0x60	<ul style="list-style-type: none"> <li>Bit 3 ... 0: Status communication → <a href="#">'Status communication'...page 363</a></li> <li>Bit 6 ... 4: 110 Telegram type 'Read Param'</li> <li>Bit 7: reserved</li> </ul>
B1	...	<ul style="list-style-type: none"> <li>IDx of the read parameter.</li> </ul>
B2	...	<ul style="list-style-type: none"> <li>Bit 7 ... 4: Length of the user data (0)</li> <li>Bit 3 ... 0: Data set ID <i>DS-ID</i></li> </ul>
B3	...	<ul style="list-style-type: none"> <li>Common status → <a href="#">'Common status'...page 363</a></li> </ul>
D00	...	<ul style="list-style-type: none"> <li>Parameter value that was read.</li> </ul>
...		
D11		

### 3.28.7.5 Example

#### Communication

Here the communication and the query of the status bits ( $ID = 41$ ) are described on an example.

No.	Request	Response	Description
1	0x10 0x01 0x03 0x00		An $ID$ and $DS-ID$ is requested: e.g.: M 1-3 M ( $ID$ )-( $DS-ID$ )
3		0x10 0x01 0x43 0x01 (4 byte data)	M 1-3 indicates frequency exceeded.
4	0x10 0x29 0x03 0x00		Query the status bits M 41-3.
5		0x10 0x29 0x43 0x05 0x00 0x00 0x80 0x00	Frequency exceeded and temperature exceeded is reported.
6	0x10 0x29 0x04 0x00		Query the status bits M 41-4.
7		0x10 0x29 0x44 0x05 0x00 0x00 0xA0 0x00	The status bit were refreshed ( $ID = 41$ ) and temperature exceeded is reported.
8	0x40 0x03 0x45 0x00 0x00 0x00 0xA0 0x00		Reset the status bits (frequency exceeded and temperature exceeded).
9		0x40 0x03 0x45 0x00 0x00 0x00 0xA0 0x00	Status bits have been reset.
10	0x10 0x29 0x05 0x00		Query the status bits M 41-5.
11		0x10 0x29 0x45 0x00 0x00 0x00 0x20 0x00	Status bits have been reset. Temperature exceeded is reported.

## 3.28.8 Error messages and diagnostics

### 3.28.8.1 Status and error messages

**Common status** → [‘Common status’...page 363](#)

**Status communication** → [‘Status communication’...page 363](#)

**Status bits**

- 053-1PA10 → [‘Status bits’...page 357](#)
- 053-1PA00 → [‘Status bits’...page 361](#)

### 3.28.8.2 Diagnostic data

This module does not support diagnostic interrupt functions, the diagnostics data serve for information about this module. On error the corresponding channel LED of the module is activated and the error is registered in the diagnostics data.

The following errors are listed in the diagnostics data:

- Error in configuration / parametrization

- DS Record set for access via CPU, PROFIBUS and PROFINET. The access happens by DS 01h. Additionally the first 4 bytes may be accessed by DS 00h.
- IX Index for access via CANopen. The access happens by IX 2F01h. Additionally the first 4 bytes may be accessed by IX 2F00h.
- SX Subindex for access via EtherCAT with Index 5005h.
- More can be found in the according manual of your bus coupler.

Name	Bytes	Function	Default	DS	IX	SX
ERR_A	1	Diagnostic	00h	01h	2F01h	02h
MODTYP	1	Module information	15h			03h
ERR_C	1	reserved	00h			04h
ERR_D	1	Diagnostic	00h			05h
CHTYP	1	Channel type	71h			06h
NUMBIT	1	Number diagnostic bits per channel	08h			07h
NUMCH	1	Number of channels of a module	03h			08h
CHERR	1	Channel error	00h			09h
CH0ERR	1	Channel-specific error channel 0	00h			0Ah
CH1ERR	1	Channel-specific error channel 1	00h			0Bh
CH2ERR	1	Channel-specific error channel 2	00h			0Ch
CH3ERR... CH7ERR	5	reserved	00h			0Dh ... 11h
DIAG_US	4	µs ticker	00h			13h

**ERR\_A Diagnostic**

Byte	Bit 7 ... 0
0	<ul style="list-style-type: none"> <li>■ Bit 0: set at module failure</li> <li>■ Bit 1: set at internal error</li> <li>■ Bit 2: set at external error</li> <li>■ Bit 3: set at channel error</li> <li>■ Bit 4: set at external auxiliary supply missing</li> <li>■ Bit 6 ... 5: reserved</li> <li>■ Bit 7: set at error in parametrization</li> </ul>

**MODTYP  
Module information**

Byte	Bit 7 ... 0
0	<ul style="list-style-type: none"> <li>■ Bit 3 ... 0: module class <ul style="list-style-type: none"> <li>– 0101b analog module</li> </ul> </li> <li>■ Bit 4: set at channel information present</li> <li>■ Bit 7 ... 5: reserved</li> </ul>

**ERR\_D Diagnostic**

Byte	Bit 7 ... 0
0	<ul style="list-style-type: none"> <li>■ Bit 2 ... 0: reserved</li> <li>■ Bit 3: set at internal diagnostics buffer overflow</li> <li>■ Bit 4: set at internal communication error</li> <li>■ Bit 7 ... 5: reserved</li> </ul>

**CHTYP Channel type**

Byte	Bit 7 ... 0
0	<ul style="list-style-type: none"> <li>■ Bit 6 ... 0: Channel type <ul style="list-style-type: none"> <li>- 70h: Digital input</li> <li>- 71h: Analog input</li> <li>- 72h: Digital output</li> <li>- 73h: Analog output</li> <li>- 74h: Analog input/-output</li> <li>- 76h: Counter</li> </ul> </li> <li>■ Bit 7: reserved</li> </ul>

**NUMBIT Diagnostic bits**

Byte	Bit 7 ... 0
0	Number of diagnostic bits per channel (here 08h)

**NUMCH Channels**

Byte	Bit 7 ... 0
0	Number of channels of the module (here 03h)

**CHERR Channel error**

Byte	Bit 7 ... 0
0	<ul style="list-style-type: none"> <li>■ Bit 0: set at error in channel 0</li> <li>■ Bit 1: set at error in channel 1</li> <li>■ Bit 2: set at error in channel 2</li> <li>■ Bit 7 ... 3: reserved</li> </ul>

**CHxERR Channel-specific**

Byte	Bit 7 ... 0
0	Channel-specific error channel x <ul style="list-style-type: none"> <li>■ Bit 0: set at configuration / parametrization error</li> <li>■ Bit 7 ... 1: reserved</li> </ul>

**CH3ERR ... CH7ERR reserved**

Byte	Bit 7 ... 0
0	reserved

**DIAG\_US  $\mu$ s ticker**

Byte	Bit 7 ... 0
0...3	Value of the $\mu$ s ticker at the moment of the diagnostic

 **$\mu$ s ticker**

In the System SLIO module there is a timer ( $\mu$ s ticker). With PowerON the timer starts counting with 0. After  $2^{32}-1\mu$ s the timer starts with 0 again.

**3.28.9 Product specific handling blocks**

The product specific blocks can be found as library download file in the 'Download Center' of [www.yaskawa.eu.com](http://www.yaskawa.eu.com) under 'Controls Library' 'Device Specific - SW90LS0MA'. The library is available as packed zip file. As soon as you want to use product specific blocks you have to import them into your project. More information can be found in the manual for your block library. The following blocks are used for communication:

Blocks	Symbol	Description
UDT 325	EM_DATA_R1	Data structure for FB 325
FB 325	EM_COM_R1	Communication with 031-1PAxx for energy metering



More information about the usage of these blocks can be found in the manual "Device Specific - SW90LS0MA" at [www.yaskawa.eu.com](http://www.yaskawa.eu.com) in the 'Download Center' under 'Controls Library'.

**Functionality**

- The energy measuring module is used to measure the energy of a 3-phase connection. In addition to voltage, current and phase, the module determines many other measurands. → '[Measurands'](#)...page 353
- Limit values can be parametrized for some measurands. When exceeding or falling below corresponding interrupt status bits are set. The module supports several commands (CMD). For example, interrupt status bits can be reset hereby.
- With the function block FB 325 and the associated data structure of type UDT 325, you can read energy measured values and interrupt status bits of the energy measurement module and commands can be executed on the module. In this case, the FB 325 communicates via the cyclic I/O data (16 bytes each) of the module, which must be specified accordingly when FB 325 is called.
- The real request interface is realized via the data structure of the type UDT 325. As a result, a simple control and evaluation, for example via a touch panel is possible.

Analog value

## 4 Analog output

### 4.1 General

#### Cabling for analog signals

You must only use screened cable when you are connecting analog signals. These cables reduce the effect of electrical interference. The screen of the analog signal cable should be grounded at both ends. In situations with different electrical potentials, it is possible that a current will flow to equalize the potential difference. This current could interfere with the analog signals. Under these circumstances it is advisable to ground the screen of the signal cable at one end only.

#### Connecting loads and actuators

You can use the analog output modules to supply loads and actuators with current or voltage.



*Please take always care of the correct polarity when connecting actuators! Please leave the output clamps of not used channels disconnected and set the output type of the channel to "deactivated" in the hardware configurator from Siemens.*

#### Parameterization

The parameterization via CPU, PROFIBUS and PROFINET happens by means of record sets (DS). The corresponding record set number may be found at the respective module description. Here also the indices (IX) respectively subindices (SX) for CANopen respectively EtherCAT are listed.

#### Diagnostic functions

The modules have diagnostics capability. The following errors may release a diagnostic:

- Error in parameterization
- Short-circuit recognition
- Wire-break recognition



#### **Alternated blinking of the channel error LEDs**

*The alternate blinking of the channel error LEDs of channel 0 and 1 indicates a watchdog error due to a system overload. Restart with a power cycle your system. If the error occurred again, check configuration and circuit and adjust them if necessary. If the error persists, please contact our support.*

### 4.2 Analog value

#### Analog value representation

The analog values are only processed in binary representation. Hereby the binary word variable is transformed into an analog process signal and put out via the corresponding channel. The analog values are displayed as a fixed-point number in the two's complement.

Resolution	Analog value																
	High byte (byte 0)								Low byte (byte 1)								
Bit number	15	14	13	12	11	10	9	8	7	6	5	4	3	2	1	0	
Resolution	SG	2 <sup>14</sup>	2 <sup>13</sup>	2 <sup>12</sup>	2 <sup>11</sup>	2 <sup>10</sup>	2 <sup>9</sup>	2 <sup>8</sup>	2 <sup>7</sup>	2 <sup>6</sup>	2 <sup>5</sup>	2 <sup>4</sup>	2 <sup>3</sup>	2 <sup>2</sup>	2 <sup>1</sup>	2 <sup>0</sup>	
12Bit	SG	Analog value (word)												X	X	X	
15Bit	SG	Analog value (word)															

**Resolution** With a resolution of 12bit plus sign bit, the least significant bits (3bit) are not relevant.

**Sign bit (SG)** The algebraic sign bit is represented by Bit 15. Here it is essential:

- Bit 15 = "0": → positive value
- Bit 15 = "1": → negative value

### 4.3 Output ranges and function numbers

**General** In the following there are the output ranges listed with function number, which were supported by the corresponding analog module. The here listed formulas allow you to transform a value (digital value) to an analog value and vice versa.

#### 4.3.1 Voltage

Output range voltage 0 ... 10V (funct. no.)	Voltage (U)	Decimal (D)	Hex	Range	Formulas
0 ... 10V Siemens S7 format (10h)	11.76V	32511	7EFFh	overrange	$U = D \times \frac{10}{27648}$ $D = 27648 \times \frac{U}{10}$
	10V	27648	6C00h	nominal range	
	5V	13824	3600h		
	0V	0	0000h		
	Not possible, is limited to 0V.				
0 ... 10V Siemens S5 format (20h)	12.5V	20480	5000h	overrange	$U = D \times \frac{10}{16384}$ $D = 16384 \times \frac{U}{10}$
	10V	16384	4000h	nominal range	
	5V	8192	2000h		
	0V	0	0000h		
	Not possible, is limited to 0V.				

Output ranges and function numbers &gt; Current

Output range voltage ±10V (funct. no.)	Voltage (U)	Decimal (D)	Hex	Range	Formulas
±10V Siemens S7 format (12h)	11.76V	32511	7EFFh	overrange	$U = D \times \frac{10}{27648}$ $D = 27648 \times \frac{U}{10}$
	10V	27648	6C00h	nominal range	
	5V	13824	3600h		
	0V	0	0000h		
	-5V	-13824	CA00h		
	-10V	-27648	9400h		
	-11.76V	-32512	8100h	underrange	
±10V Siemens S5 format (22h)	12.5V	20480	5000h	overrange	$U = D \times \frac{10}{16384}$ $D = 16384 \times \frac{U}{10}$
	10V	16384	4000h	nominal range	
	5V	8192	2000h		
	0V	0	0000h		
	-5V	-8192	E000h		
	-10V	-16384	C000h		
	-12.5V	-20480	B000h	underrange	

### 4.3.2 Current

Output range current 0 ... 20mA (funct. no.)	Current (I)	Decimal (D)	Hex	Range	Formulas
0 ... 20mA Siemens S7 format (31h)	23.52mA	32511	7EFFh	overrange	$I = D \times \frac{20}{27648}$ $D = 27648 \times \frac{I}{20}$
	20mA	27648	6C00h	nominal range	
	10mA	13824	3600h		
	0mA	0	0000h		
	Not possible, is limited to 0mA.			underrange	
0 ... 20mA Siemens S5 format (41h)	25.00mA	20480	5000h	overrange	$I = D \times \frac{20}{16384}$ $D = 16384 \times \frac{I}{20}$
	20mA	16384	4000h	nominal range	
	10mA	8192	2000h		
	0mA	0	0000h		
	Not possible, is limited to 0mA.			underrange	



Output range current 4 ... 20mA (funct. no.)	Current (I)	Decimal (D)	Hex	Range	Formulas
4 ... 20mA Siemens S7 format (30h)	22.81mA	32511	7EFFh	overrange	$I = D \times \frac{16}{27648} + 4$ $D = 27648 \times \frac{I-4}{16}$
	20mA	27648	6C00h	nominal range	
	12mA	13824	3600h		
	4mA	0	0000h		
	0mA	-6912	E500h	underrange	
4 ... 20mA Siemens S5 format (40h)	24.00mA	20480	5000h	overrange	$I = D \times \frac{16}{16384} + 4$ $D = 16384 \times \frac{I-4}{16}$
	20mA	16384	4000h	nominal range	
	12mA	8192	2000h		
	4mA	0	0000h		
	0mA	-4096	F000h	underrange	

### 4.4 032-1BB30 - AO 2x12Bit 0...10V

#### Properties

The electronic module has 2 outputs with parameterizable functions. The channels of the module are electrically isolated from the backplane bus. In addition, the channels are isolated to the DC 24V power supply by means of DC/DC converter.

- 2 analog outputs
- Suited for sensors with 0 ... 10V
- Diagnostics function
- 12bit resolution

#### Structure

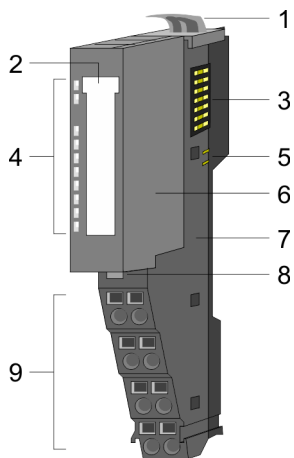

- 1 Locking lever terminal module
- 2 Labeling strip
- 3 Backplane bus
- 4 LED status indication
- 5 DC 24V power section supply
- 6 Electronic module
- 7 Terminal module
- 8 Locking lever electronic module
- 9 Terminal

#### Status indication

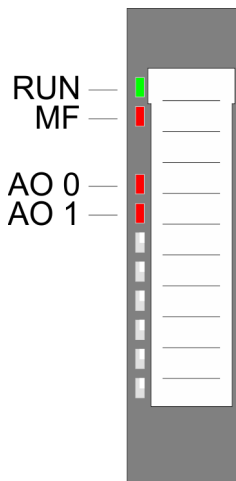

RUN	MF	AO x	Description
<input checked="" type="checkbox"/> green	<input checked="" type="checkbox"/> red	<input checked="" type="checkbox"/> red	
<input checked="" type="checkbox"/>	<input type="checkbox"/>	X	Bus communication is OK Module status is OK
<input checked="" type="checkbox"/>	<input checked="" type="checkbox"/>	X	Bus communication is OK Module status reports an error
<input type="checkbox"/>	<input checked="" type="checkbox"/>	X	Bus communication is not possible Module status reports an error
<input type="checkbox"/>	<input type="checkbox"/>	X	Error at bus power supply
X	<input checked="" type="checkbox"/>	X	Error in configuration → <a href="#">‘Trouble shooting - LEDs’...page 41</a>
<input checked="" type="checkbox"/>	<input type="checkbox"/>	<input checked="" type="checkbox"/>	Error channel x <ul style="list-style-type: none"> <li>■ Overload, short-circuit</li> <li>■ Error in parameterization</li> </ul>
not relevant: X			

**Pin assignment**

For wires with a cross section of 0.08mm<sup>2</sup> up to 1.5mm<sup>2</sup>.

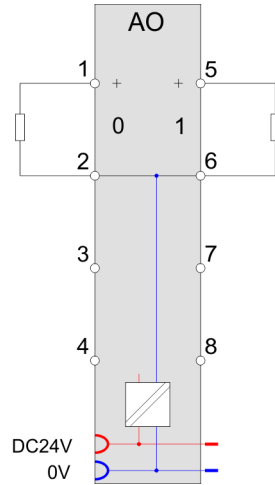
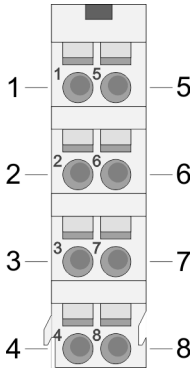

Pos.	Function	Type	Description
1	AO 0	O	Channel 0
2	AGND	O	Ground channels
3	---	---	not connected
4	---	---	not connected
5	AO 1	O	Channel 1
6	AGND	O	Ground channels
7	---	---	not connected
8	---	---	not connected

O: Output

**Input area**

No byte of the input area is used by the module.

**Output area**

At CPU, PROFIBUS and PROFINET the output area is embedded to the corresponding address area.

IX Index for access via CANopen with s = Subindex, depends on number and type of analog modules

SX Subindex for access via EtherCAT with Index 7000h + EtherCAT-Slot

More can be found in the according manual of your bus coupler.

Addr.	Name	Bytes	Function	IX	SX
+0	AO 0	2	Analog value channel 0	6411h/s	01h
+2	AO 1	2	Analog value channel 1	6411h/s+1	02h

## 4.4.1 Technical data

Order no.	032-1BB30
Type	SM 032 - Analog output
Module ID	0501 25D8
<b>Current consumption/power loss</b>	
Current consumption from backplane bus	85 mA
Current consumption from load voltage L+ (without load)	35 mA
Power loss	1.2 W
<b>Technical data analog outputs</b>	
Number of outputs	2
Cable length, shielded	200 m
Rated load voltage	DC 24 V
Reverse polarity protection of rated load voltage	✓
Current consumption from rated load voltage	-
Voltage output short-circuit protection	✓
Voltage outputs	✓
Min. load resistance (voltage range)	5 kΩ
Max. capacitive load (current range)	1 μF
Max. inductive load (current range)	10 mA
Output voltage ranges	0 V ... +10 V
Operational limit of voltage ranges	+/-0.3%
Basic error limit voltage ranges	+/-0.2%
Destruction limit against external applied voltage	max. 24V
Current outputs	-
Max. in load resistance (current range)	-
Max. inductive load (current range)	-
Typ. open circuit voltage current output	-
Output current ranges	-
Operational limit of current ranges	-
Basic error limit current ranges	-
Destruction limit against external applied voltage	-
Settling time for ohmic load	1.5 ms
Settling time for capacitive load	2 ms
Settling time for inductive load	-
Resolution in bit	12
Conversion time	2 ms all channels
Substitute value can be applied	no
Output data size	4 Byte
<b>Status information, alarms, diagnostics</b>	

Order no.	032-1BB30
Status display	yes
Interrupts	no
Process alarm	no
Diagnostic interrupt	no
Diagnostic functions	yes
Diagnostics information read-out	possible
Supply voltage display	green LED
Group error display	red LED
Channel error display	red LED per channel
<b>Isolation</b>	
Between channels	-
Between channels of groups to	-
Between channels and backplane bus	✓
Between channels and power supply	✓
Max. potential difference between circuits	-
Max. potential difference between inputs (U <sub>cm</sub> )	-
Max. potential difference between Mana and Mintern (U <sub>iso</sub> )	DC 75 V/ AC 50 V
Max. potential difference between inputs and Mana (U <sub>cm</sub> )	-
Max. potential difference between inputs and Mintern (U <sub>iso</sub> )	-
Max. potential difference between Mintern and outputs	-
Insulation tested with	DC 500 V
<b>Datasizes</b>	
Input bytes	0
Output bytes	4
Parameter bytes	8
Diagnostic bytes	20
<b>Housing</b>	
Material	PPE / PPE GF10
Mounting	Profile rail 35 mm
<b>Mechanical data</b>	
Dimensions (WxHxD)	12.9 mm x 109 mm x 76.5 mm
Net weight	60 g
Weight including accessories	60 g
Gross weight	74 g
<b>Environmental conditions</b>	
Operating temperature	0 °C to 60 °C

032-1BB30 - AO 2x12Bit 0...10V &gt; Parameter data

<b>Order no.</b>	<b>032-1BB30</b>
Storage temperature	-25 °C to 70 °C
<b>Certifications</b>	
UL certification	yes
KC certification	yes
UKCA certification	yes
ChinaRoHS certification	yes

#### 4.4.2 Parameter data

- DS Record set for access via CPU, PROFIBUS and PROFINET  
 IX Index for access via CANopen  
 SX Subindex for access via EtherCAT with Index 3100h + EtherCAT-Slot  
 More can be found in the according manual of your bus coupler.

Name	Bytes	Function	Default	DS	IX	SX
RES0	1	reserved	00h	00h	3100h	01h
SHORT_EN	1	Short-circuit recognition	00h	00h	3101h	02h
CH0FN	1	Function number channel 0	10h	80h	3102h	03h
CH1FN	1	Function number channel 1	10h	81h	3103h	04h

#### SHORT\_EN Short-circuit recognition

Byte	Bit 7 ... 0
0	<ul style="list-style-type: none"> <li>■ Bit 0: Short-circuit recognition channel 0 (1: on)</li> <li>■ Bit 1: Short-circuit recognition channel 1 (1: on)</li> <li>■ Bit 7 ... 2: reserved</li> </ul>

#### CHxFN Function number channel x

In the following there are the measuring ranges with corresponding function number listed, which were supported by the analog module. With FFh the corresponding channel is deactivated.

The formulas listed here allow you to transform an evaluated measuring value (digital value) to a value assigned to the measuring range (analog value) and vice versa.

Output range voltage 0 ... 10V (funct. no.)	Voltage (U)	Decimal (D)	Hex	Range	Formulas
0 ... 10V Siemens S7 format (10h)	11.76V	32511	7EFFh	overrange	$U = D \times \frac{10}{27648}$ $D = 27648 \times \frac{U}{10}$
	10V	27648	6C00h	nominal range	
	5V	13824	3600h		
	0V	0	0000h		
	Not possible, is limited to 0V.				
0 ... 10V Siemens S5 format (20h)	12.5V	20480	5000h	overrange	$U = D \times \frac{10}{16384}$ $D = 16384 \times \frac{U}{10}$
	10V	16384	4000h	nominal range	
	5V	8192	2000h		
	0V	0	0000h		
	Not possible, is limited to 0V.				

#### 4.4.3 Diagnostic data

So this module does not support diagnostic interrupt functions, the diagnostics data serve for information about this module. On error the corresponding channel LED of the module is activated and the error is registered in the diagnostics data.

The following errors are listed in the diagnostics data:

- Error in project engineering / parameterization
- Short-circuit/overload (if parameterized)

DS Record set for access via CPU, PROFIBUS and PROFINET. The access happens by DS 01h. Additionally the first 4 bytes may be accessed by DS 00h.

IX Index for access via CANopen. The access happens by IX 2F01h. Additionally the first 4 bytes may be accessed by IX 2F00h.

SX Subindex for access via EtherCAT with Index 5005h.

More can be found in the according manual of your bus coupler.

032-1BB30 - AO 2x12Bit 0...10V &gt; Diagnostic data

Name	Bytes	Function	Default	DS	IX	SX
ERR_A	1	Diagnostic	00h	01h	2F01h	02h
MODTYP	1	Module information	15h			03h
ERR_C	1	reserved	00h			04h
ERR_D	1	Diagnostic	00h			05h
CHTYP	1	Channel type	73h			06h
NUMBIT	1	Number diagnostic bits per channel	08h			07h
NUMCH	1	Number of channels of a module	02h			08h
CHERR	1	Channel error	00h			09h
CH0ERR	1	Channel-specific error channel 0	00h			0Ah
CH1ERR	1	Channel-specific error channel 1	00h			0Bh
CH2ERR... CH7ERR	6	reserved	00h			0Ch ... 11h
DIAG_US	4	µs ticker	00h			13h

**ERR\_A Diagnostic**

Byte	Bit 7 ... 0
0	<ul style="list-style-type: none"> <li>■ Bit 0: set at module failure</li> <li>■ Bit 1: set at internal error</li> <li>■ Bit 2: set at external error</li> <li>■ Bit 3: set at channel error</li> <li>■ Bit 4: set at external auxiliary supply missing</li> <li>■ Bit 6 ... 5: reserved</li> <li>■ Bit 7: set at error in parametrization</li> </ul>

**MODTYP**  
*Module information*

Byte	Bit 7 ... 0
0	<ul style="list-style-type: none"> <li>■ Bit 3 ... 0: module class <ul style="list-style-type: none"> <li>- 0101b analog module</li> </ul> </li> <li>■ Bit 4: set at channel information present</li> <li>■ Bit 7 ... 5: reserved</li> </ul>

**ERR\_D Diagnostic**

Byte	Bit 7 ... 0
0	<ul style="list-style-type: none"> <li>■ Bit 2 ... 0: reserved</li> <li>■ Bit 3: set at internal diagnostics buffer overflow</li> <li>■ Bit 4: set at internal communication error</li> <li>■ Bit 7 ... 5: reserved</li> </ul>



**CHTYP Channel type**

Byte	Bit 7 ... 0
0	<ul style="list-style-type: none"> <li>■ Bit 6 ... 0: Channel type               <ul style="list-style-type: none"> <li>- 70h: Digital input</li> <li>- 71h: Analog input</li> <li>- 72h: Digital output</li> <li>- 73h: Analog output</li> <li>- 74h: Analog input/-output</li> <li>- 76h: Counter</li> </ul> </li> <li>■ Bit 7: reserved</li> </ul>

**NUMBIT Diagnostic bits**

Byte	Bit 7 ... 0
0	Number of diagnostic bits per channel (here 08h)

**NUMCH Channels**

Byte	Bit 7 ... 0
0	Number of channels of a module (here 02h)

**CHERR Channel error**

Byte	Bit 7 ... 0
0	<ul style="list-style-type: none"> <li>■ Bit 0: set at error in channel group 0</li> <li>■ Bit 1: set at error in channel group 1</li> <li>■ Bit 7 ... 2: reserved</li> </ul>

**CH0ERR / CH1ERR  
Channel specific**

Byte	Bit 7 ... 0
0	Channel-specific error channel x: <ul style="list-style-type: none"> <li>■ Bit 0: set at configuring/parameter assignment error</li> <li>■ Bit 2 ... 1: reserved</li> <li>■ Bit 3: set at short-circuit to ground</li> <li>■ Bit 7 ... 4: reserved</li> </ul>

**CH2ERR ... CH7ERR  
reserved**

Byte	Bit 7 ... 0
0	reserved

**DIAG\_US  $\mu$ s ticker**

Byte	Bit 7 ... 0
0...3	Value of the $\mu$ s ticker at the moment of the diagnostic

 **$\mu$ s ticker**

In the System SLIO module there is a timer ( $\mu$ s ticker). With PowerON the timer starts counting with 0. After  $2^{32}-1\mu$ s the timer starts with 0 again.

032-1BB40 - AO 2x12Bit 0(4)...20mA

### 4.5 032-1BB40 - AO 2x12Bit 0(4)...20mA

#### Properties

The electronic module has 2 outputs with parameterizable functions. The channels of the module are electrically isolated from the backplane bus. In addition, the channels are isolated to the DC 24V power supply by means of DC/DC converter.

- 2 analog outputs
- Suited for sensors with 0 ... 20mA; 4 ... 20mA
- Diagnostics function
- 12bit resolution

#### Structure

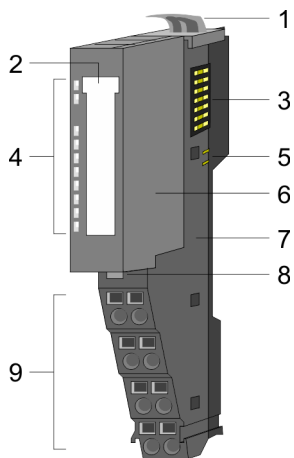

- 1 Locking lever terminal module
- 2 Labeling strip
- 3 Backplane bus
- 4 LED status indication
- 5 DC 24V power section supply
- 6 Electronic module
- 7 Terminal module
- 8 Locking lever electronic module
- 9 Terminal

#### Status indication

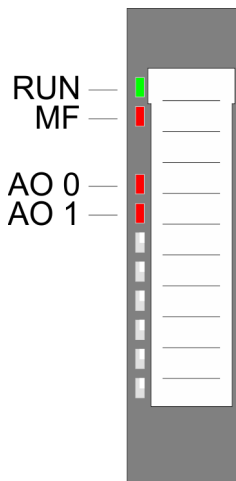

RUN	MF	AO x	Description
<input checked="" type="checkbox"/> green	<input checked="" type="checkbox"/> red	<input checked="" type="checkbox"/> red	
<input checked="" type="checkbox"/>	<input type="checkbox"/>	X	Bus communication is OK Module status is OK
<input checked="" type="checkbox"/>	<input checked="" type="checkbox"/>	X	Bus communication is OK Module status reports an error
<input type="checkbox"/>	<input checked="" type="checkbox"/>	X	Bus communication is not possible Module status reports an error
<input type="checkbox"/>	<input type="checkbox"/>	X	Error at bus power supply
X	<input checked="" type="checkbox"/>	X	Error in configuration → <a href="#">‘Trouble shooting - LEDs’...page 41</a>
<input checked="" type="checkbox"/>	<input type="checkbox"/>	<input checked="" type="checkbox"/>	Error channel x <ul style="list-style-type: none"> <li>■ Error in parameterization</li> <li>■ Wire break (if parameterized)</li> </ul>
not relevant: X			

**Pin assignment**

For wires with a cross section of 0.08mm<sup>2</sup> up to 1.5mm<sup>2</sup>.

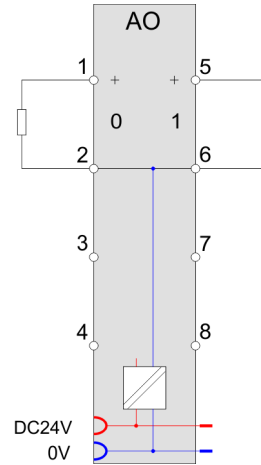
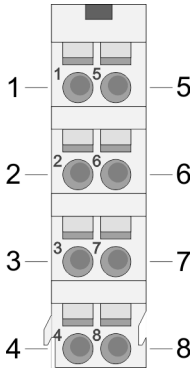

Pos.	Function	Type	Description
1	AO 0	O	Channel 0
2	AGND	O	Ground channels
3	---	---	not connected
4	---	---	not connected
5	AO 1	O	Channel 1
6	AGND	O	Ground channels
7	---	---	not connected
8	---	---	not connected

O: Output

**Input area**

No byte of the input area is used by the module.

**Output area**

At CPU, PROFIBUS and PROFINET the output area is embedded to the corresponding address area.

IX Index for access via CANopen with s = Subindex, depends on number and type of analog modules

SX Subindex for access via EtherCAT with Index 7000h + EtherCAT-Slot

More can be found in the according manual of your bus coupler.

Addr.	Name	Bytes	Function	IX	SX
+0	AO 0	2	Analog value channel 0	6411h/s	01h
+2	AO 1	2	Analog value channel 1	6411h/s+1	02h

## 4.5.1 Technical data

Order no.	032-1BB40
Type	SM 032 - Analog output
Module ID	0502 25D8
<b>Current consumption/power loss</b>	
Current consumption from backplane bus	85 mA
Current consumption from load voltage L+ (without load)	15 mA
Power loss	0.8 W
<b>Technical data analog outputs</b>	
Number of outputs	2
Cable length, shielded	200 m
Rated load voltage	DC 24 V
Reverse polarity protection of rated load voltage	✓
Current consumption from rated load voltage	-
Voltage output short-circuit protection	-
Voltage outputs	-
Min. load resistance (voltage range)	-
Max. capacitive load (current range)	-
Max. inductive load (current range)	-
Output voltage ranges	-
Operational limit of voltage ranges	-
Basic error limit voltage ranges	-
Destruction limit against external applied voltage	-
Current outputs	✓
Max. in load resistance (current range)	350 Ω
Max. inductive load (current range)	10 mH
Typ. open circuit voltage current output	12 V
Output current ranges	0 mA ... +20 mA +4 mA ... +20 mA
Operational limit of current ranges	+/-0.4% ... +/-0.5%
Basic error limit current ranges	+/-0.2% ... +/-0.3%
Destruction limit against external applied voltage	max. 12V (30V for 1s)
Settling time for ohmic load	0.25 ms
Settling time for capacitive load	-
Settling time for inductive load	1.5 ms
Resolution in bit	12
Conversion time	2 ms all channels
Substitute value can be applied	no
Output data size	4 Byte

Order no.	032-1BB40
<b>Status information, alarms, diagnostics</b>	
Status display	yes
Interrupts	no
Process alarm	no
Diagnostic interrupt	no
Diagnostic functions	yes
Diagnostics information read-out	possible
Supply voltage display	green LED
Group error display	red LED
Channel error display	red LED per channel
<b>Isolation</b>	
Between channels	-
Between channels of groups to	-
Between channels and backplane bus	✓
Between channels and power supply	✓
Max. potential difference between circuits	-
Max. potential difference between inputs (U <sub>cm</sub> )	-
Max. potential difference between Mana and Mintern (U <sub>iso</sub> )	DC 75 V/ AC 50 V
Max. potential difference between inputs and Mana (U <sub>cm</sub> )	-
Max. potential difference between inputs and Mintern (U <sub>iso</sub> )	-
Max. potential difference between Mintern and outputs	-
Insulation tested with	DC 500 V
<b>Datasizes</b>	
Input bytes	0
Output bytes	4
Parameter bytes	8
Diagnostic bytes	20
<b>Housing</b>	
Material	PPE / PPE GF10
Mounting	Profile rail 35 mm
<b>Mechanical data</b>	
Dimensions (WxHxD)	12.9 mm x 109 mm x 76.5 mm
Net weight	61 g
Weight including accessories	61 g
Gross weight	75 g
<b>Environmental conditions</b>	

032-1BB40 - AO 2x12Bit 0(4)...20mA &gt; Parameter data

<b>Order no.</b>	<b>032-1BB40</b>
Operating temperature	0 °C to 60 °C
Storage temperature	-25 °C to 70 °C
<b>Certifications</b>	
UL certification	yes
KC certification	yes
UKCA certification	yes
ChinaRoHS certification	yes

#### 4.5.2 Parameter data

DS Record set for access via CPU, PROFIBUS and PROFINET

IX Index for access via CANopen

SX Subindex for access via EtherCAT with Index 3100h + EtherCAT-Slot

More can be found in the according manual of your bus coupler.

Name	Bytes	Function	Default	DS	IX	SX
RES0	1	reserved	00h	00h	3100h	01h
WIBRK_EN	1	Wire-break recognition	00h	00h	3101h	02h
CH0FN	1	Function number channel 0	31h	80h	3102h	03h
CH1FN	1	Function number channel 1	31h	81h	3103h	04h

#### WIBRK\_EN Wire-break recognition

You also can activate the wire-break recognition for the current output range 0 ... 20mA. To ensure a safe wire-break recognition, the decimal value for the output is  $\geq 100$ .

Byte	Bit 7 ... 0
0	<ul style="list-style-type: none"> <li>■ Bit 0: Wire-break recognition channel 0 (1: on)</li> <li>■ Bit 1: Wire-break recognition channel 1 (1: on)</li> <li>■ Bit 7 ... 2: reserved</li> </ul>

#### CHxFN Function number channel x

In the following there are the measuring ranges with corresponding function number listed, which were supported by the analog module. With FFh the corresponding channel is deactivated. The formulas listed here allow you to transform an evaluated measuring value (digital value) to a value assigned to the measuring range (analog value) and vice versa.

Output range current 0 ... 20mA (funct. no.)	Current (I)	Decimal (D)	Hex	Range	Formulas
0 ... 20mA Siemens S7 format (31h)	23.52mA	32511	7EFFh	overrange	$I = D \times \frac{20}{27648}$ $D = 27648 \times \frac{I}{20}$
	20mA	27648	6C00h	nominal range	
	10mA	13824	3600h		
	0mA	0	0000h		
	Not possible, is limited to 0mA.			underrange	
0 ... 20mA Siemens S5 format (41h)	25.00mA	20480	5000h	overrange	$I = D \times \frac{20}{16384}$ $D = 16384 \times \frac{I}{20}$
	20mA	16384	4000h	nominal range	
	10mA	8192	2000h		
	0mA	0	0000h		
	Not possible, is limited to 0mA.			underrange	

Output range current 4 ... 20mA (funct. no.)	Current (I)	Decimal (D)	Hex	Range	Formulas
4 ... 20mA Siemens S7 format (30h)	22.81mA	32511	7EFFh	overrange	$I = D \times \frac{16}{27648} + 4$ $D = 27648 \times \frac{I-4}{16}$
	20mA	27648	6C00h	nominal range	
	12mA	13824	3600h		
	4mA	0	0000h		
	0mA	-6912	E500h	underrange	
4 ... 20mA Siemens S5 format (40h)	24.00mA	20480	5000h	overrange	$I = D \times \frac{16}{16384} + 4$ $D = 16384 \times \frac{I-4}{16}$
	20mA	16384	4000h	nominal range	
	12mA	8192	2000h		
	4mA	0	0000h		
	0mA	-4096	F000h	underrange	

### 4.5.3 Diagnostic data

So this module does not support diagnostic interrupt functions, the diagnostics data serve for information about this module. On error the corresponding channel LED of the module is activated and the error is registered in the diagnostics data.

The following errors are listed in the diagnostics data:

- Error in project engineering / parameterization
- Wire-break (if parameterized)

032-1BB40 - AO 2x12Bit 0(4)...20mA &gt; Diagnostic data

- DS Record set for access via CPU, PROFIBUS and PROFINET. The access happens by DS 01h. Additionally the first 4 bytes may be accessed by DS 00h.
- IX Index for access via CANopen. The access happens by IX 2F01h. Additionally the first 4 bytes may be accessed by IX 2F00h.
- SX Subindex for access via EtherCAT with Index 5005h.
- More can be found in the according manual of your bus coupler.

Name	Bytes	Function	Default	DS	IX	SX
ERR_A	1	Diagnostic	00h	01h	2F01h	02h
MODTYP	1	Module information	15h			03h
ERR_C	1	reserved	00h			04h
ERR_D	1	Diagnostic	00h			05h
CHTYP	1	Channel type	73h			06h
NUMBIT	1	Number diagnostic bits per channel	08h			07h
NUMCH	1	Number of channels of a module	02h			08h
CHERR	1	Channel error	00h			09h
CH0ERR	1	Channel-specific error channel 0	00h			0Ah
CH1ERR	1	Channel-specific error channel 1	00h			0Bh
CH2ERR... CH7ERR	6	reserved	00h			0Ch ... 11h
DIAG_US	4	µs ticker	00h			13h

**ERR\_A Diagnostic**

Byte	Bit 7 ... 0
0	<ul style="list-style-type: none"> <li>■ Bit 0: set at module failure</li> <li>■ Bit 1: set at internal error</li> <li>■ Bit 2: set at external error</li> <li>■ Bit 3: set at channel error</li> <li>■ Bit 4: set at external auxiliary supply missing</li> <li>■ Bit 6 ... 5: reserved</li> <li>■ Bit 7: set at error in parametrization</li> </ul>

**MODTYP  
Module information**

Byte	Bit 7 ... 0
0	<ul style="list-style-type: none"> <li>■ Bit 3 ... 0: module class <ul style="list-style-type: none"> <li>- 0101b analog module</li> </ul> </li> <li>■ Bit 4: set at channel information present</li> <li>■ Bit 7 ... 5: reserved</li> </ul>



**ERR\_D Diagnostic**

Byte	Bit 7 ... 0
0	<ul style="list-style-type: none"> <li>■ Bit 2 ... 0: reserved</li> <li>■ Bit 3: set at internal diagnostics buffer overflow</li> <li>■ Bit 4: set at internal communication error</li> <li>■ Bit 7 ... 5: reserved</li> </ul>

**CHTYP Channel type**

Byte	Bit 7 ... 0
0	<ul style="list-style-type: none"> <li>■ Bit 6 ... 0: Channel type <ul style="list-style-type: none"> <li>- 70h: Digital input</li> <li>- 71h: Analog input</li> <li>- 72h: Digital output</li> <li>- 73h: Analog output</li> <li>- 74h: Analog input/-output</li> <li>- 76h: Counter</li> </ul> </li> <li>■ Bit 7: reserved</li> </ul>

**NUMBIT Diagnostic bits**

Byte	Bit 7 ... 0
0	Number of diagnostic bits per channel (here 08h)

**NUMCH Channels**

Byte	Bit 7 ... 0
0	Number of channels of a module (here 02h)

**CHERR Channel error**

Byte	Bit 7 ... 0
0	<ul style="list-style-type: none"> <li>■ Bit 0: set at error in channel group 0</li> <li>■ Bit 1: set at error in channel group 1</li> <li>■ Bit 7 ... 2: reserved</li> </ul>

**CH0ERR / CH1ERR  
Channel-specific**

Byte	Bit 7 ... 0
0	Channel-specific error channel x <ul style="list-style-type: none"> <li>■ Bit 0: set at configuring/parameter assignment error</li> <li>■ Bit 3 ... 1: reserved</li> <li>■ Bit 4: set at wire-break</li> <li>■ Bit 7 ... 5: reserved</li> </ul>

**CH2ERR ... CH7ERR  
reserved**

Byte	Bit 7 ... 0
0	reserved

032-1BB40 - AO 2x12Bit 0(4)...20mA > Diagnostic data

**DIAG\_US  $\mu$ s ticker**

Byte	Bit 7 ... 0
0...3	Value of the $\mu$ s ticker at the moment of the diagnostic

 *$\mu$ s ticker*

In the System SLIO module there is a timer ( $\mu$ s ticker). With PowerON the timer starts counting with 0. After  $2^{32}-1\mu$ s the timer starts with 0 again.

### 4.6 032-1BB70 - AO 2x12Bit ±10V

**Properties**

The electronic module has 2 outputs with parameterizable functions. The channels of the module are electrically isolated from the backplane bus. In addition, the channels are isolated to the DC 24V power supply by means of DC/DC converter.

- 2 analog outputs
- Suited for sensors with ±10V, 0 ... 10V
- Diagnostics function
- 12bit resolution

**Structure**

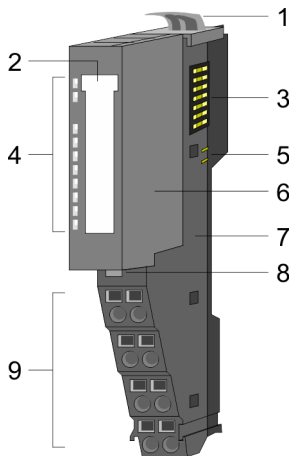

- 1 Locking lever terminal module
- 2 Labeling strip
- 3 Backplane bus
- 4 LED status indication
- 5 DC 24V power section supply
- 6 Electronic module
- 7 Terminal module
- 8 Locking lever electronic module
- 9 Terminal

**Status indication**

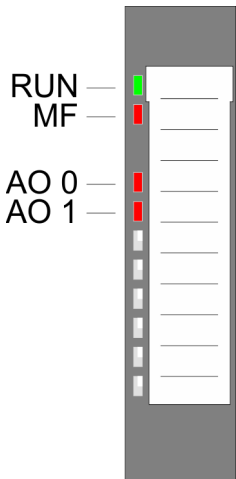

RUN	MF	AO x	Description
<input checked="" type="checkbox"/> green	<input checked="" type="checkbox"/> red	<input checked="" type="checkbox"/> red	
<input checked="" type="checkbox"/>	<input type="checkbox"/>	X	Bus communication is OK Module status is OK
<input checked="" type="checkbox"/>	<input checked="" type="checkbox"/>	X	Bus communication is OK Module status reports an error
<input type="checkbox"/>	<input checked="" type="checkbox"/>	X	Bus communication is not possible Module status reports an error
<input type="checkbox"/>	<input type="checkbox"/>	X	Error at bus power supply
X	<input checked="" type="checkbox"/>	X	Error in configuration → <a href="#">‘Trouble shooting - LEDs’...page 41</a>
<input checked="" type="checkbox"/>	<input type="checkbox"/>	<input checked="" type="checkbox"/>	Error channel x <ul style="list-style-type: none"> <li>■ Overload, short-circuit</li> <li>■ Error in parameterization</li> </ul>
not relevant: X			

032-1BB70 - AO 2x12Bit ±10V

**Pin assignment**

For wires with a cross section of 0.08mm<sup>2</sup> up to 1.5mm<sup>2</sup>.

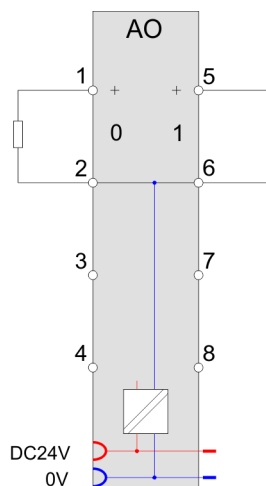
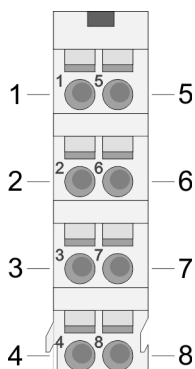

Pos.	Function	Type	Description
1	AO 0	O	Channel 0
2	AGND	O	Ground channels
3	---	---	not connected
4	---	---	not connected
5	AO 1	O	Channel 1
6	AGND	O	Ground channels
7	---	---	not connected
8	---	---	not connected

O: Output

**Input area**

No byte of the input area is used by the module.

**Output area**

At CPU, PROFIBUS and PROFINET the output area is embedded to the corresponding address area.

IX Index for access via CANopen with s = Subindex, depends on number and type of analog modules

SX Subindex for access via EtherCAT with Index 7000h + EtherCAT-Slot

More can be found in the according manual of your bus coupler.

Addr.	Name	Bytes	Function	IX	SX
+0	AO 0	2	Analog value channel 0	6411h/s	01h
+2	AO 1	2	Analog value channel 1	6411h/s+1	02h

## 4.6.1 Technical data

Order no.	032-1BB70
Type	SM 032 - Analog output
Module ID	0505 25D8
<b>Current consumption/power loss</b>	
Current consumption from backplane bus	60 mA
Current consumption from load voltage L+ (without load)	20 mA
Power loss	0.8 W
<b>Technical data analog outputs</b>	
Number of outputs	2
Cable length, shielded	200 m
Rated load voltage	DC 24 V
Reverse polarity protection of rated load voltage	✓
Current consumption from rated load voltage	-
Voltage output short-circuit protection	✓
Voltage outputs	✓
Min. load resistance (voltage range)	5 k $\Omega$
Max. capacitive load (current range)	1 $\mu$ F
Max. inductive load (current range)	10 mA
Output voltage ranges	-10 V ... +10 V 0 V ... +10 V
Operational limit of voltage ranges	+/-0.3%
Basic error limit voltage ranges	+/-0.2%
Destruction limit against external applied voltage	max. 24V
Current outputs	-
Max. in load resistance (current range)	-
Max. inductive load (current range)	-
Typ. open circuit voltage current output	-
Output current ranges	-
Operational limit of current ranges	-
Basic error limit current ranges	-
Destruction limit against external applied voltage	-
Settling time for ohmic load	3 ms
Settling time for capacitive load	3 ms
Settling time for inductive load	-
Resolution in bit	12
Conversion time	2 ms all channels
Substitute value can be applied	no
Output data size	4 Byte

032-1BB70 - AO 2x12Bit  $\pm 10V$  > Technical data

Order no.	032-1BB70
<b>Status information, alarms, diagnostics</b>	
Status display	yes
Interrupts	no
Process alarm	no
Diagnostic interrupt	no
Diagnostic functions	yes
Diagnostics information read-out	possible
Supply voltage display	green LED
Group error display	red LED
Channel error display	red LED per channel
<b>Isolation</b>	
Between channels	-
Between channels of groups to	-
Between channels and backplane bus	✓
Between channels and power supply	✓
Max. potential difference between circuits	-
Max. potential difference between inputs (Ucm)	-
Max. potential difference between Mana and Mintern (Uiso)	DC 75 V/ AC 50 V
Max. potential difference between inputs and Mana (Ucm)	-
Max. potential difference between inputs and Mintern (Uiso)	-
Max. potential difference between Mintern and outputs	-
Insulation tested with	DC 500 V
<b>Datasizes</b>	
Input bytes	0
Output bytes	4
Parameter bytes	8
Diagnostic bytes	20
<b>Housing</b>	
Material	PPE / PPE GF10
Mounting	Profile rail 35 mm
<b>Mechanical data</b>	
Dimensions (WxHxD)	12.9 mm x 109 mm x 76.5 mm
Net weight	58 g
Weight including accessories	58 g
Gross weight	73 g
<b>Environmental conditions</b>	

<b>Order no.</b>	<b>032-1BB70</b>
Operating temperature	0 °C to 60 °C
Storage temperature	-25 °C to 70 °C
<b>Certifications</b>	
UL certification	yes
KC certification	yes
UKCA certification	yes
ChinaRoHS certification	yes

#### 4.6.2 Parameter data

- DS Record set for access via CPU, PROFIBUS and PROFINET  
 IX Index for access via CANopen  
 SX Subindex for access via EtherCAT with Index 3100h + EtherCAT-Slot  
 More can be found in the according manual of your bus coupler.

Name	Bytes	Function	Default	DS	IX	SX
RES0	1	reserved	00h	00h	3100h	01h
SHORT_EN	1	Short-circuit recognition	00h	00h	3101h	02h
CH0FN	1	Function number channel 0	12h	80h	3102h	03h
CH1FN	1	Function number channel 1	12h	81h	3103h	04h

#### SHORT\_EN Short-circuit recognition

Byte	Bit 7 ... 0
0	<ul style="list-style-type: none"> <li>■ Bit 0: Short-circuit recognition channel 0 (1:on)</li> <li>■ Bit 1: Short-circuit recognition channel 1 (1:on)</li> <li>■ Bit 7 ... 2: reserved</li> </ul>

#### CHxFN Function number channel x

In the following there are the measuring ranges with corresponding function number listed, which were supported by the analog module. With FFh the corresponding channel is deactivated. The formulas listed here allow you to transform an evaluated measuring value (digital value) to a value assigned to the measuring range (analog value) and vice versa.

032-1BB70 - AO 2x12Bit ±10V &gt; Diagnostic data

Output range voltage ±10V (funct. no.)	Voltage (U)	Decimal (D)	Hex	Range	Formulas
±10V Siemens S7 format (12h)	11.76V	32511	7EFFh	overrange	$U = D \times \frac{10}{27648}$ $D = 27648 \times \frac{U}{10}$
	10V	27648	6C00h	nominal range	
	5V	13824	3600h		
	0V	0	0000h		
	-5V	-13824	CA00h		
	-10V	-27648	9400h		
	-11.76V	-32512	8100h	underrange	
±10V Siemens S5 format (22h)	12.5V	20480	5000h	overrange	$U = D \times \frac{10}{16384}$ $D = 16384 \times \frac{U}{10}$
	10V	16384	4000h	nominal range	
	5V	8192	2000h		
	0V	0	0000h		
	-5V	-8192	E000h		
	-10V	-16384	C000h		
	-12.5V	-20480	B000h	underrange	

Output range voltage 0 ... 10V (funct. no.)	Voltage (U)	Decimal (D)	Hex	Range	Formulas
0 ... 10V Siemens S7 format (10h)	11.76V	32511	7EFFh	overrange	$U = D \times \frac{10}{27648}$ $D = 27648 \times \frac{U}{10}$
	10V	27648	6C00h	nominal range	
	5V	13824	3600h		
	0V	0	0000h		
	Not possible, is limited to 0V.				
0 ... 10V Siemens S5 format (20h)	12.5V	20480	5000h	overrange	$U = D \times \frac{10}{16384}$ $D = 16384 \times \frac{U}{10}$
	10V	16384	4000h	nominal range	
	5V	8192	2000h		
	0V	0	0000h		
	Not possible, is limited to 0V.				

### 4.6.3 Diagnostic data

So this module does not support diagnostic interrupt functions, the diagnostics data serve for information about this module. On error the corresponding channel LED of the module is activated and the error is registered in the diagnostics data.

The following errors are listed in the diagnostics data:

- Error in project engineering / parameterization
- Short-circuit/overload (if parameterized)



- DS Record set for access via CPU, PROFIBUS and PROFINET. The access happens by DS 01h. Additionally the first 4 bytes may be accessed by DS 00h.
- IX Index for access via CANopen. The access happens by IX 2F01h. Additionally the first 4 bytes may be accessed by IX 2F00h.
- SX Subindex for access via EtherCAT with Index 5005h.
- More can be found in the according manual of your bus coupler.

Name	Bytes	Function	Default	DS	IX	SX
ERR_A	1	Diagnostic	00h	01h	2F01h	02h
MODTYP	1	Module information	15h			03h
ERR_C	1	reserved	00h			04h
ERR_D	1	Diagnostic	00h			05h
CHTYP	1	Channel type	73h			06h
NUMBIT	1	Number diagnostic bits per channel	08h			07h
NUMCH	1	Number of channels of a module	02h			08h
CHERR	1	Channel error	00h			09h
CH0ERR	1	Channel-specific error channel 0	00h			0Ah
CH1ERR	1	Channel-specific error channel 1	00h			0Bh
CH2ERR... CH7ERR	6	reserved	00h			0Ch ... 11h
DIAG_US	4	µs ticker	00h			13h

**ERR\_A Diagnostic**

Byte	Bit 7 ... 0
0	<ul style="list-style-type: none"> <li>■ Bit 0: set at module failure</li> <li>■ Bit 1: set at internal error</li> <li>■ Bit 2: set at external error</li> <li>■ Bit 3: set at channel error</li> <li>■ Bit 4: set at external auxiliary supply missing</li> <li>■ Bit 6 ... 5: reserved</li> <li>■ Bit 7: set at error in parametrization</li> </ul>

**MODTYP  
Module information**

Byte	Bit 7 ... 0
0	<ul style="list-style-type: none"> <li>■ Bit 3 ... 0: module class <ul style="list-style-type: none"> <li>- 0101b analog module</li> </ul> </li> <li>■ Bit 4: set at channel information present</li> <li>■ Bit 7 ... 5: reserved</li> </ul>

032-1BB70 - AO 2x12Bit ±10V &gt; Diagnostic data

**ERR\_D Diagnostic**

Byte	Bit 7 ... 0
0	<ul style="list-style-type: none"> <li>■ Bit 2 ... 0: reserved</li> <li>■ Bit 3: set at internal diagnostics buffer overflow</li> <li>■ Bit 4: set at internal communication error</li> <li>■ Bit 7 ... 5: reserved</li> </ul>

**CHTYP Channel type**

Byte	Bit 7 ... 0
0	<ul style="list-style-type: none"> <li>■ Bit 6 ... 0: Channel type <ul style="list-style-type: none"> <li>- 70h: Digital input</li> <li>- 71h: Analog input</li> <li>- 72h: Digital output</li> <li>- 73h: Analog output</li> <li>- 74h: Analog input/-output</li> <li>- 76h: Counter</li> </ul> </li> <li>■ Bit 7: reserved</li> </ul>

**NUMBIT Diagnostic bits**

Byte	Bit 7 ... 0
0	Number of diagnostic bits per channel (here 08h)

**NUMCH Channels**

Byte	Bit 7 ... 0
0	Number of channels of a module (here 02h)

**CHERR Channel error**

Byte	Bit 7 ... 0
0	<ul style="list-style-type: none"> <li>■ Bit 0: set at error in channel group 0</li> <li>■ Bit 1: set at error in channel group 1</li> <li>■ Bit 7 ... 2: reserved</li> </ul>

**CH0ERR / CH1ERR  
Channel-specific**

Byte	Bit 7 ... 0
0	Channel-specific error channel x: <ul style="list-style-type: none"> <li>■ Bit 0: set at configuring/parameter assignment error</li> <li>■ Bit 2 ... 1: reserved</li> <li>■ Bit 3: set at short-circuit to ground</li> <li>■ Bit 7 ... 4: reserved</li> </ul>

**CH2ERR ... CH7ERR  
reserved**

Byte	Bit 7 ... 0
0	reserved

**DIAG\_US  $\mu s$  ticker**

Byte	Bit 7 ... 0
0...3	Value of the $\mu s$ ticker at the moment of the diagnostic

 **$\mu s$  ticker**

In the System SLIO module there is a timer ( $\mu s$  ticker). With PowerON the timer starts counting with 0. After  $2^{32}-1\mu s$  the timer starts with 0 again.

032-1BD30 - AO 4x12Bit 0...10V

### 4.7 032-1BD30 - AO 4x12Bit 0...10V

#### Properties

The electronic module has 4 outputs with parameterizable functions. The channels of the module are electrically isolated from the backplane bus. In addition, the channels are isolated to the DC 24V power supply by means of DC/DC converter.

- 4 analog outputs
- Suited for sensors with 0 ... 10V
- Diagnostics function
- 12bit resolution

#### Structure

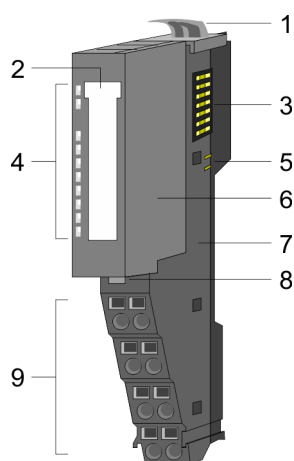

- 1 Locking lever terminal module
- 2 Labeling strip
- 3 Backplane bus
- 4 LED status indication
- 5 DC 24V power section supply
- 6 Electronic module
- 7 Terminal module
- 8 Locking lever electronic module
- 9 Terminal

#### Status indication

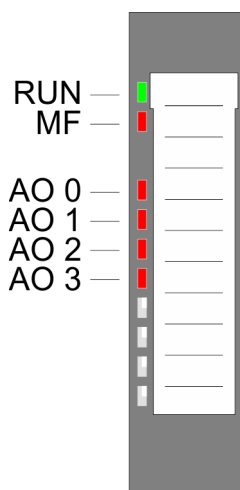

RUN	MF	AO x	Description
<input checked="" type="checkbox"/> green	<input checked="" type="checkbox"/> red	<input checked="" type="checkbox"/> red	
<input checked="" type="checkbox"/>	<input type="checkbox"/>	X	Bus communication is OK Module status is OK
<input checked="" type="checkbox"/>	<input checked="" type="checkbox"/>	X	Bus communication is OK Module status reports an error
<input type="checkbox"/>	<input checked="" type="checkbox"/>	X	Bus communication is not possible Module status reports an error
<input type="checkbox"/>	<input type="checkbox"/>	X	Error at bus power supply
X	<input checked="" type="checkbox"/>	X	Error in configuration → <a href="#">‘Trouble shooting - LEDs’...page 41</a>
<input checked="" type="checkbox"/>	<input type="checkbox"/>	<input checked="" type="checkbox"/>	Error channel x <ul style="list-style-type: none"> <li>■ Overload, short-circuit</li> <li>■ Error in parameterization</li> </ul>
not relevant: X			

**Pin assignment**

For wires with a cross section of 0.08mm<sup>2</sup> up to 1.5mm<sup>2</sup>.

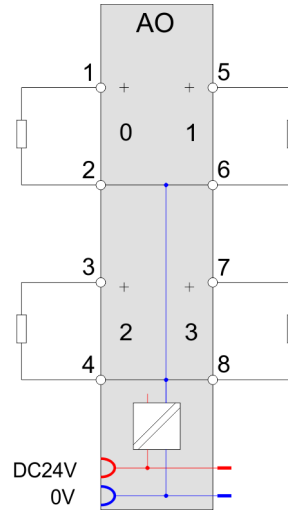
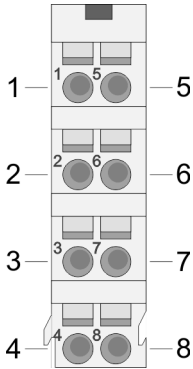

Pos.	Function	Type	Description
1	AO 0	O	Channel 0
2	AGND	O	Ground channels
3	AO 2	O	Channel 2
4	AGND	O	Ground channels
5	AO 1	O	Channel 1
6	AGND	O	Ground channels
7	AO 3	O	Channel 3
8	AGND	O	Ground channels

O: Output

**Input area**

No byte of the input area is used by the module.

**Output area**

At CPU, PROFIBUS and PROFINET the output area is embedded to the corresponding address area.

IX Index for access via CANopen with s = Subindex, depends on number and type of analog modules

SX Subindex for access via EtherCAT with Index 7000h + EtherCAT-Slot

More can be found in the according manual of your bus coupler.

Addr.	Name	Bytes	Function	IX	SX
+0	AO 0	2	Analog value channel 0	6411h/s	01h
+2	AO 1	2	Analog value channel 1	6411h/s+1	02h
+4	AO 2	2	Analog value channel 2	6411h/s+2	03h
+6	AO 3	2	Analog value channel 3	6411h/s+3	04h

## 4.7.1 Technical data

Order no.	032-1BD30
Type	SM 032 - Analog output
Module ID	0503 25E0
<b>Current consumption/power loss</b>	
Current consumption from backplane bus	90 mA
Current consumption from load voltage L+ (without load)	35 mA
Power loss	1.2 W
<b>Technical data analog outputs</b>	
Number of outputs	4
Cable length, shielded	200 m
Rated load voltage	DC 24 V
Reverse polarity protection of rated load voltage	✓
Current consumption from rated load voltage	-
Voltage output short-circuit protection	✓
Voltage outputs	✓
Min. load resistance (voltage range)	5 kΩ
Max. capacitive load (current range)	1 μF
Max. inductive load (current range)	10 mA
Output voltage ranges	0 V ... +10 V
Operational limit of voltage ranges	+/-0.3%
Basic error limit voltage ranges	+/-0.2%
Destruction limit against external applied voltage	max. 24V
Current outputs	-
Max. in load resistance (current range)	-
Max. inductive load (current range)	-
Typ. open circuit voltage current output	-
Output current ranges	-
Operational limit of current ranges	-
Basic error limit current ranges	-
Destruction limit against external applied voltage	-
Settling time for ohmic load	1.5 ms
Settling time for capacitive load	2 ms
Settling time for inductive load	-
Resolution in bit	12
Conversion time	2 ms all channels
Substitute value can be applied	no
Output data size	8 Byte
<b>Status information, alarms, diagnostics</b>	

Order no.	032-1BD30
Status display	yes
Interrupts	no
Process alarm	no
Diagnostic interrupt	no
Diagnostic functions	yes
Diagnostics information read-out	possible
Supply voltage display	green LED
Group error display	red LED
Channel error display	red LED per channel
<b>Isolation</b>	
Between channels	-
Between channels of groups to	-
Between channels and backplane bus	✓
Between channels and power supply	✓
Max. potential difference between circuits	-
Max. potential difference between inputs (U <sub>cm</sub> )	-
Max. potential difference between Mana and Mintern (U <sub>iso</sub> )	DC 75 V/ AC 50 V
Max. potential difference between inputs and Mana (U <sub>cm</sub> )	-
Max. potential difference between inputs and Mintern (U <sub>iso</sub> )	-
Max. potential difference between Mintern and outputs	-
Insulation tested with	DC 500 V
<b>Datasizes</b>	
Input bytes	0
Output bytes	8
Parameter bytes	10
Diagnostic bytes	20
<b>Housing</b>	
Material	PPE / PPE GF10
Mounting	Profile rail 35 mm
<b>Mechanical data</b>	
Dimensions (WxHxD)	12.9 mm x 109 mm x 76.5 mm
Net weight	61 g
Weight including accessories	61 g
Gross weight	75 g
<b>Environmental conditions</b>	
Operating temperature	0 °C to 60 °C

032-1BD30 - AO 4x12Bit 0...10V &gt; Parameter data

<b>Order no.</b>	<b>032-1BD30</b>
Storage temperature	-25 °C to 70 °C
<b>Certifications</b>	
UL certification	yes
KC certification	yes
UKCA certification	yes
ChinaRoHS certification	yes

#### 4.7.2 Parameter data

- DS Record set for access via CPU, PROFIBUS and PROFINET  
 IX Index for access via CANopen  
 SX Subindex for access via EtherCAT with Index 3100h + EtherCAT-Slot  
 More can be found in the according manual of your bus coupler.

Name	Bytes	Function	Default	DS	IX	SX
RES0	1	reserved	00h	00h	3100h	01h
SHORT_EN	1	Short-circuit recognition	00h	00h	3101h	02h
CH0FN	1	Function number channel 0	10h	80h	3102h	03h
CH1FN	1	Function number channel 1	10h	81h	3103h	04h
CH2FN	1	Function number channel 2	10h	82h	3104h	05h
CH3FN	1	Function number channel 3	10h	83h	3105h	06h

#### SHORT\_EN Short-circuit recognition

Byte	Bit 7 ... 0
0	<ul style="list-style-type: none"> <li>■ Bit 0: Short-circuit recognition channel 0 (1:on)</li> <li>■ Bit 1: Short-circuit recognition channel 1 (1:on)</li> <li>■ Bit 2: Short-circuit recognition channel 2 (1:on)</li> <li>■ Bit 3: Short-circuit recognition channel 3 (1:on)</li> <li>■ Bit 7 ... 4: reserved</li> </ul>

#### CHxFN Function number channel x

In the following there are the measuring ranges with corresponding function number listed, which were supported by the analog module. With FFh the corresponding channel is deactivated. The formulas listed here allow you to transform an evaluated measuring value (digital value) to a value assigned to the measuring range (analog value) and vice versa.



Output range voltage 0 ... 10V (funct. no.)	Voltage (U)	Decimal (D)	Hex	Range	Formulas
0 ... 10V Siemens S7 format (10h)	11.76V	32511	7EFFh	overrange	$U = D \times \frac{10}{27648}$ $D = 27648 \times \frac{U}{10}$
	10V	27648	6C00h	nominal range	
	5V	13824	3600h		
	0V	0	0000h		
	Not possible, is limited to 0V.				
0 ... 10V Siemens S5 format (20h)	12.5V	20480	5000h	overrange	$U = D \times \frac{10}{16384}$ $D = 16384 \times \frac{U}{10}$
	10V	16384	4000h	nominal range	
	5V	8192	2000h		
	0V	0	0000h		
	Not possible, is limited to 0V.				

### 4.7.3 Diagnostic data

So this module does not support diagnostic interrupt functions, the diagnostics data serve for information about this module. On error the corresponding channel LED of the module is activated and the error is registered in the diagnostics data.

The following errors are listed in the diagnostics data:

- Error in project engineering / parameterization
- Short-circuit/overload (if parameterized)

DS Record set for access via CPU, PROFIBUS and PROFINET. The access happens by DS 01h. Additionally the first 4 bytes may be accessed by DS 00h.

IX Index for access via CANopen. The access happens by IX 2F01h. Additionally the first 4 bytes may be accessed by IX 2F00h.

SX Subindex for access via EtherCAT with Index 5005h.

More can be found in the according manual of your bus coupler.

032-1BD30 - AO 4x12Bit 0...10V &gt; Diagnostic data

Name	Bytes	Function	Default	DS	IX	SX
ERR_A	1	Diagnostic	00h	01h	2F01h	02h
MODTYP	1	Module information	15h			03h
ERR_C	1	reserved	00h			04h
ERR_D	1	Diagnostic	00h			05h
CHTYP	1	Channel type	73h			06h
NUMBIT	1	Number diagnostic bits per channel	08h			07h
NUMCH	1	Number of channels of a module	04h			08h
CHERR	1	Channel error	00h			09h
CH0ERR	1	Channel-specific error channel 0	00h			0Ah
CH1ERR	1	Channel-specific error channel 1	00h			0Bh
CH2ERR	1	Channel-specific error channel 2	00h			0Ch
CH3ERR	1	Channel-specific error channel 3	00h			0Dh
CH4ERR... CH7ERR	4	reserved	00h			0Eh ... 11h
DIAG_US	4	µs ticker	00h			13h

**ERR\_A Diagnostic**

Byte	Bit 7 ... 0
0	<ul style="list-style-type: none"> <li>■ Bit 0: set at module failure</li> <li>■ Bit 1: set at internal error</li> <li>■ Bit 2: set at external error</li> <li>■ Bit 3: set at channel error</li> <li>■ Bit 4: set at external auxiliary supply missing</li> <li>■ Bit 6 ... 5: reserved</li> <li>■ Bit 7: set at error in parametrization</li> </ul>

**MODTYP  
Module information**

Byte	Bit 7 ... 0
0	<ul style="list-style-type: none"> <li>■ Bit 3 ... 0: module class <ul style="list-style-type: none"> <li>– 0101b analog module</li> </ul> </li> <li>■ Bit 4: set at channel information present</li> <li>■ Bit 7 ... 5: reserved</li> </ul>

**ERR\_D Diagnostic**

Byte	Bit 7 ... 0
0	<ul style="list-style-type: none"> <li>■ Bit 2 ... 0: reserved</li> <li>■ Bit 3: set at internal diagnostics buffer overflow</li> <li>■ Bit 4: set at internal communication error</li> <li>■ Bit 7 ... 5: reserved</li> </ul>

**CHTYP Channel type**

Byte	Bit 7 ... 0
0	<ul style="list-style-type: none"> <li>■ Bit 6 ... 0: Channel type               <ul style="list-style-type: none"> <li>- 70h: Digital input</li> <li>- 71h: Analog input</li> <li>- 72h: Digital output</li> <li>- 73h: Analog output</li> <li>- 74h: Analog input/-output</li> <li>- 76h: Counter</li> </ul> </li> <li>■ Bit 7: reserved</li> </ul>

**NUMBIT Diagnostic bits**

Byte	Bit 7 ... 0
0	Number of diagnostic bits per channel (here 08h)

**NUMCH Channels**

Byte	Bit 7 ... 0
0	Number of channels of a module (here 04h)

**CHERR Channel error**

Byte	Bit 7 ... 0
0	<ul style="list-style-type: none"> <li>■ Bit 0: set at error in channel group 0</li> <li>■ Bit 1: set at error in channel group 1</li> <li>■ Bit 2: set at error in channel group 2</li> <li>■ Bit 3: set at error in channel group 3</li> <li>■ Bit 7 ... 4: reserved</li> </ul>

**CH0ERR ... CH3ERR  
Channel-specific**

Byte	Bit 7 ... 0
0	Channel-specific error channel x: <ul style="list-style-type: none"> <li>■ Bit 0: set at configuring/parameter assignment error</li> <li>■ Bit 2 ... 1: reserved</li> <li>■ Bit 3: set at short-circuit to ground</li> <li>■ Bit 7 ... 4: reserved</li> </ul>

**CH4ERR ... CH7ERR  
reserved**

Byte	Bit 7 ... 0
0	reserved

**DIAG\_US  $\mu$ s ticker**

Byte	Bit 7 ... 0
0...3	Value of the $\mu$ s ticker at the moment of the diagnostic

 *$\mu$ s ticker*

In the System SLIO module there is a timer ( $\mu$ s ticker). With PowerON the timer starts counting with 0. After  $2^{32}-1\mu$ s the timer starts with 0 again.

032-1BD40 - AO 4x12Bit 0(4)...20mA

### 4.8 032-1BD40 - AO 4x12Bit 0(4)...20mA

**Properties**

The electronic module has 4 outputs with parameterizable functions. The channels of the module are electrically isolated from the backplane bus. In addition, the channels are isolated to the DC 24V power supply by means of DC/DC converter.

- 4 analog outputs
- Suited for sensors with 0...20mA; 4...20mA
- Diagnostics function
- 12bit resolution

**Structure**

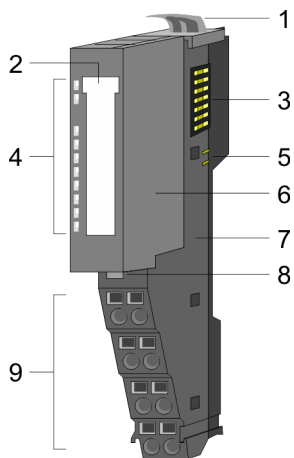

- 1 Locking lever terminal module
- 2 Labeling strip
- 3 Backplane bus
- 4 LED status indication
- 5 DC 24V power section supply
- 6 Electronic module
- 7 Terminal module
- 8 Locking lever electronic module
- 9 Terminal

**Status indication**

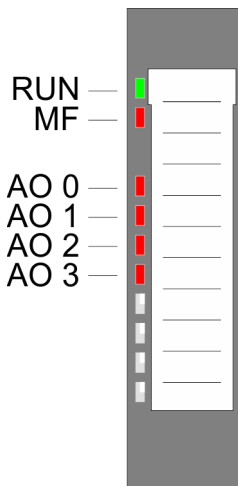

RUN	MF	AO x	Description
<input checked="" type="checkbox"/> green	<input checked="" type="checkbox"/> red	<input checked="" type="checkbox"/> red	
<input checked="" type="checkbox"/>	<input type="checkbox"/>	X	Bus communication is OK Module status is OK
<input checked="" type="checkbox"/>	<input checked="" type="checkbox"/>	X	Bus communication is OK Module status reports an error
<input type="checkbox"/>	<input checked="" type="checkbox"/>	X	Bus communication is not possible Module status reports an error
<input type="checkbox"/>	<input type="checkbox"/>	X	Error at bus power supply
X	<input checked="" type="checkbox"/>	X	Error in configuration → <a href="#">‘Trouble shooting - LEDs’...page 41</a>
<input checked="" type="checkbox"/>	<input type="checkbox"/>	<input checked="" type="checkbox"/>	Error channel x <ul style="list-style-type: none"> <li>■ Error in parameterization</li> <li>■ Wire break (if parameterized)</li> </ul>
not relevant: X			

**Pin assignment**

For wires with a cross section of 0.08mm<sup>2</sup> up to 1.5mm<sup>2</sup>.

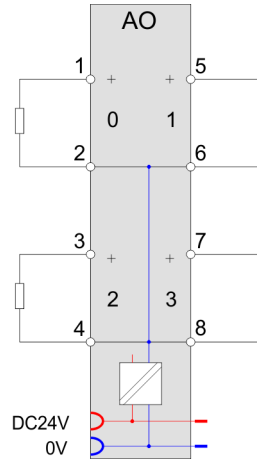
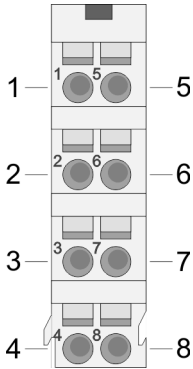

Pos.	Function	Type	Description
1	AO 0	O	Channel 0
2	AGND	O	Ground channels
3	AO 2	O	Channel 2
4	AGND	O	Ground channels
5	AO 1	O	Channel 1
6	AGND	O	Ground channels
7	AO 3	O	Channel 3
8	AGND	O	Ground channels

O: Output

**Input area**

No byte of the input area is used by the module.

**Output area**

At CPU, PROFIBUS and PROFINET the output area is embedded to the corresponding address area.

IX Index for access via CANopen with s = Subindex, depends on number and type of analog modules

SX Subindex for access via EtherCAT with Index 7000h + EtherCAT-Slot

More can be found in the according manual of your bus coupler.

Addr.	Name	Bytes	Function	IX	SX
+0	AO 0	2	Analog value channel 0	6411h/s	01h
+2	AO 1	2	Analog value channel 1	6411h/s+1	02h
+4	AO 2	2	Analog value channel 2	6411h/s+2	03h
+6	AO 3	2	Analog value channel 3	6411h/s+3	04h

## 4.8.1 Technical data

Order no.	032-1BD40
Type	SM 032 - Analog output
Module ID	0504 25E0
<b>Current consumption/power loss</b>	
Current consumption from backplane bus	90 mA
Current consumption from load voltage L+ (without load)	15 mA
Power loss	0.8 W
<b>Technical data analog outputs</b>	
Number of outputs	4
Cable length, shielded	200 m
Rated load voltage	DC 24 V
Reverse polarity protection of rated load voltage	✓
Current consumption from rated load voltage	-
Voltage output short-circuit protection	-
Voltage outputs	-
Min. load resistance (voltage range)	-
Max. capacitive load (current range)	-
Max. inductive load (current range)	-
Output voltage ranges	-
Operational limit of voltage ranges	-
Basic error limit voltage ranges	-
Destruction limit against external applied voltage	-
Current outputs	✓
Max. in load resistance (current range)	350 Ω
Max. inductive load (current range)	10 mH
Typ. open circuit voltage current output	12 V
Output current ranges	0 mA ... +20 mA +4 mA ... +20 mA
Operational limit of current ranges	+/-0.4% ... +/-0.5%
Basic error limit current ranges	+/-0.2% ... +/-0.3%
Destruction limit against external applied voltage	max. 12V (30V for 1s)
Settling time for ohmic load	0.25 ms
Settling time for capacitive load	-
Settling time for inductive load	1.5 ms
Resolution in bit	12
Conversion time	2 ms all channels
Substitute value can be applied	no
Output data size	8 Byte

Order no.	032-1BD40
<b>Status information, alarms, diagnostics</b>	
Status display	yes
Interrupts	no
Process alarm	no
Diagnostic interrupt	no
Diagnostic functions	yes
Diagnostics information read-out	possible
Supply voltage display	green LED
Group error display	red LED
Channel error display	red LED per channel
<b>Isolation</b>	
Between channels	-
Between channels of groups to	-
Between channels and backplane bus	✓
Between channels and power supply	✓
Max. potential difference between circuits	-
Max. potential difference between inputs (U <sub>cm</sub> )	-
Max. potential difference between Mana and Mintern (U <sub>iso</sub> )	DC 75 V/ AC 50 V
Max. potential difference between inputs and Mana (U <sub>cm</sub> )	-
Max. potential difference between inputs and Mintern (U <sub>iso</sub> )	-
Max. potential difference between Mintern and outputs	-
Insulation tested with	DC 500 V
<b>Datasizes</b>	
Input bytes	0
Output bytes	8
Parameter bytes	10
Diagnostic bytes	20
<b>Housing</b>	
Material	PPE / PPE GF10
Mounting	Profile rail 35 mm
<b>Mechanical data</b>	
Dimensions (WxHxD)	12.9 mm x 109 mm x 76.5 mm
Net weight	61 g
Weight including accessories	61 g
Gross weight	75 g
<b>Environmental conditions</b>	

032-1BD40 - AO 4x12Bit 0(4)...20mA &gt; Parameter data

<b>Order no.</b>	<b>032-1BD40</b>
Operating temperature	0 °C to 60 °C
Storage temperature	-25 °C to 70 °C
<b>Certifications</b>	
UL certification	yes
KC certification	yes
UKCA certification	yes
ChinaRoHS certification	yes

## 4.8.2 Parameter data

DS Record set for access via CPU, PROFIBUS and PROFINET

IX Index for access via CANopen

SX Subindex for access via EtherCAT with Index 3100h + EtherCAT-Slot

More can be found in the according manual of your bus coupler.

Name	Bytes	Function	Default	DS	IX	SX
RES0	1	reserved	00h	00h	3100h	01h
WIBRK_EN	1	Wire-break recognition	00h	00h	3101h	02h
CH0FN	1	Function number channel 0	31h	80h	3102h	03h
CH1FN	1	Function number channel 1	31h	81h	3103h	04h
CH2FN	1	Function number channel 2	31h	82h	3104h	05h
CH3FN	1	Function number channel 3	31h	83h	3105h	06h

### WIBRK\_EN Wire-break recognition

You also can activate the wire-break recognition for the current output range 0 ... 20mA. To ensure a safe wire-break recognition, the decimal value for the output is  $\geq 100$ .

Byte	Bit 7 ... 0
0	<ul style="list-style-type: none"> <li>■ Bit 0: Wire-break recognition channel 0 (1: on)</li> <li>■ Bit 1: Wire-break recognition channel 1 (1: on)</li> <li>■ Bit 2: Wire-break recognition channel 2 (1: on)</li> <li>■ Bit 3: Wire-break recognition channel 3 (1: on)</li> <li>■ Bit 7 ... 4: reserved</li> </ul>

### CHxFN Function number channel x

In the following there are the measuring ranges with corresponding function number listed, which were supported by the analog module. With FFh the corresponding channel is deactivated. The formulas listed here allow you to transform an evaluated measuring value (digital value) to a value assigned to the measuring range (analog value) and vice versa.



Output range current 0 ... 20mA (funct. no.)	Current (I)	Decimal (D)	Hex	Range	Formulas
0 ... 20mA Siemens S7 format (31h)	23.52mA	32511	7EFFh	overrange	$I = D \times \frac{20}{27648}$ $D = 27648 \times \frac{I}{20}$
	20mA	27648	6C00h	nominal range	
	10mA	13824	3600h		
	0mA	0	0000h		
	Not possible, is limited to 0mA.			underrange	
0 ... 20mA Siemens S5 format (41h)	25.00mA	20480	5000h	overrange	$I = D \times \frac{20}{16384}$ $D = 16384 \times \frac{I}{20}$
	20mA	16384	4000h	nominal range	
	10mA	8192	2000h		
	0mA	0	0000h		
	Not possible, is limited to 0mA.			underrange	

Output range current 4 ... 20mA (funct. no.)	Current (I)	Decimal (D)	Hex	Range	Formulas
4 ... 20mA Siemens S7 format (30h)	22.81mA	32511	7EFFh	overrange	$I = D \times \frac{16}{27648} + 4$ $D = 27648 \times \frac{I-4}{16}$
	20mA	27648	6C00h	nominal range	
	12mA	13824	3600h		
	4mA	0	0000h		
	0mA	-6912	E500h	underrange	
4 ... 20mA Siemens S5 format (40h)	24.00mA	20480	5000h	overrange	$I = D \times \frac{16}{16384} + 4$ $D = 16384 \times \frac{I-4}{16}$
	20mA	16384	4000h	nominal range	
	12mA	8192	2000h		
	4mA	0	0000h		
	0mA	-4096	F000h	underrange	

### 4.8.3 Diagnostic data

So this module does not support interrupt functions, the diagnostics data serve for information about this module. On error the corresponding channel LED of the module is activated and the error is registered in the diagnostics data.

The following errors are listed in the diagnostics data:

- Error in project engineering / parameterization
- Wire-break (if parameterized)

032-1BD40 - AO 4x12Bit 0(4)...20mA &gt; Diagnostic data

- DS Record set for access via CPU, PROFIBUS and PROFINET. The access happens by DS 01h. Additionally the first 4 bytes may be accessed by DS 00h.
- IX Index for access via CANopen. The access happens by IX 2F01h. Additionally the first 4 bytes may be accessed by IX 2F00h.
- SX Subindex for access via EtherCAT with Index 5005h.
- More can be found in the according manual of your bus coupler.

Name	Bytes	Function	Default	DS	IX	SX
ERR_A	1	Diagnostic	00h	01h	2F01h	02h
MODTYP	1	Module information	15h			03h
ERR_C	1	reserved	00h			04h
ERR_D	1	Diagnostic	00h			05h
CHTYP	1	Channel type	73h			06h
NUMBIT	1	Number diagnostic bits per channel	08h			07h
NUMCH	1	Number of channels of a module	04h			08h
CHERR	1	Channel error	00h			09h
CH0ERR	1	Channel-specific error channel 0	00h			0Ah
CH1ERR	1	Channel-specific error channel 1	00h			0Bh
CH2ERR	1	Channel-specific error channel 2	00h			0Ch
CH3ERR	1	Channel-specific error channel 3	00h			0Dh
CH4ERR... CH7ERR	4	reserved	00h			0Eh ... 11h
DIAG_US	4	µs ticker	00h			13h

**ERR\_A Diagnostic**

Byte	Bit 7 ... 0
0	<ul style="list-style-type: none"> <li>■ Bit 0: set at module failure</li> <li>■ Bit 1: set at internal error</li> <li>■ Bit 2: set at external error</li> <li>■ Bit 3: set at channel error</li> <li>■ Bit 4: set at external auxiliary supply missing</li> <li>■ Bit 6 ... 5: reserved</li> <li>■ Bit 7: set at error in parametrization</li> </ul>

**MODTYP  
Module information**

Byte	Bit 7 ... 0
0	<ul style="list-style-type: none"> <li>■ Bit 3 ... 0: module class <ul style="list-style-type: none"> <li>– 0101b analog module</li> </ul> </li> <li>■ Bit 4: set at channel information present</li> <li>■ Bit 7 ... 5: reserved</li> </ul>

**ERR\_D Diagnostic**

Byte	Bit 7 ... 0
0	<ul style="list-style-type: none"> <li>■ Bit 2 ... 0: reserved</li> <li>■ Bit 3: set at internal diagnostics buffer overflow</li> <li>■ Bit 4: set at internal communication error</li> <li>■ Bit 7 ... 5: reserved</li> </ul>

**CHTYP Channel type**

Byte	Bit 7 ... 0
0	<ul style="list-style-type: none"> <li>■ Bit 6 ... 0: Channel type <ul style="list-style-type: none"> <li>- 70h: Digital input</li> <li>- 71h: Analog input</li> <li>- 72h: Digital output</li> <li>- 73h: Analog output</li> <li>- 74h: Analog input/-output</li> <li>- 76h: Counter</li> </ul> </li> <li>■ Bit 7: reserved</li> </ul>

**NUMBIT Diagnostic bits**

Byte	Bit 7 ... 0
0	Number of diagnostic bits per channel (here 08h)

**NUMCH Channels**

Byte	Bit 7 ... 0
0	Number of channels of a module (here 04h)

**CHERR Channel error**

Byte	Bit 7 ... 0
0	<ul style="list-style-type: none"> <li>■ Bit 0: set at error in channel group 0</li> <li>■ Bit 1: set at error in channel group 1</li> <li>■ Bit 2: set at error in channel group 2</li> <li>■ Bit 3: set at error in channel group 3</li> <li>■ Bit 7 ... 4: reserved</li> </ul>

**CH0ERR ... CH3ERR  
Channel-specific**

Byte	Bit 7 ... 0
0	Channel-specific error channel x: <ul style="list-style-type: none"> <li>■ Bit 0: set at configuring/parameter assignment error</li> <li>■ Bit 3 ... 1: reserved</li> <li>■ Bit 4: set at wire-break</li> <li>■ Bit 7 ... 5: reserved</li> </ul>

032-1BD40 - AO 4x12Bit 0(4)...20mA > Diagnostic data

**DIAG\_US  $\mu$ s ticker**

Byte	Bit 7 ... 0
0...3	Value of the $\mu$ s ticker at the moment of the diagnostic

*$\mu$ s ticker*

In the System SLIO module there is a timer ( $\mu$ s ticker). With PowerON the timer starts counting with 0. After  $2^{32}-1\mu$ s the timer starts with 0 again.

### 4.9 032-1BD70 - AO 4x12Bit ±10V

**Properties**

The electronic module has 4 outputs with parameterizable functions. The channels of the module are electrically isolated from the backplane bus. In addition, the channels are isolated to the DC 24V power supply by means of DC/DC converter.

- 4 analog outputs
- Suited for sensors with ±10V, 0 ... 10V
- Diagnostics function
- 12bit resolution

**Structure**

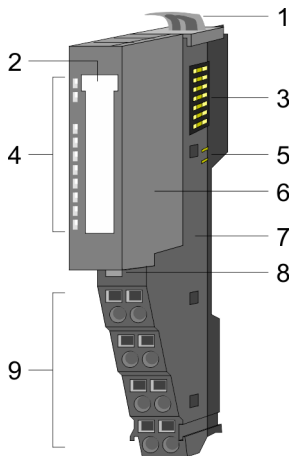

- 1 Locking lever terminal module
- 2 Labeling strip
- 3 Backplane bus
- 4 LED status indication
- 5 DC 24V power section supply
- 6 Electronic module
- 7 Terminal module
- 8 Locking lever electronic module
- 9 Terminal

**Status indication**

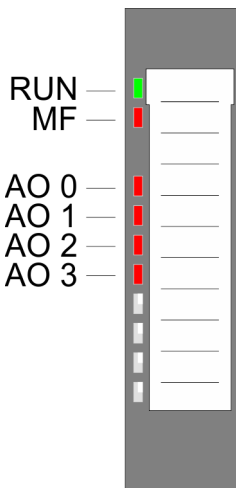

RUN	MF	AO x	Description
<input checked="" type="checkbox"/> green	<input checked="" type="checkbox"/> red	<input checked="" type="checkbox"/> red	
<input checked="" type="checkbox"/>	<input type="checkbox"/>	X	Bus communication is OK Module status is OK
<input checked="" type="checkbox"/>	<input checked="" type="checkbox"/>	X	Bus communication is OK Module status reports an error
<input type="checkbox"/>	<input checked="" type="checkbox"/>	X	Bus communication is not possible Module status reports an error
<input type="checkbox"/>	<input type="checkbox"/>	X	Error at bus power supply
X	<input checked="" type="checkbox"/>	X	Error in configuration → <a href="#">‘Trouble shooting - LEDs’...page 41</a>
<input checked="" type="checkbox"/>	<input type="checkbox"/>	<input checked="" type="checkbox"/>	Error channel x <ul style="list-style-type: none"> <li>■ Overload, short-circuit</li> <li>■ Error in parameterization</li> </ul>
not relevant: X			

032-1BD70 - AO 4x12Bit ±10V

**Pin assignment**

For wires with a cross section of 0.08mm<sup>2</sup> up to 1.5mm<sup>2</sup>.

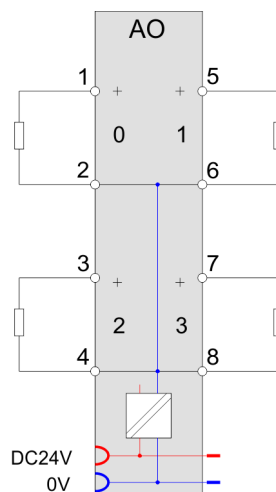
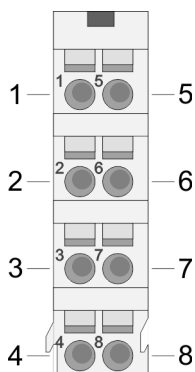

Pos.	Function	Type	Description
1	AO 0	O	Channel 0
2	AGND	O	Ground channels
3	AO 2	O	Channel 2
4	AGND	O	Ground channels
5	AO 1	O	Channel 1
6	AGND	O	Ground channels
7	AO 3	O	Channel 3
8	AGND	O	Ground channels

O: Output

**Input area**

No byte of the input area is used by the module.

**Output area**

At CPU, PROFIBUS and PROFINET the output area is embedded to the corresponding address area.

IX Index for access via CANopen with s = Subindex, depends on number and type of analog modules

SX Subindex for access via EtherCAT with Index 7000h + EtherCAT-Slot

More can be found in the according manual of your bus coupler.

Addr.	Name	Bytes	Function	IX	SX
+0	AO 0	2	Analog value channel 0	6411h/s	01h
+2	AO 1	2	Analog value channel 1	6411h/s+1	02h
+4	AO 2	2	Analog value channel 2	6411h/s+2	03h
+6	AO 3	2	Analog value channel 3	6411h/s+3	04h

## 4.9.1 Technical data

<b>Order no.</b>	<b>032-1BD70</b>
Type	SM 032 - Analog output
Module ID	0506 25E0
<b>Current consumption/power loss</b>	
Current consumption from backplane bus	60 mA
Current consumption from load voltage L+ (without load)	20 mA
Power loss	0.8 W
<b>Technical data analog outputs</b>	
Number of outputs	4
Cable length, shielded	200 m
Rated load voltage	DC 24 V
Reverse polarity protection of rated load voltage	✓
Current consumption from rated load voltage	-
Voltage output short-circuit protection	✓
Voltage outputs	✓
Min. load resistance (voltage range)	5 k $\Omega$
Max. capacitive load (current range)	1 $\mu$ F
Max. inductive load (current range)	10 mA
Output voltage ranges	-10 V ... +10 V 0 V ... +10 V
Operational limit of voltage ranges	+/-0.3%
Basic error limit voltage ranges	+/-0.2%
Destruction limit against external applied voltage	max. 24V
Current outputs	-
Max. in load resistance (current range)	-
Max. inductive load (current range)	-
Typ. open circuit voltage current output	-
Output current ranges	-
Operational limit of current ranges	-
Basic error limit current ranges	-
Destruction limit against external applied voltage	-
Settling time for ohmic load	3 ms
Settling time for capacitive load	3 ms
Settling time for inductive load	-
Resolution in bit	12
Conversion time	2 ms all channels
Substitute value can be applied	no
Output data size	8 Byte

032-1BD70 - AO 4x12Bit  $\pm 10V$  > Technical data

Order no.	032-1BD70
<b>Status information, alarms, diagnostics</b>	
Status display	yes
Interrupts	no
Process alarm	no
Diagnostic interrupt	no
Diagnostic functions	yes
Diagnostics information read-out	possible
Supply voltage display	green LED
Group error display	red LED
Channel error display	red LED per channel
<b>Isolation</b>	
Between channels	-
Between channels of groups to	-
Between channels and backplane bus	✓
Between channels and power supply	✓
Max. potential difference between circuits	-
Max. potential difference between inputs (Ucm)	-
Max. potential difference between Mana and Mintern (Uiso)	DC 75 V/ AC 50 V
Max. potential difference between inputs and Mana (Ucm)	-
Max. potential difference between inputs and Mintern (Uiso)	-
Max. potential difference between Mintern and outputs	-
Insulation tested with	DC 500 V
<b>Datasizes</b>	
Input bytes	0
Output bytes	8
Parameter bytes	10
Diagnostic bytes	20
<b>Housing</b>	
Material	PPE / PPE GF10
Mounting	Profile rail 35 mm
<b>Mechanical data</b>	
Dimensions (WxHxD)	12.9 mm x 109 mm x 76.5 mm
Net weight	62 g
Weight including accessories	62 g
Gross weight	76 g
<b>Environmental conditions</b>	



<b>Order no.</b>	<b>032-1BD70</b>
Operating temperature	0 °C to 60 °C
Storage temperature	-25 °C to 70 °C
<b>Certifications</b>	
UL certification	yes
KC certification	yes
UKCA certification	yes
ChinaRoHS certification	yes

## 4.9.2 Parameter data

- DS Record set for access via CPU, PROFIBUS and PROFINET  
 IX Index for access via CANopen  
 SX Subindex for access via EtherCAT with Index 3100h + EtherCAT-Slot  
 More can be found in the according manual of your bus coupler.

Name	Bytes	Function	Default	DS	IX	SX
RES0	1	reserved	00h	00h	3100h	01h
SHORT_EN	1	Short-circuit recognition	00h	00h	3101h	02h
CH0FN	1	Function number channel 0	12h	80h	3102h	03h
CH1FN	1	Function number channel 1	12h	81h	3103h	04h
CH2FN	1	Function number channel 2	12h	82h	3104h	05h
CH3FN	1	Function number channel 3	12h	83h	3105h	06h

### SHORT\_EN Short-circuit recognition

Byte	Bit 7 ... 0
0	<ul style="list-style-type: none"> <li>■ Bit 0: Short-circuit recognition channel 0 (1:on)</li> <li>■ Bit 1: Short-circuit recognition channel 1 (1:on)</li> <li>■ Bit 2: Short-circuit recognition channel 2 (1:on)</li> <li>■ Bit 3: Short-circuit recognition channel 3 (1:on)</li> <li>■ Bit 7 ... 4: reserved</li> </ul>

### CHxFN Function number channel x

In the following there are the measuring ranges with corresponding function number listed, which were supported by the analog module. With FFh the corresponding channel is deactivated. The formulas listed here allow you to transform an evaluated measuring value (digital value) to a value assigned to the measuring range (analog value) and vice versa.

032-1BD70 - AO 4x12Bit ±10V &gt; Diagnostic data

Output range voltage ±10V (funct. no.)	Voltage (U)	Decimal (D)	Hex	Range	Formulas
±10V Siemens S7 format (12h)	11.76V	32511	7EFFh	overrange	$U = D \times \frac{10}{27648}$ $D = 27648 \times \frac{U}{10}$
	10V	27648	6C00h	nominal range	
	5V	13824	3600h		
	0V	0	0000h		
	-5V	-13824	CA00h		
	-10V	-27648	9400h		
	-11.76V	-32512	8100h	underrange	
±10V Siemens S5 format (22h)	12.5V	20480	5000h	overrange	$U = D \times \frac{10}{16384}$ $D = 16384 \times \frac{U}{10}$
	10V	16384	4000h	nominal range	
	5V	8192	2000h		
	0V	0	0000h		
	-5V	-8192	E000h		
	-10V	-16384	C000h		
	-12.5V	-20480	B000h	underrange	

Output range voltage 0 ... 10V (funct. no.)	Voltage (U)	Decimal (D)	Hex	Range	Formulas
0 ... 10V Siemens S7 format (10h)	11.76V	32511	7EFFh	overrange	$U = D \times \frac{10}{27648}$ $D = 27648 \times \frac{U}{10}$
	10V	27648	6C00h	nominal range	
	5V	13824	3600h		
	0V	0	0000h		
	Not possible, is limited to 0V.				
0 ... 10V Siemens S5 format (20h)	12.5V	20480	5000h	overrange	$U = D \times \frac{10}{16384}$ $D = 16384 \times \frac{U}{10}$
	10V	16384	4000h	nominal range	
	5V	8192	2000h		
	0V	0	0000h		
	Not possible, is limited to 0V.				

### 4.9.3 Diagnostic data

So this module does not support diagnostic interrupt functions, the diagnostics data serve for information about this module. On error the corresponding channel LED of the module is activated and the error is registered in the diagnostics data.

The following errors are listed in the diagnostics data:

- Error in project engineering / parameterization
- Short-circuit/overload (if parameterized)

- DS Record set for access via CPU, PROFIBUS and PROFINET. The access happens by DS 01h. Additionally the first 4 bytes may be accessed by DS 00h.
- IX Index for access via CANopen. The access happens by IX 2F01h. Additionally the first 4 bytes may be accessed by IX 2F00h.
- SX Subindex for access via EtherCAT with Index 5005h.
- More can be found in the according manual of your bus coupler.

Name	Bytes	Function	Default	DS	IX	SX
ERR_A	1	Diagnostic	00h	01h	2F01h	02h
MODTYP	1	Module information	15h			03h
ERR_C	1	reserved	00h			04h
ERR_D	1	Diagnostic	00h			05h
CHTYP	1	Channel type	73h			06h
NUMBIT	1	Number diagnostic bits per channel	08h			07h
NUMCH	1	Number of channels of a module	04h			08h
CHERR	1	Channel error	00h			09h
CH0ERR	1	Channel-specific error channel 0	00h			0Ah
CH1ERR	1	Channel-specific error channel 1	00h			0Bh
CH2ERR	1	Channel-specific error channel 2	00h			0Ch
CH3ERR	1	Channel-specific error channel 3	00h			0Dh
CH4ERR... CH7ERR	4	reserved	00h			0Eh ... 11h
DIAG_US	4	µs ticker	00h			13h

**ERR\_A Diagnostic**

Byte	Bit 7 ... 0
0	<ul style="list-style-type: none"> <li>■ Bit 0: set at module failure</li> <li>■ Bit 1: set at internal error</li> <li>■ Bit 2: set at external error</li> <li>■ Bit 3: set at channel error</li> <li>■ Bit 4: set at external auxiliary supply missing</li> <li>■ Bit 6 ... 5: reserved</li> <li>■ Bit 7: set at error in parametrization</li> </ul>

**MODTYP  
Module information**

Byte	Bit 7 ... 0
0	<ul style="list-style-type: none"> <li>■ Bit 3 ... 0: module class <ul style="list-style-type: none"> <li>– 0101b analog module</li> </ul> </li> <li>■ Bit 4: set at channel information present</li> <li>■ Bit 7 ... 5: reserved</li> </ul>

032-1BD70 - AO 4x12Bit  $\pm 10V$  > Diagnostic data**ERR\_D Diagnostic**

Byte	Bit 7 ... 0
0	<ul style="list-style-type: none"> <li>■ Bit 2 ... 0: reserved</li> <li>■ Bit 3: set at internal diagnostics buffer overflow</li> <li>■ Bit 4: set at internal communication error</li> <li>■ Bit 7 ... 5: reserved</li> </ul>

**CHTYP Channel type**

Byte	Bit 7 ... 0
0	<ul style="list-style-type: none"> <li>■ Bit 6 ... 0: Channel type <ul style="list-style-type: none"> <li>- 70h: Digital input</li> <li>- 71h: Analog input</li> <li>- 72h: Digital output</li> <li>- 73h: Analog output</li> <li>- 74h: Analog input/-output</li> <li>- 76h: Counter</li> </ul> </li> <li>■ Bit 7: reserved</li> </ul>

**NUMBIT Diagnostic bits**

Byte	Bit 7 ... 0
0	Number of diagnostic bits per channel (here 08h)

**NUMCH Channels**

Byte	Bit 7 ... 0
0	Number of channels of a module (here 04h)

**CHERR Channel error**

Byte	Bit 7 ... 0
0	<ul style="list-style-type: none"> <li>■ Bit 0: set at error in channel group 0</li> <li>■ Bit 1: set at error in channel group 1</li> <li>■ Bit 2: set at error in channel group 2</li> <li>■ Bit 3: set at error in channel group 3</li> <li>■ Bit 7 ... 4: reserved</li> </ul>

**CH0ERR ... CH3ERR  
Channel-specific**

Byte	Bit 7 ... 0
0	Channel-specific error channel x: <ul style="list-style-type: none"> <li>■ Bit 0: set at configuring/parameter assignment error</li> <li>■ Bit 2 ... 1: reserved</li> <li>■ Bit 3: set at short-circuit to ground</li> <li>■ Bit 7 ... 4: reserved</li> </ul>

**CH4ERR ... CH7ERR  
reserved**

Byte	Bit 7 ... 0
0	reserved

**DIAG\_US  $\mu s$  ticker**

Byte	Bit 7 ... 0
0...3	Value of the $\mu s$ ticker at the moment of the diagnostic

 **$\mu s$  ticker**

In the System SLIO module there is a timer ( $\mu s$  ticker). With PowerON the timer starts counting with 0. After  $2^{32}-1\mu s$  the timer starts with 0 again.

032-1CB30 - AO 2x16Bit 0...10V

### 4.10 032-1CB30 - AO 2x16Bit 0...10V

#### Properties

The electronic module has 2 outputs with parameterizable functions. The channels of the module are electrically isolated from the backplane bus. In addition, the channels are isolated to the DC 24V power supply by means of DC/DC converter.

- 2 analog outputs
- Suited for sensors with 0 ... 10V
- Diagnostics function
- 16bit resolution

#### Structure

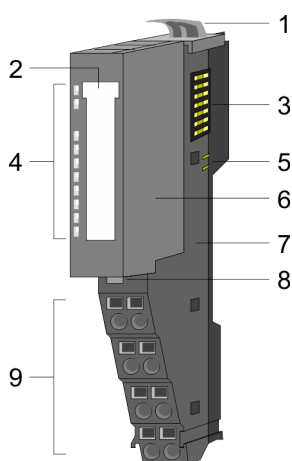

- 1 Locking lever terminal module
- 2 Labeling strip
- 3 Backplane bus
- 4 LED status indication
- 5 DC 24V power section supply
- 6 Electronic module
- 7 Terminal module
- 8 Locking lever electronic module
- 9 Terminal

#### Status indication

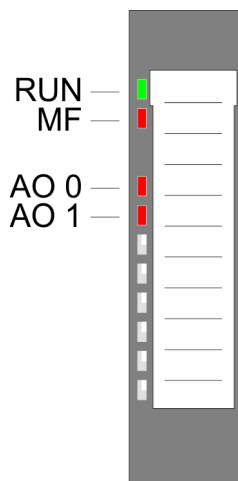

RUN	MF	AO x	Description
<input checked="" type="checkbox"/> green	<input checked="" type="checkbox"/> red	<input checked="" type="checkbox"/> red	
<input checked="" type="checkbox"/>	<input type="checkbox"/>	X	Bus communication is OK Module status is OK
<input checked="" type="checkbox"/>	<input checked="" type="checkbox"/>	X	Bus communication is OK Module status reports an error
<input type="checkbox"/>	<input checked="" type="checkbox"/>	X	Bus communication is not possible Module status reports an error
<input type="checkbox"/>	<input type="checkbox"/>	X	Error at bus power supply
X	<input checked="" type="checkbox"/>	X	Error in configuration → <a href="#">‘Trouble shooting - LEDs’...page 41</a>
<input checked="" type="checkbox"/>	<input type="checkbox"/>	<input checked="" type="checkbox"/>	Error channel x <ul style="list-style-type: none"> <li>■ Overload, short-circuit</li> <li>■ Error in parameterization</li> </ul>
not relevant: X			

**Pin assignment**

For wires with a cross section of 0.08mm<sup>2</sup> up to 1.5mm<sup>2</sup>.

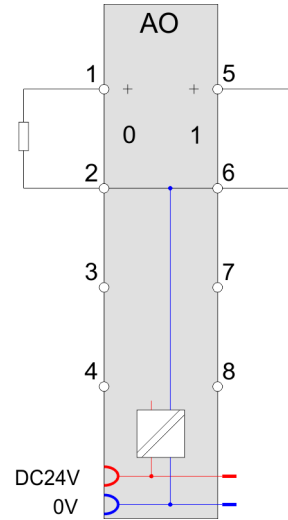
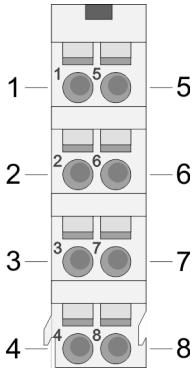

Pos.	Function	Type	Description
1	AO 0	O	Channel 0
2	AGND	O	Ground channels
3	---	---	not connected
4	---	---	not connected
5	AO 1	O	Channel 1
6	AGND	O	Ground channels
7	---	---	not connected
8	---	---	not connected

O: Output

**Input area**

No byte of the input area is used by the module.

**Output area**

At CPU, PROFIBUS and PROFINET the output area is embedded to the corresponding address area.

IX Index for access via CANopen with s = Subindex, depends on number and type of analog modules

SX Subindex for access via EtherCAT with Index 7000h + EtherCAT-Slot

More can be found in the according manual of your bus coupler.

Addr.	Name	Bytes	Function	IX	SX
+0	AO 0	2	Analog value channel 0	6411h/s	01h
+2	AO 1	2	Analog value channel 1	6411h/s+1	02h

## 4.10.1 Technical data

Order no.	032-1CB30
Type	SM 032 - Analog output
Module ID	0507 2558
<b>Current consumption/power loss</b>	
Current consumption from backplane bus	60 mA
Current consumption from load voltage L+ (without load)	20 mA
Power loss	0.8 W
<b>Technical data analog outputs</b>	
Number of outputs	2
Cable length, shielded	200 m
Rated load voltage	DC 24 V
Reverse polarity protection of rated load voltage	✓
Current consumption from rated load voltage	-
Voltage output short-circuit protection	✓
Voltage outputs	✓
Min. load resistance (voltage range)	5 kΩ
Max. capacitive load (current range)	1 μF
Max. inductive load (current range)	10 mA
Output voltage ranges	0 V ... +10 V
Operational limit of voltage ranges	+/-0.2%
Basic error limit voltage ranges	+/-0.1%
Destruction limit against external applied voltage	max. 24V
Current outputs	-
Max. in load resistance (current range)	-
Max. inductive load (current range)	-
Typ. open circuit voltage current output	-
Output current ranges	-
Operational limit of current ranges	-
Basic error limit current ranges	-
Destruction limit against external applied voltage	-
Settling time for ohmic load	150 μs
Settling time for capacitive load	1 ms
Settling time for inductive load	-
Resolution in bit	16
Conversion time	200 μs all channels
Substitute value can be applied	no
Output data size	4 Byte
<b>Status information, alarms, diagnostics</b>	



Order no.	032-1CB30
Status display	yes
Interrupts	no
Process alarm	no
Diagnostic interrupt	no
Diagnostic functions	yes
Diagnostics information read-out	possible
Supply voltage display	green LED
Group error display	red LED
Channel error display	red LED per channel
<b>Isolation</b>	
Between channels	-
Between channels of groups to	-
Between channels and backplane bus	✓
Between channels and power supply	✓
Max. potential difference between circuits	-
Max. potential difference between inputs (Ucm)	-
Max. potential difference between Mana and Mintern (Uiso)	DC 75 V/ AC 50 V
Max. potential difference between inputs and Mana (Ucm)	-
Max. potential difference between inputs and Mintern (Uiso)	-
Max. potential difference between Mintern and outputs	-
Insulation tested with	DC 500 V
<b>Datasizes</b>	
Input bytes	0
Output bytes	4
Parameter bytes	8
Diagnostic bytes	20
<b>Housing</b>	
Material	PPE / PPE GF10
Mounting	Profile rail 35 mm
<b>Mechanical data</b>	
Dimensions (WxHxD)	12.9 mm x 109 mm x 76.5 mm
Net weight	61 g
Weight including accessories	61 g
Gross weight	75 g
<b>Environmental conditions</b>	
Operating temperature	0 °C to 60 °C

032-1CB30 - AO 2x16Bit 0...10V &gt; Parameter data

<b>Order no.</b>	<b>032-1CB30</b>
Storage temperature	-25 °C to 70 °C
<b>Certifications</b>	
UL certification	yes
KC certification	yes
UKCA certification	yes
ChinaRoHS certification	yes

#### 4.10.2 Parameter data

- DS Record set for access via CPU, PROFIBUS and PROFINET  
 IX Index for access via CANopen  
 SX Subindex for access via EtherCAT with Index 3100h + EtherCAT-Slot  
 More can be found in the according manual of your bus coupler.

Name	Bytes	Function	Default	DS	IX	SX
RES0	1	reserved	00h	00h	3100h	01h
SHORT_EN	1	Short-circuit recognition	00h	00h	3101h	02h
CH0FN	1	Function number channel 0	10h	80h	3102h	03h
CH1FN	1	Function number channel 1	10h	81h	3103h	04h

#### SHORT\_EN Short-circuit recognition

Byte	Bit 7 ... 0
0	<ul style="list-style-type: none"> <li>■ Bit 0: Short-circuit recognition channel 0 (1:on)</li> <li>■ Bit 1: Short-circuit recognition channel 1 (1:on)</li> <li>■ Bit 7 ... 2: reserved</li> </ul>

#### CHxFN Function number channel x

In the following there are the measuring ranges with corresponding function number listed, which were supported by the analog module. With FFh the corresponding channel is deactivated.

The formulas listed here allow you to transform an evaluated measuring value (digital value) to a value assigned to the measuring range (analog value) and vice versa.

Output range voltage 0 ... 10V (funct. no.)	Voltage (U)	Decimal (D)	Hex	Range	Formulas
0 ... 10V Siemens S7 format (10h)	11.76V	32511	7EFFh	overrange	$U = D \times \frac{10}{27648}$ $D = 27648 \times \frac{U}{10}$
	10V	27648	6C00h	nominal range	
	5V	13824	3600h		
	0V	0	0000h		
	Not possible, is limited to 0V.				
0 ... 10V Siemens S5 format (20h)	12.5V	20480	5000h	overrange	$U = D \times \frac{10}{16384}$ $D = 16384 \times \frac{U}{10}$
	10V	16384	4000h	nominal range	
	5V	8192	2000h		
	0V	0	0000h		
	Not possible, is limited to 0V.				

### 4.10.3 Diagnostic data

So this module does not support diagnostic interrupt functions, the diagnostics data serve for information about this module. On error the corresponding channel LED of the module is activated and the error is registered in the diagnostics data.

The following errors are listed in the diagnostics data:

- Error in project engineering / parameterization
- Short-circuit/overload (if parameterized)

DS Record set for access via CPU, PROFIBUS and PROFINET. The access happens by DS 01h. Additionally the first 4 bytes may be accessed by DS 00h.

IX Index for access via CANopen. The access happens by IX 2F01h. Additionally the first 4 bytes may be accessed by IX 2F00h.

SX Subindex for access via EtherCAT with Index 5005h.

More can be found in the according manual of your bus coupler.

032-1CB30 - AO 2x16Bit 0...10V &gt; Diagnostic data

Name	Bytes	Function	Default	DS	IX	SX
ERR_A	1	Diagnostic	00h	01h	2F01h	02h
MODTYP	1	Module information	15h			03h
ERR_C	1	reserved	00h			04h
ERR_D	1	Diagnostic	00h			05h
CHTYP	1	Channel type	73h			06h
NUMBIT	1	Number diagnostic bits per channel	08h			07h
NUMCH	1	Number of channels of a module	02h			08h
CHERR	1	Channel error	00h			09h
CH0ERR	1	Channel-specific error channel 0	00h			0Ah
CH1ERR	1	Channel-specific error channel 1	00h			0Bh
CH2ERR... CH7ERR	6	reserved	00h			0Ch ... 11h
DIAG_US	4	µs ticker	00h			13h

**ERR\_A Diagnostic**

Byte	Bit 7 ... 0
0	<ul style="list-style-type: none"> <li>■ Bit 0: set at module failure</li> <li>■ Bit 1: set at internal error</li> <li>■ Bit 2: set at external error</li> <li>■ Bit 3: set at channel error</li> <li>■ Bit 4: set at external auxiliary supply missing</li> <li>■ Bit 6 ... 5: reserved</li> <li>■ Bit 7: set at error in parametrization</li> </ul>

**MODTYP**  
*Module information*

Byte	Bit 7 ... 0
0	<ul style="list-style-type: none"> <li>■ Bit 3 ... 0: module class <ul style="list-style-type: none"> <li>– 0101b analog module</li> </ul> </li> <li>■ Bit 4: set at channel information present</li> <li>■ Bit 7 ... 5: reserved</li> </ul>

**ERR\_D Diagnostic**

Byte	Bit 7 ... 0
0	<ul style="list-style-type: none"> <li>■ Bit 2 ... 0: reserved</li> <li>■ Bit 3: set at internal diagnostics buffer overflow</li> <li>■ Bit 4: set at internal communication error</li> <li>■ Bit 7 ... 5: reserved</li> </ul>

**CHTYP Channel type**

Byte	Bit 7 ... 0
0	<ul style="list-style-type: none"> <li>■ Bit 6 ... 0: Channel type               <ul style="list-style-type: none"> <li>- 70h: Digital input</li> <li>- 71h: Analog input</li> <li>- 72h: Digital output</li> <li>- 73h: Analog output</li> <li>- 74h: Analog input/-output</li> <li>- 76h: Counter</li> </ul> </li> <li>■ Bit 7: reserved</li> </ul>

**NUMBIT Diagnostic bits**

Byte	Bit 7 ... 0
0	Number of diagnostic bits per channel (here 08h)

**NUMCH Channels**

Byte	Bit 7 ... 0
0	Number of channels of a module (here 02h)

**CHERR Channel error**

Byte	Bit 7 ... 0
0	<ul style="list-style-type: none"> <li>■ Bit 0: set at error in channel group 0</li> <li>■ Bit 1: set at error in channel group 1</li> <li>■ Bit 7 ... 2: reserved</li> </ul>

**CH0ERR / CH1ERR  
Channel specific**

Byte	Bit 7 ... 0
0	Channel-specific error channel x: <ul style="list-style-type: none"> <li>■ Bit 0: set at configuring/parameter assignment error</li> <li>■ Bit 2 ... 1: reserved</li> <li>■ Bit 3: set at short-circuit to ground</li> <li>■ Bit 7 ... 4: reserved</li> </ul>

**CH2ERR ... CH7ERR  
reserved**

Byte	Bit 7 ... 0
0	reserved

**DIAG\_US  $\mu$ s ticker**

Byte	Bit 7 ... 0
0...3	Value of the $\mu$ s ticker at the moment of the diagnostic

 **$\mu$ s ticker**

In the System SLIO module there is a timer ( $\mu$ s ticker). With PowerON the timer starts counting with 0. After  $2^{32}-1\mu$ s the timer starts with 0 again.

032-1CB40 - AO 2x16Bit 0(4)...20mA

### 4.11 032-1CB40 - AO 2x16Bit 0(4)...20mA

#### Properties

The electronic module has 2 outputs with parameterizable functions. The channels of the module are electrically isolated from the backplane bus. In addition, the channels are isolated to the DC 24V power supply by means of DC/DC converter.

- 2 analog outputs
- Suited for sensors with 0 ... 20mA; 4 ... 20mA
- Diagnostics function
- 16bit resolution

#### Structure

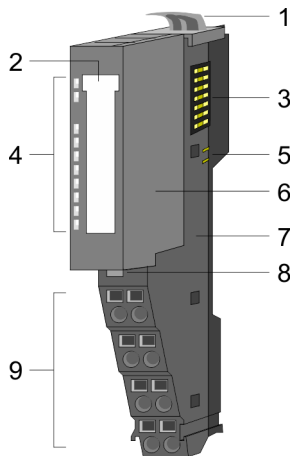

- 1 Locking lever terminal module
- 2 Labeling strip
- 3 Backplane bus
- 4 LED status indication
- 5 DC 24V power section supply
- 6 Electronic module
- 7 Terminal module
- 8 Locking lever electronic module
- 9 Terminal

#### Status indication

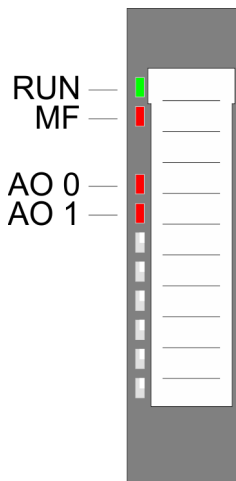

RUN	MF	AO x	Description
<input checked="" type="checkbox"/> green	<input checked="" type="checkbox"/> red	<input checked="" type="checkbox"/> red	
<input checked="" type="checkbox"/>	<input type="checkbox"/>	X	Bus communication is OK Module status is OK
<input checked="" type="checkbox"/>	<input checked="" type="checkbox"/>	X	Bus communication is OK Module status reports an error
<input type="checkbox"/>	<input checked="" type="checkbox"/>	X	Bus communication is not possible Module status reports an error
<input type="checkbox"/>	<input type="checkbox"/>	X	Error at bus power supply
X	<input checked="" type="checkbox"/>	X	Error in configuration → <a href="#">‘Trouble shooting - LEDs’...page 41</a>
<input checked="" type="checkbox"/>	<input type="checkbox"/>	<input checked="" type="checkbox"/>	Error channel x <ul style="list-style-type: none"> <li>■ Error in parameterization</li> <li>■ Wire break (if parameterized)</li> </ul>
not relevant: X			

**Pin assignment**

For wires with a cross section of 0.08mm<sup>2</sup> up to 1.5mm<sup>2</sup>.

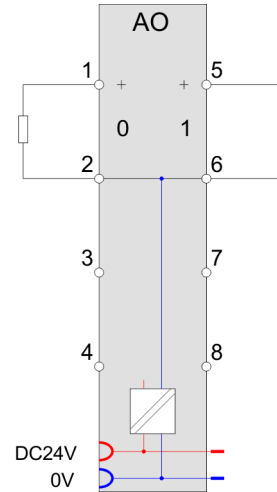
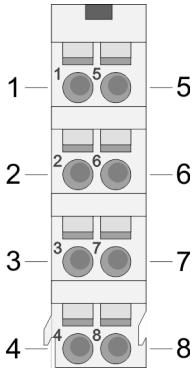

Pos.	Function	Type	Description
1	AO 0	O	Channel 0
2	AGND	O	Ground channels
3	---	---	not connected
4	---	---	not connected
5	AO 1	O	Channel 1
6	AGND	O	Ground channels
7	---	---	not connected
8	---	---	not connected

O: Output

**Input area**

No byte of the input area is used by the module.

**Output area**

At CPU, PROFIBUS and PROFINET the output area is embedded to the corresponding address area.

IX Index for access via CANopen with s = Subindex, depends on number and type of analog modules

SX Subindex for access via EtherCAT with Index 7000h + EtherCAT-Slot

More can be found in the according manual of your bus coupler.

Addr.	Name	Bytes	Function	IX	SX
+0	AO 0	2	Analog value channel 0	6411h/s	01h
+2	AO 1	2	Analog value channel 1	6411h/s+1	02h

## 4.11.1 Technical data

Order no.	032-1CB40
Type	SM 032 - Analog output
Module ID	050B 25D8
<b>Current consumption/power loss</b>	
Current consumption from backplane bus	60 mA
Current consumption from load voltage L+ (without load)	15 mA
Power loss	0.7 W
<b>Technical data analog outputs</b>	
Number of outputs	2
Cable length, shielded	200 m
Rated load voltage	DC 24 V
Reverse polarity protection of rated load voltage	✓
Current consumption from rated load voltage	-
Voltage output short-circuit protection	-
Voltage outputs	-
Min. load resistance (voltage range)	-
Max. capacitive load (current range)	-
Max. inductive load (current range)	-
Output voltage ranges	-
Operational limit of voltage ranges	-
Basic error limit voltage ranges	-
Destruction limit against external applied voltage	-
Current outputs	✓
Max. in load resistance (current range)	350 Ω
Max. inductive load (current range)	10 mH
Typ. open circuit voltage current output	12 V
Output current ranges	0 mA ... +20 mA +4 mA ... +20 mA
Operational limit of current ranges	+/-0.2%
Basic error limit current ranges	+/-0.1%
Destruction limit against external applied voltage	max. 12V (30V for 1s)
Settling time for ohmic load	0.25 ms
Settling time for capacitive load	-
Settling time for inductive load	1.5 ms
Resolution in bit	16
Conversion time	400 μs all channels
Substitute value can be applied	no
Output data size	4 Byte



Order no.	032-1CB40
<b>Status information, alarms, diagnostics</b>	
Status display	yes
Interrupts	no
Process alarm	no
Diagnostic interrupt	no
Diagnostic functions	yes
Diagnostics information read-out	possible
Supply voltage display	green LED
Group error display	red LED
Channel error display	red LED per channel
<b>Isolation</b>	
Between channels	-
Between channels of groups to	-
Between channels and backplane bus	✓
Between channels and power supply	✓
Max. potential difference between circuits	-
Max. potential difference between inputs (Ucm)	-
Max. potential difference between Mana and Mintern (Uiso)	DC 75 V/ AC 50 V
Max. potential difference between inputs and Mana (Ucm)	-
Max. potential difference between inputs and Mintern (Uiso)	-
Max. potential difference between Mintern and outputs	-
Insulation tested with	DC 500 V
<b>Datasizes</b>	
Input bytes	0
Output bytes	4
Parameter bytes	8
Diagnostic bytes	20
<b>Housing</b>	
Material	PPE / PPE GF10
Mounting	Profile rail 35 mm
<b>Mechanical data</b>	
Dimensions (WxHxD)	12.9 mm x 109 mm x 76.5 mm
Net weight	61 g
Weight including accessories	61 g
Gross weight	75 g
<b>Environmental conditions</b>	

032-1CB40 - AO 2x16Bit 0(4)...20mA &gt; Parameter data

<b>Order no.</b>	<b>032-1CB40</b>
Operating temperature	0 °C to 60 °C
Storage temperature	-25 °C to 70 °C
<b>Certifications</b>	
UL certification	yes
KC certification	yes
UKCA certification	yes
ChinaRoHS certification	yes

#### 4.11.2 Parameter data

- DS Record set for access via CPU, PROFIBUS and PROFINET  
 IX Index for access via CANopen  
 SX Subindex for access via EtherCAT with Index 3100h + EtherCAT-Slot  
 More can be found in the according manual of your bus coupler.

Name	Bytes	Function	Default	DS	IX	SX
RES0	1	reserved	00h	00h	3100h	01h
WIBRK_EN	1	Wire-break recognition	00h	00h	3101h	02h
CH0FN	1	Function number channel 0	31h	80h	3102h	03h
CH1FN	1	Function number channel 1	31h	81h	3103h	04h

#### WIBRK\_EN Wire-break recognition

Byte	Bit 7 ... 0
0	<ul style="list-style-type: none"> <li>■ Bit 0: Wire-break recognition channel 0 (1: on)</li> <li>■ Bit 1: Wire-break recognition channel 1 (1: on)</li> <li>■ Bit 7 ... 2: reserved</li> </ul>



*Please consider with enabled wire break recognition with the output range 0 ... 20mA, when the current goes below of 40µA (100 Digits), this can may lead to sporadic wire break messages!*

#### CHxFN Function number channel x

In the following there are the measuring ranges with corresponding function number listed, which were supported by the analog module. With FFh the corresponding channel is deactivated. The formulas listed here allow you to transform an evaluated measuring value (digital value) to a value assigned to the measuring range (analog value) and vice versa.

Output range current 0 ... 20mA (funct. no.)	Current (I)	Decimal (D)	Hex	Range	Formulas
0 ... 20mA Siemens S7 format (31h)	23.52mA	32511	7EFFh	overrange	$I = D \times \frac{20}{27648}$ $D = 27648 \times \frac{I}{20}$
	20mA	27648	6C00h	nominal range	
	10mA	13824	3600h		
	0mA	0	0000h		
	Not possible, is limited to 0mA.			underrange	
0 ... 20mA Siemens S5 format (41h)	25.00mA	20480	5000h	overrange	$I = D \times \frac{20}{16384}$ $D = 16384 \times \frac{I}{20}$
	20mA	16384	4000h	nominal range	
	10mA	8192	2000h		
	0mA	0	0000h		
	Not possible, is limited to 0mA.			underrange	

Output range current 4 ... 20mA (funct. no.)	Current (I)	Decimal (D)	Hex	Range	Formulas
4 ... 20mA Siemens S7 format (30h)	22.81mA	32511	7EFFh	overrange	$I = D \times \frac{16}{27648} + 4$ $D = 27648 \times \frac{I-4}{16}$
	20mA	27648	6C00h	nominal range	
	12mA	13824	3600h		
	4mA	0	0000h		
	0mA	-6912	E500h	underrange	
4 ... 20mA Siemens S5 format (40h)	24.00mA	20480	5000h	overrange	$I = D \times \frac{16}{16384} + 4$ $D = 16384 \times \frac{I-4}{16}$
	20mA	16384	4000h	nominal range	
	12mA	8192	2000h		
	4mA	0	0000h		
	0mA	-4096	F000h	underrange	

### 4.11.3 Diagnostic data

So this module does not support diagnostic interrupt functions, the diagnostics data serve for information about this module. On error the corresponding channel LED of the module is activated and the error is registered in the diagnostics data.

The following errors are listed in the diagnostics data:

- Error in project engineering / parameterization
- Wire-break (if parameterized)

032-1CB40 - AO 2x16Bit 0(4)...20mA &gt; Diagnostic data

- DS Record set for access via CPU, PROFIBUS and PROFINET. The access happens by DS 01h. Additionally the first 4 bytes may be accessed by DS 00h.
- IX Index for access via CANopen. The access happens by IX 2F01h. Additionally the first 4 bytes may be accessed by IX 2F00h.
- SX Subindex for access via EtherCAT with Index 5005h.
- More can be found in the according manual of your bus coupler.

Name	Bytes	Function	Default	DS	IX	SX
ERR_A	1	Diagnostic	00h	01h	2F01h	02h
MODTYP	1	Module information	15h			03h
ERR_C	1	reserved	00h			04h
ERR_D	1	Diagnostic	00h			05h
CHTYP	1	Channel type	73h			06h
NUMBIT	1	Number diagnostic bits per channel	08h			07h
NUMCH	1	Number of channels of a module	02h			08h
CHERR	1	Channel error	00h			09h
CH0ERR	1	Channel-specific error channel 0	00h			0Ah
CH1ERR	1	Channel-specific error channel 1	00h			0Bh
CH2ERR... CH7ERR	6	reserved	00h			0Ch ... 11h
DIAG_US	4	µs ticker	00h			13h

**ERR\_A Diagnostic**

Byte	Bit 7 ... 0
0	<ul style="list-style-type: none"> <li>■ Bit 0: set at module failure</li> <li>■ Bit 1: set at internal error</li> <li>■ Bit 2: set at external error</li> <li>■ Bit 3: set at channel error</li> <li>■ Bit 4: set at external auxiliary supply missing</li> <li>■ Bit 6 ... 5: reserved</li> <li>■ Bit 7: set at error in parametrization</li> </ul>

**MODTYP  
Module information**

Byte	Bit 7 ... 0
0	<ul style="list-style-type: none"> <li>■ Bit 3 ... 0: module class <ul style="list-style-type: none"> <li>- 0101b analog module</li> </ul> </li> <li>■ Bit 4: set at channel information present</li> <li>■ Bit 7 ... 5: reserved</li> </ul>

**ERR\_D Diagnostic**

Byte	Bit 7 ... 0
0	<ul style="list-style-type: none"> <li>■ Bit 2 ... 0: reserved</li> <li>■ Bit 3: set at internal diagnostics buffer overflow</li> <li>■ Bit 4: set at internal communication error</li> <li>■ Bit 7 ... 5: reserved</li> </ul>

**CHTYP Channel type**

Byte	Bit 7 ... 0
0	<ul style="list-style-type: none"> <li>■ Bit 6 ... 0: Channel type <ul style="list-style-type: none"> <li>- 70h: Digital input</li> <li>- 71h: Analog input</li> <li>- 72h: Digital output</li> <li>- 73h: Analog output</li> <li>- 74h: Analog input/-output</li> <li>- 76h: Counter</li> </ul> </li> <li>■ Bit 7: reserved</li> </ul>

**NUMBIT Diagnostic bits**

Byte	Bit 7 ... 0
0	Number of diagnostic bits per channel (here 08h)

**NUMCH Channels**

Byte	Bit 7 ... 0
0	Number of channels of a module (here 02h)

**CHERR Channel error**

Byte	Bit 7 ... 0
0	<ul style="list-style-type: none"> <li>■ Bit 0: set at error in channel group 0</li> <li>■ Bit 1: set at error in channel group 1</li> <li>■ Bit 7 ... 2: reserved</li> </ul>

**CH0ERR / CH1ERR  
Channel-specific**

Byte	Bit 7 ... 0
0	Channel-specific error channel x <ul style="list-style-type: none"> <li>■ Bit 0: set at configuring/parameter assignment error</li> <li>■ Bit 3 ... 1: reserved</li> <li>■ Bit 4: set at wire-break</li> <li>■ Bit 7 ... 5: reserved</li> </ul>

**CH2ERR ... CH7ERR  
reserved**

Byte	Bit 7 ... 0
0	reserved

032-1CB40 - AO 2x16Bit 0(4)...20mA > Diagnostic data

**DIAG\_US  $\mu$ s ticker**

Byte	Bit 7 ... 0
0...3	Value of the $\mu$ s ticker at the moment of the diagnostic

 *$\mu$ s ticker*

In the System SLIO module there is a timer ( $\mu$ s ticker). With PowerON the timer starts counting with 0. After  $2^{32}-1\mu$ s the timer starts with 0 again.

### 4.12 032-1CB70 - AO 2x16Bit ±10V

**Properties**

The electronic module has 2 outputs with parameterizable functions. The channels of the module are electrically isolated from the backplane bus. In addition, the channels are isolated to the DC 24V power supply by means of DC/DC converter.

- 2 analog outputs
- Suited for sensors with ±10V, 0 ... 10V
- Diagnostics function
- 16bit resolution

**Structure**

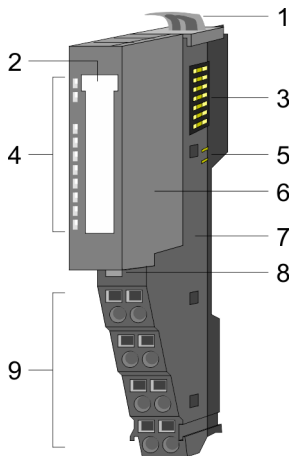

- 1 Locking lever terminal module
- 2 Labeling strip
- 3 Backplane bus
- 4 LED status indication
- 5 DC 24V power section supply
- 6 Electronic module
- 7 Terminal module
- 8 Locking lever electronic module
- 9 Terminal

**Status indication**

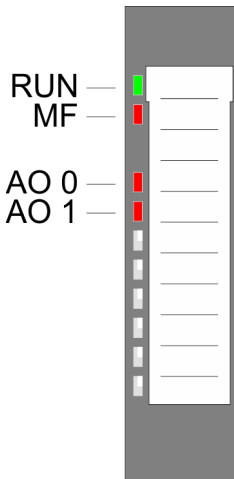

RUN	MF	AO x	Description
<input checked="" type="checkbox"/> green	<input checked="" type="checkbox"/> red	<input checked="" type="checkbox"/> red	
<input checked="" type="checkbox"/>	<input type="checkbox"/>	X	Bus communication is OK Module status is OK
<input checked="" type="checkbox"/>	<input checked="" type="checkbox"/>	X	Bus communication is OK Module status reports an error
<input type="checkbox"/>	<input checked="" type="checkbox"/>	X	Bus communication is not possible Module status reports an error
<input type="checkbox"/>	<input type="checkbox"/>	X	Error at bus power supply
X	<input checked="" type="checkbox"/>	X	Error in configuration → <a href="#">‘Trouble shooting - LEDs’...page 41</a>
<input checked="" type="checkbox"/>	<input type="checkbox"/>	<input checked="" type="checkbox"/>	Error channel x <ul style="list-style-type: none"> <li>■ Overload, short-circuit</li> <li>■ Error in parameterization</li> </ul>
not relevant: X			

032-1CB70 - AO 2x16Bit ±10V

**Pin assignment**

For wires with a cross section of 0.08mm<sup>2</sup> up to 1.5mm<sup>2</sup>.

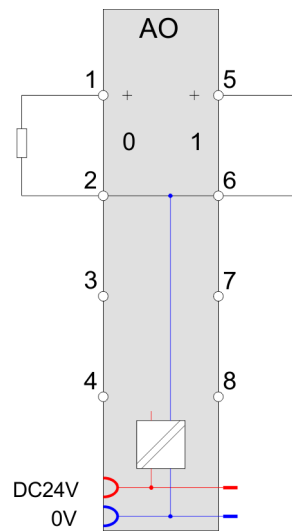
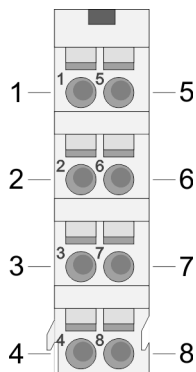

Pos.	Function	Type	Description
1	AO 0	O	Channel 0
2	AGND	O	Ground channels
3	---	---	not connected
4	---	---	not connected
5	AO 1	O	Channel 1
6	AGND	O	Ground channels
7	---	---	not connected
8	---	---	not connected

O: Output

**Input area**

No byte of the input area is used by the module.

**Output area**

At CPU, PROFIBUS and PROFINET the output area is embedded to the corresponding address area.

IX Index for access via CANopen with s = Subindex, depends on number and type of analog modules

SX Subindex for access via EtherCAT with Index 7000h + EtherCAT-Slot

More can be found in the according manual of your bus coupler.

Addr.	Name	Bytes	Function	IX	SX
+0	AO 0	2	Analog value channel 0	6411h/s	01h
+2	AO 1	2	Analog value channel 1	6411h/s+1	02h



## 4.12.1 Technical data

Order no.	032-1CB70
Type	SM 032 - Analog output
Module ID	0508 2558
<b>Current consumption/power loss</b>	
Current consumption from backplane bus	60 mA
Current consumption from load voltage L+ (without load)	20 mA
Power loss	0.8 W
<b>Technical data analog outputs</b>	
Number of outputs	2
Cable length, shielded	200 m
Rated load voltage	DC 24 V
Reverse polarity protection of rated load voltage	✓
Current consumption from rated load voltage	-
Voltage output short-circuit protection	✓
Voltage outputs	✓
Min. load resistance (voltage range)	5 k $\Omega$
Max. capacitive load (current range)	1 $\mu$ F
Max. inductive load (current range)	10 mA
Output voltage ranges	-10 V ... +10 V 0 V ... +10 V
Operational limit of voltage ranges	+/-0.2%
Basic error limit voltage ranges	+/-0.1%
Destruction limit against external applied voltage	max. 24V
Current outputs	-
Max. in load resistance (current range)	-
Max. inductive load (current range)	-
Typ. open circuit voltage current output	-
Output current ranges	-
Operational limit of current ranges	-
Basic error limit current ranges	-
Destruction limit against external applied voltage	-
Settling time for ohmic load	300 $\mu$ s
Settling time for capacitive load	3 ms
Settling time for inductive load	-
Resolution in bit	16
Conversion time	200 $\mu$ s all channels
Substitute value can be applied	no
Output data size	4 Byte

032-1CB70 - AO 2x16Bit  $\pm 10V$  > Technical data

Order no.	032-1CB70
<b>Status information, alarms, diagnostics</b>	
Status display	yes
Interrupts	no
Process alarm	no
Diagnostic interrupt	no
Diagnostic functions	yes
Diagnostics information read-out	possible
Supply voltage display	green LED
Group error display	red LED
Channel error display	red LED per channel
<b>Isolation</b>	
Between channels	-
Between channels of groups to	-
Between channels and backplane bus	✓
Between channels and power supply	✓
Max. potential difference between circuits	-
Max. potential difference between inputs (Ucm)	-
Max. potential difference between Mana and Mintern (Uiso)	DC 75 V/ AC 50 V
Max. potential difference between inputs and Mana (Ucm)	-
Max. potential difference between inputs and Mintern (Uiso)	-
Max. potential difference between Mintern and outputs	-
Insulation tested with	DC 500 V
<b>Datasizes</b>	
Input bytes	0
Output bytes	4
Parameter bytes	8
Diagnostic bytes	20
<b>Housing</b>	
Material	PPE / PPE GF10
Mounting	Profile rail 35 mm
<b>Mechanical data</b>	
Dimensions (WxHxD)	12.9 mm x 109 mm x 76.5 mm
Net weight	60 g
Weight including accessories	60 g
Gross weight	75 g
<b>Environmental conditions</b>	

<b>Order no.</b>	<b>032-1CB70</b>
Operating temperature	0 °C to 60 °C
Storage temperature	-25 °C to 70 °C
<b>Certifications</b>	
UL certification	yes
KC certification	yes
UKCA certification	yes
ChinaRoHS certification	yes

#### 4.12.2 Parameter data

- DS Record set for access via CPU, PROFIBUS and PROFINET  
 IX Index for access via CANopen  
 SX Subindex for access via EtherCAT with Index 3100h + EtherCAT-Slot  
 More can be found in the according manual of your bus coupler.

Name	Bytes	Function	Default	DS	IX	SX
RES0	1	reserved	00h	00h	3100h	01h
SHORT_EN	1	Short-circuit recognition	00h	00h	3101h	02h
CH0FN	1	Function number channel 0	12h	80h	3102h	03h
CH1FN	1	Function number channel 1	12h	81h	3103h	04h

#### SHORT\_EN Short-circuit recognition

Byte	Bit 7 ... 0
0	<ul style="list-style-type: none"> <li>■ Bit 0: Short-circuit recognition channel 0 (1:on)</li> <li>■ Bit 1: Short-circuit recognition channel 1 (1:on)</li> <li>■ Bit 7 ... 2: reserved</li> </ul>

#### CHxFN Function number channel x

In the following there are the measuring ranges with corresponding function number listed, which were supported by the analog module. With FFh the corresponding channel is deactivated. The formulas listed here allow you to transform an evaluated measuring value (digital value) to a value assigned to the measuring range (analog value) and vice versa.

032-1CB70 - AO 2x16Bit ±10V &gt; Diagnostic data

Output range voltage ±10V (funct. no.)	Voltage (U)	Decimal (D)	Hex	Range	Formulas
±10V Siemens S7 format (12h)	11.76V	32511	7EFFh	overrange	$U = D \times \frac{10}{27648}$ $D = 27648 \times \frac{U}{10}$
	10V	27648	6C00h	nominal range	
	5V	13824	3600h		
	0V	0	0000h		
	-5V	-13824	CA00h		
	-10V	-27648	9400h		
	-11.76V	-32512	8100h	underrange	
±10V Siemens S5 format (22h)	12.5V	20480	5000h	overrange	$U = D \times \frac{10}{16384}$ $D = 16384 \times \frac{U}{10}$
	10V	16384	4000h	nominal range	
	5V	8192	2000h		
	0V	0	0000h		
	-5V	-8192	E000h		
	-10V	-16384	C000h		
	-12.5V	-20480	B000h	underrange	

Output range voltage 0 ... 10V (funct. no.)	Voltage (U)	Decimal (D)	Hex	Range	Formulas
0 ... 10V Siemens S7 format (10h)	11.76V	32511	7EFFh	overrange	$U = D \times \frac{10}{27648}$ $D = 27648 \times \frac{U}{10}$
	10V	27648	6C00h	nominal range	
	5V	13824	3600h		
	0V	0	0000h		
	Not possible, is limited to 0V.			underrange	
0 ... 10V Siemens S5 format (20h)	12.5V	20480	5000h	overrange	$U = D \times \frac{10}{16384}$ $D = 16384 \times \frac{U}{10}$
	10V	16384	4000h	nominal range	
	5V	8192	2000h		
	0V	0	0000h		
	Not possible, is limited to 0V.			underrange	

### 4.12.3 Diagnostic data

So this module does not support diagnostic interrupt functions, the diagnostics data serve for information about this module. On error the corresponding channel LED of the module is activated and the error is registered in the diagnostics data.

The following errors are listed in the diagnostics data:

- Error in project engineering / parameterization
- Short-circuit/overload (if parameterized)

- DS Record set for access via CPU, PROFIBUS and PROFINET. The access happens by DS 01h. Additionally the first 4 bytes may be accessed by DS 00h.
- IX Index for access via CANopen. The access happens by IX 2F01h. Additionally the first 4 bytes may be accessed by IX 2F00h.
- SX Subindex for access via EtherCAT with Index 5005h.
- More can be found in the according manual of your bus coupler.

Name	Bytes	Function	Default	DS	IX	SX
ERR_A	1	Diagnostic	00h	01h	2F01h	02h
MODTYP	1	Module information	15h			03h
ERR_C	1	reserved	00h			04h
ERR_D	1	Diagnostic	00h			05h
CHTYP	1	Channel type	73h			06h
NUMBIT	1	Number diagnostic bits per channel	08h			07h
NUMCH	1	Number of channels of a module	02h			08h
CHERR	1	Channel error	00h			09h
CH0ERR	1	Channel-specific error channel 0	00h			0Ah
CH1ERR	1	Channel-specific error channel 1	00h			0Bh
CH2ERR... CH7ERR	6	reserved	00h			0Ch ... 11h
DIAG_US	4	µs ticker	00h			13h

**ERR\_A Diagnostic**

Byte	Bit 7 ... 0
0	<ul style="list-style-type: none"> <li>■ Bit 0: set at module failure</li> <li>■ Bit 1: set at internal error</li> <li>■ Bit 2: set at external error</li> <li>■ Bit 3: set at channel error</li> <li>■ Bit 4: set at external auxiliary supply missing</li> <li>■ Bit 6 ... 5: reserved</li> <li>■ Bit 7: set at error in parametrization</li> </ul>

**MODTYP  
Module information**

Byte	Bit 7 ... 0
0	<ul style="list-style-type: none"> <li>■ Bit 3 ... 0: module class <ul style="list-style-type: none"> <li>- 0101b analog module</li> </ul> </li> <li>■ Bit 4: set at channel information present</li> <li>■ Bit 7 ... 5: reserved</li> </ul>

032-1CB70 - AO 2x16Bit ±10V &gt; Diagnostic data

**ERR\_D Diagnostic**

Byte	Bit 7 ... 0
0	<ul style="list-style-type: none"> <li>■ Bit 2 ... 0: reserved</li> <li>■ Bit 3: set at internal diagnostics buffer overflow</li> <li>■ Bit 4: set at internal communication error</li> <li>■ Bit 7 ... 5: reserved</li> </ul>

**CHTYP Channel type**

Byte	Bit 7 ... 0
0	<ul style="list-style-type: none"> <li>■ Bit 6 ... 0: Channel type <ul style="list-style-type: none"> <li>- 70h: Digital input</li> <li>- 71h: Analog input</li> <li>- 72h: Digital output</li> <li>- 73h: Analog output</li> <li>- 74h: Analog input/-output</li> <li>- 76h: Counter</li> </ul> </li> <li>■ Bit 7: reserved</li> </ul>

**NUMBIT Diagnostic bits**

Byte	Bit 7 ... 0
0	Number of diagnostic bits per channel (here 08h)

**NUMCH Channels**

Byte	Bit 7 ... 0
0	Number of channels of a module (here 02h)

**CHERR Channel error**

Byte	Bit 7 ... 0
0	<ul style="list-style-type: none"> <li>■ Bit 0: set at error in channel group 0</li> <li>■ Bit 1: set at error in channel group 1</li> <li>■ Bit 7 ... 2: reserved</li> </ul>

**CH0ERR / CH1ERR  
Channel-specific**

Byte	Bit 7 ... 0
0	Channel-specific error channel x: <ul style="list-style-type: none"> <li>■ Bit 0: set at configuring/parameter assignment error</li> <li>■ Bit 2 ... 1: reserved</li> <li>■ Bit 3: set at short-circuit to ground</li> <li>■ Bit 7 ... 4: reserved</li> </ul>

**CH2ERR ... CH7ERR  
reserved**

Byte	Bit 7 ... 0
0	reserved

**DIAG\_US  $\mu s$  ticker**

Byte	Bit 7 ... 0
0...3	Value of the $\mu s$ ticker at the moment of the diagnostic

 **$\mu s$  ticker**

In the System SLIO module there is a timer ( $\mu s$  ticker). With PowerON the timer starts counting with 0. After  $2^{32}-1\mu s$  the timer starts with 0 again.

032-1CD30 - AO 4x16Bit 0...10V

### 4.13 032-1CD30 - AO 4x16Bit 0...10V

#### Properties

The electronic module has 4 outputs with parameterizable functions. The channels of the module are electrically isolated from the backplane bus. In addition, the channels are isolated to the DC 24V power supply by means of DC/DC converter.

- 4 analog outputs
- Suited for sensors with 0 ... 10V
- Diagnostics function
- 16bit resolution

#### Structure

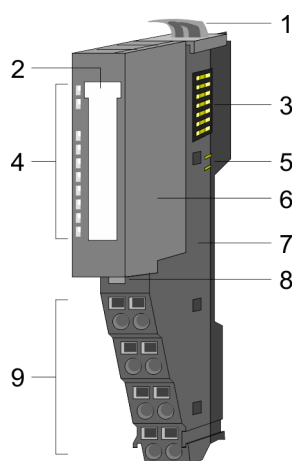

- 1 Locking lever terminal module
- 2 Labeling strip
- 3 Backplane bus
- 4 LED status indication
- 5 DC 24V power section supply
- 6 Electronic module
- 7 Terminal module
- 8 Locking lever electronic module
- 9 Terminal

#### Status indication

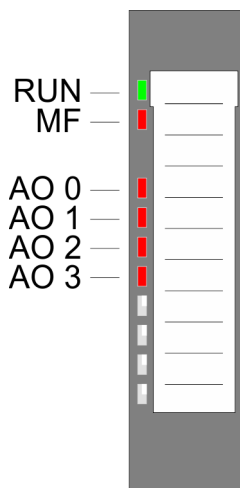

RUN	MF	AO x	Description
<input checked="" type="checkbox"/> green	<input checked="" type="checkbox"/> red	<input checked="" type="checkbox"/> red	
<input checked="" type="checkbox"/>	<input type="checkbox"/>	X	Bus communication is OK Module status is OK
<input checked="" type="checkbox"/>	<input checked="" type="checkbox"/>	X	Bus communication is OK Module status reports an error
<input type="checkbox"/>	<input checked="" type="checkbox"/>	X	Bus communication is not possible Module status reports an error
<input type="checkbox"/>	<input type="checkbox"/>	X	Error at bus power supply
X	<input checked="" type="checkbox"/>	X	Error in configuration → <a href="#">‘Trouble shooting - LEDs’...page 41</a>
<input checked="" type="checkbox"/>	<input type="checkbox"/>	<input checked="" type="checkbox"/>	Error channel x <ul style="list-style-type: none"> <li>■ Overload, short-circuit</li> <li>■ Error in parameterization</li> </ul>
not relevant: X			



**Pin assignment**

For wires with a cross section of 0.08mm<sup>2</sup> up to 1.5mm<sup>2</sup>.

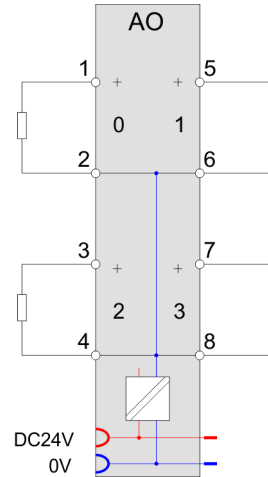
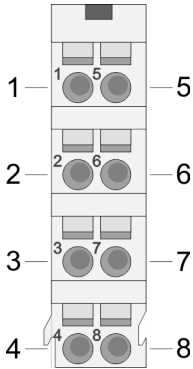

Pos.	Function	Type	Description
1	AO 0	O	Channel 0
2	AGND	O	Ground channels
3	AO 2	O	Channel 2
4	AGND	O	Ground channels
5	AO 1	O	Channel 1
6	AGND	O	Ground channels
7	AO 3	O	Channel 3
8	AGND	O	Ground channels

O: Output

**Input area**

No byte of the input area is used by the module.

**Output area**

At CPU, PROFIBUS and PROFINET the output area is embedded to the corresponding address area.

IX Index for access via CANopen with s = Subindex, depends on number and type of analog modules

SX Subindex for access via EtherCAT with Index 7000h + EtherCAT-Slot

More can be found in the according manual of your bus coupler.

Addr.	Name	Bytes	Function	IX	SX
+0	AO 0	2	Analog value channel 0	6411h/s	01h
+2	AO 1	2	Analog value channel 1	6411h/s+1	02h
+4	AO 2	2	Analog value channel 2	6411h/s+2	03h
+6	AO 3	2	Analog value channel 3	6411h/s+3	04h

## 4.13.1 Technical data

Order no.	032-1CD30
Type	SM 032 - Analog output
Module ID	0509 2560
<b>Current consumption/power loss</b>	
Current consumption from backplane bus	65 mA
Current consumption from load voltage L+ (without load)	20 mA
Power loss	0.8 W
<b>Technical data analog outputs</b>	
Number of outputs	4
Cable length, shielded	200 m
Rated load voltage	DC 24 V
Reverse polarity protection of rated load voltage	✓
Current consumption from rated load voltage	-
Voltage output short-circuit protection	✓
Voltage outputs	✓
Min. load resistance (voltage range)	5 kΩ
Max. capacitive load (current range)	1 μF
Max. inductive load (current range)	10 mA
Output voltage ranges	0 V ... +10 V
Operational limit of voltage ranges	+/-0.2%
Basic error limit voltage ranges	+/-0.1%
Destruction limit against external applied voltage	max. 24V
Current outputs	-
Max. in load resistance (current range)	-
Max. inductive load (current range)	-
Typ. open circuit voltage current output	-
Output current ranges	-
Operational limit of current ranges	-
Basic error limit current ranges	-
Destruction limit against external applied voltage	-
Settling time for ohmic load	150 μs
Settling time for capacitive load	1 ms
Settling time for inductive load	-
Resolution in bit	16
Conversion time	200 μs all channels
Substitute value can be applied	no
Output data size	8 Byte
<b>Status information, alarms, diagnostics</b>	

Order no.	032-1CD30
Status display	yes
Interrupts	no
Process alarm	no
Diagnostic interrupt	no
Diagnostic functions	yes
Diagnostics information read-out	possible
Supply voltage display	green LED
Group error display	red LED
Channel error display	red LED per channel
<b>Isolation</b>	
Between channels	-
Between channels of groups to	-
Between channels and backplane bus	✓
Between channels and power supply	✓
Max. potential difference between circuits	-
Max. potential difference between inputs (U <sub>cm</sub> )	-
Max. potential difference between Mana and Mintern (U <sub>iso</sub> )	DC 75 V/ AC 50 V
Max. potential difference between inputs and Mana (U <sub>cm</sub> )	-
Max. potential difference between inputs and Mintern (U <sub>iso</sub> )	-
Max. potential difference between Mintern and outputs	-
Insulation tested with	DC 500 V
<b>Datasizes</b>	
Input bytes	0
Output bytes	8
Parameter bytes	10
Diagnostic bytes	20
<b>Housing</b>	
Material	PPE / PPE GF10
Mounting	Profile rail 35 mm
<b>Mechanical data</b>	
Dimensions (WxHxD)	12.9 mm x 109 mm x 76.5 mm
Net weight	60 g
Weight including accessories	60 g
Gross weight	75 g
<b>Environmental conditions</b>	
Operating temperature	0 °C to 60 °C

032-1CD30 - AO 4x16Bit 0...10V &gt; Parameter data

<b>Order no.</b>	<b>032-1CD30</b>
Storage temperature	-25 °C to 70 °C
<b>Certifications</b>	
UL certification	yes
KC certification	yes
UKCA certification	yes
ChinaRoHS certification	yes

#### 4.13.2 Parameter data

- DS Record set for access via CPU, PROFIBUS and PROFINET  
 IX Index for access via CANopen  
 SX Subindex for access via EtherCAT with Index 3100h + EtherCAT-Slot  
 More can be found in the according manual of your bus coupler.

Name	Bytes	Function	Default	DS	IX	SX
RES0	1	reserved	00h	00h	3100h	01h
SHORT_EN	1	Short-circuit recognition	00h	00h	3101h	02h
CH0FN	1	Function number channel 0	10h	80h	3102h	03h
CH1FN	1	Function number channel 1	10h	81h	3103h	04h
CH2FN	1	Function number channel 2	10h	82h	3104h	05h
CH3FN	1	Function number channel 3	10h	83h	3105h	06h

#### SHORT\_EN Short-circuit recognition

Byte	Bit 7 ... 0
0	<ul style="list-style-type: none"> <li>■ Bit 0: Short-circuit recognition channel 0 (1:on)</li> <li>■ Bit 1: Short-circuit recognition channel 1 (1:on)</li> <li>■ Bit 2: Short-circuit recognition channel 2 (1:on)</li> <li>■ Bit 3: Short-circuit recognition channel 3 (1:on)</li> <li>■ Bit 7 ... 4: reserved</li> </ul>

#### CHxFN Function number channel x

In the following there are the measuring ranges with corresponding function number listed, which were supported by the analog module. With FFh the corresponding channel is deactivated. The formulas listed here allow you to transform an evaluated measuring value (digital value) to a value assigned to the measuring range (analog value) and vice versa.

Output range voltage 0 ... 10V (funct. no.)	Voltage (U)	Decimal (D)	Hex	Range	Formulas
0 ... 10V Siemens S7 format (10h)	11.76V	32511	7EFFh	overrange	$U = D \times \frac{10}{27648}$ $D = 27648 \times \frac{U}{10}$
	10V	27648	6C00h	nominal range	
	5V	13824	3600h		
	0V	0	0000h		
	Not possible, is limited to 0V.				
0 ... 10V Siemens S5 format (20h)	12.5V	20480	5000h	overrange	$U = D \times \frac{10}{16384}$ $D = 16384 \times \frac{U}{10}$
	10V	16384	4000h	nominal range	
	5V	8192	2000h		
	0V	0	0000h		
	Not possible, is limited to 0V.				

### 4.13.3 Diagnostic data

So this module does not support diagnostic interrupt functions, the diagnostics data serve for information about this module. On error the corresponding channel LED of the module is activated and the error is registered in the diagnostics data.

The following errors are listed in the diagnostics data:

- Error in project engineering / parameterization
- Short-circuit/overload (if parameterized)

DS Record set for access via CPU, PROFIBUS and PROFINET. The access happens by DS 01h. Additionally the first 4 bytes may be accessed by DS 00h.

IX Index for access via CANopen. The access happens by IX 2F01h. Additionally the first 4 bytes may be accessed by IX 2F00h.

SX Subindex for access via EtherCAT with Index 5005h.

More can be found in the according manual of your bus coupler.

032-1CD30 - AO 4x16Bit 0...10V &gt; Diagnostic data

Name	Bytes	Function	Default	DS	IX	SX
ERR_A	1	Diagnostic	00h	01h	2F01h	02h
MODTYP	1	Module information	15h			03h
ERR_C	1	reserved	00h			04h
ERR_D	1	Diagnostic	00h			05h
CHTYP	1	Channel type	73h			06h
NUMBIT	1	Number diagnostic bits per channel	08h			07h
NUMCH	1	Number of channels of a module	04h			08h
CHERR	1	Channel error	00h			09h
CH0ERR	1	Channel-specific error channel 0	00h			0Ah
CH1ERR	1	Channel-specific error channel 1	00h			0Bh
CH2ERR	1	Channel-specific error channel 2	00h			0Ch
CH3ERR	1	Channel-specific error channel 3	00h			0Dh
CH4ERR... CH7ERR	4	reserved	00h			0Eh ... 11h
DIAG_US	4	µs ticker	00h			13h

**ERR\_A Diagnostic**

Byte	Bit 7 ... 0
0	<ul style="list-style-type: none"> <li>■ Bit 0: set at module failure</li> <li>■ Bit 1: set at internal error</li> <li>■ Bit 2: set at external error</li> <li>■ Bit 3: set at channel error</li> <li>■ Bit 4: set at external auxiliary supply missing</li> <li>■ Bit 6 ... 5: reserved</li> <li>■ Bit 7: set at error in parametrization</li> </ul>

**MODTYP  
Module information**

Byte	Bit 7 ... 0
0	<ul style="list-style-type: none"> <li>■ Bit 3 ... 0: module class <ul style="list-style-type: none"> <li>– 0101b analog module</li> </ul> </li> <li>■ Bit 4: set at channel information present</li> <li>■ Bit 7 ... 5: reserved</li> </ul>

**ERR\_D Diagnostic**

Byte	Bit 7 ... 0
0	<ul style="list-style-type: none"> <li>■ Bit 2 ... 0: reserved</li> <li>■ Bit 3: set at internal diagnostics buffer overflow</li> <li>■ Bit 4: set at internal communication error</li> <li>■ Bit 7 ... 5: reserved</li> </ul>

**CHTYP Channel type**

Byte	Bit 7 ... 0
0	<ul style="list-style-type: none"> <li>■ Bit 6 ... 0: Channel type               <ul style="list-style-type: none"> <li>- 70h: Digital input</li> <li>- 71h: Analog input</li> <li>- 72h: Digital output</li> <li>- 73h: Analog output</li> <li>- 74h: Analog input/-output</li> <li>- 76h: Counter</li> </ul> </li> <li>■ Bit 7: reserved</li> </ul>

**NUMBIT Diagnostic bits**

Byte	Bit 7 ... 0
0	Number of diagnostic bits per channel (here 08h)

**NUMCH Channels**

Byte	Bit 7 ... 0
0	Number of channels of a module (here 04h)

**CHERR Channel error**

Byte	Bit 7 ... 0
0	<ul style="list-style-type: none"> <li>■ Bit 0: set at error in channel group 0</li> <li>■ Bit 1: set at error in channel group 1</li> <li>■ Bit 2: set at error in channel group 2</li> <li>■ Bit 3: set at error in channel group 3</li> <li>■ Bit 7 ... 4: reserved</li> </ul>

**CH0ERR ... CH3ERR  
Channel-specific**

Byte	Bit 7 ... 0
0	Channel-specific error channel x: <ul style="list-style-type: none"> <li>■ Bit 0: set at configuring/parameter assignment error</li> <li>■ Bit 2 ... 1: reserved</li> <li>■ Bit 3: set at short-circuit to ground</li> <li>■ Bit 7 ... 4: reserved</li> </ul>

**CH4ERR ... CH7ERR  
reserved**

Byte	Bit 7 ... 0
0	reserved

**DIAG\_US  $\mu$ s ticker**

Byte	Bit 7 ... 0
0...3	Value of the $\mu$ s ticker at the moment of the diagnostic

 *$\mu$ s ticker*

In the System SLIO module there is a timer ( $\mu$ s ticker). With PowerON the timer starts counting with 0. After  $2^{32}-1\mu$ s the timer starts with 0 again.

032-1CD40 - AO 4x16Bit 0(4)...20mA

### 4.14 032-1CD40 - AO 4x16Bit 0(4)...20mA

#### Properties

The electronic module has 4 outputs with parameterizable functions. The channels of the module are electrically isolated from the backplane bus. In addition, the channels are isolated to the DC 24V power supply by means of DC/DC converter.

- 4 analog outputs
- Suited for sensors with 0...20mA; 4...20mA
- Diagnostics function
- 16bit resolution

#### Structure

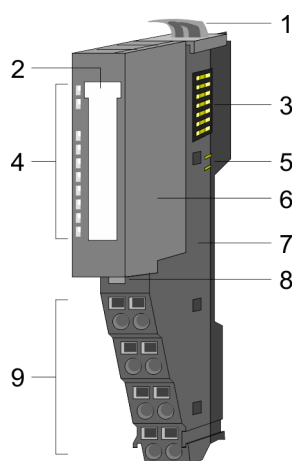

- 1 Locking lever terminal module
- 2 Labeling strip
- 3 Backplane bus
- 4 LED status indication
- 5 DC 24V power section supply
- 6 Electronic module
- 7 Terminal module
- 8 Locking lever electronic module
- 9 Terminal

#### Status indication

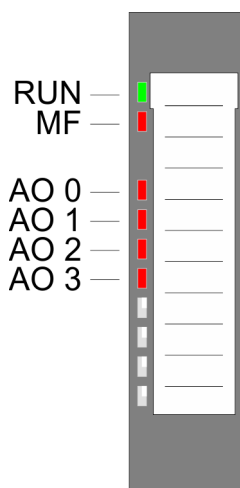

RUN	MF	AO x	Description
<input checked="" type="checkbox"/> green	<input checked="" type="checkbox"/> red	<input checked="" type="checkbox"/> red	
<input checked="" type="checkbox"/>	<input type="checkbox"/>	X	Bus communication is OK Module status is OK
<input checked="" type="checkbox"/>	<input checked="" type="checkbox"/>	X	Bus communication is OK Module status reports an error
<input type="checkbox"/>	<input checked="" type="checkbox"/>	X	Bus communication is not possible Module status reports an error
<input type="checkbox"/>	<input type="checkbox"/>	X	Error at bus power supply
X	<input checked="" type="checkbox"/>	X	Error in configuration → <a href="#">‘Trouble shooting - LEDs’...page 41</a>
<input checked="" type="checkbox"/>	<input type="checkbox"/>	<input checked="" type="checkbox"/>	Error channel x <ul style="list-style-type: none"> <li>■ Error in parameterization</li> <li>■ Wire break (if parameterized)</li> </ul>
not relevant: X			



**Pin assignment**

For wires with a cross section of 0.08mm<sup>2</sup> up to 1.5mm<sup>2</sup>.

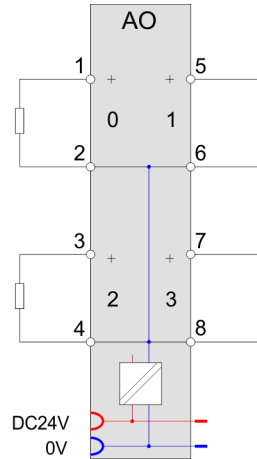
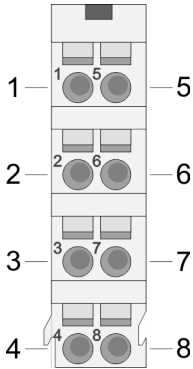

Pos.	Function	Type	Description
1	AO 0	O	Channel 0
2	AGND	O	Ground channels
3	AO 2	O	Channel 2
4	AGND	O	Ground channels
5	AO 1	O	Channel 1
6	AGND	O	Ground channels
7	AO 3	O	Channel 3
8	AGND	O	Ground channels

O: Output

**Input area**

No byte of the input area is used by the module.

**Output area**

At CPU, PROFIBUS and PROFINET the output area is embedded to the corresponding address area.

IX Index for access via CANopen with s = Subindex, depends on number and type of analog modules

SX Subindex for access via EtherCAT with Index 7000h + EtherCAT-Slot

More can be found in the according manual of your bus coupler.

Addr.	Name	Bytes	Function	IX	SX
+0	AO 0	2	Analog value channel 0	6411h/s	01h
+2	AO 1	2	Analog value channel 1	6411h/s+1	02h
+4	AO 2	2	Analog value channel 2	6411h/s+2	03h
+6	AO 3	2	Analog value channel 3	6411h/s+3	04h

## 4.14.1 Technical data

Order no.	032-1CD40
Type	SM 032 - Analog output
Module ID	050C 25E0
<b>Current consumption/power loss</b>	
Current consumption from backplane bus	65 mA
Current consumption from load voltage L+ (without load)	20 mA
Power loss	0.8 W
<b>Technical data analog outputs</b>	
Number of outputs	4
Cable length, shielded	200 m
Rated load voltage	DC 24 V
Reverse polarity protection of rated load voltage	✓
Current consumption from rated load voltage	-
Voltage output short-circuit protection	-
Voltage outputs	-
Min. load resistance (voltage range)	-
Max. capacitive load (current range)	-
Max. inductive load (current range)	-
Output voltage ranges	-
Operational limit of voltage ranges	-
Basic error limit voltage ranges	-
Destruction limit against external applied voltage	-
Current outputs	✓
Max. in load resistance (current range)	350 Ω
Max. inductive load (current range)	10 mH
Typ. open circuit voltage current output	12 V
Output current ranges	0 mA ... +20 mA +4 mA ... +20 mA
Operational limit of current ranges	+/-0.2%
Basic error limit current ranges	+/-0.1%
Destruction limit against external applied voltage	max. 12V (30V for 1s)
Settling time for ohmic load	0.25 ms
Settling time for capacitive load	-
Settling time for inductive load	1.5 ms
Resolution in bit	16
Conversion time	400 μs all channels
Substitute value can be applied	no
Output data size	8 Byte

Order no.	032-1CD40
<b>Status information, alarms, diagnostics</b>	
Status display	yes
Interrupts	no
Process alarm	no
Diagnostic interrupt	no
Diagnostic functions	yes
Diagnostics information read-out	possible
Supply voltage display	green LED
Group error display	red LED
Channel error display	red LED per channel
<b>Isolation</b>	
Between channels	-
Between channels of groups to	-
Between channels and backplane bus	✓
Between channels and power supply	✓
Max. potential difference between circuits	-
Max. potential difference between inputs (U <sub>cm</sub> )	-
Max. potential difference between Mana and Mintern (U <sub>iso</sub> )	DC 75 V/ AC 50 V
Max. potential difference between inputs and Mana (U <sub>cm</sub> )	-
Max. potential difference between inputs and Mintern (U <sub>iso</sub> )	-
Max. potential difference between Mintern and outputs	-
Insulation tested with	DC 500 V
<b>Datasizes</b>	
Input bytes	0
Output bytes	8
Parameter bytes	10
Diagnostic bytes	20
<b>Housing</b>	
Material	PPE / PPE GF10
Mounting	Profile rail 35 mm
<b>Mechanical data</b>	
Dimensions (WxHxD)	12.9 mm x 109 mm x 76.5 mm
Net weight	61 g
Weight including accessories	61 g
Gross weight	75 g
<b>Environmental conditions</b>	

032-1CD40 - AO 4x16Bit 0(4)...20mA &gt; Parameter data

<b>Order no.</b>	<b>032-1CD40</b>
Operating temperature	0 °C to 60 °C
Storage temperature	-25 °C to 70 °C
<b>Certifications</b>	
UL certification	yes
KC certification	yes
UKCA certification	yes
ChinaRoHS certification	yes

#### 4.14.2 Parameter data

DS Record set for access via CPU, PROFIBUS and PROFINET

IX Index for access via CANopen

SX Subindex for access via EtherCAT with Index 3100h + EtherCAT-Slot

More can be found in the according manual of your bus coupler.

Name	Bytes	Function	Default	DS	IX	SX
RES0	1	reserved	00h	00h	3100h	01h
WIBRK_EN	1	Wire-break recognition	00h	00h	3101h	02h
CH0FN	1	Function number channel 0	31h	80h	3102h	03h
CH1FN	1	Function number channel 1	31h	81h	3103h	04h
CH2FN	1	Function number channel 2	31h	82h	3104h	05h
CH3FN	1	Function number channel 3	31h	83h	3105h	06h

#### WIBRK\_EN Wire-break recognition

Byte	Bit 7 ... 0
0	<ul style="list-style-type: none"> <li>■ Bit 0: Wire-break recognition channel 0 (1: on)</li> <li>■ Bit 1: Wire-break recognition channel 1 (1: on)</li> <li>■ Bit 2: Wire-break recognition channel 2 (1: on)</li> <li>■ Bit 3: Wire-break recognition channel 3 (1: on)</li> <li>■ Bit 7 ... 4: reserved</li> </ul>



*Please consider with enabled wire break recognition with the output range 0 ... 20mA, when the current goes below of 40µA (100 Digits), this can may lead to sporadic wire break messages!*

#### CHxFN Function number channel x

In the following there are the measuring ranges with corresponding function number listed, which were supported by the analog module. With FFh the corresponding channel is deactivated. The formulas listed here allow you to transform an evaluated measuring value (digital value) to a value assigned to the measuring range (analog value) and vice versa.

Output range current 0 ... 20mA (funct. no.)	Current (I)	Decimal (D)	Hex	Range	Formulas
0 ... 20mA Siemens S7 format (31h)	23.52mA	32511	7EFFh	overrange	$I = D \times \frac{20}{27648}$ $D = 27648 \times \frac{I}{20}$
	20mA	27648	6C00h	nominal range	
	10mA	13824	3600h		
	0mA	0	0000h		
	Not possible, is limited to 0mA.			underrange	
0 ... 20mA Siemens S5 format (41h)	25.00mA	20480	5000h	overrange	$I = D \times \frac{20}{16384}$ $D = 16384 \times \frac{I}{20}$
	20mA	16384	4000h	nominal range	
	10mA	8192	2000h		
	0mA	0	0000h		
	Not possible, is limited to 0mA.			underrange	

Output range current 4 ... 20mA (funct. no.)	Current (I)	Decimal (D)	Hex	Range	Formulas
4 ... 20mA Siemens S7 format (30h)	22.81mA	32511	7EFFh	overrange	$I = D \times \frac{16}{27648} + 4$ $D = 27648 \times \frac{I-4}{16}$
	20mA	27648	6C00h	nominal range	
	12mA	13824	3600h		
	4mA	0	0000h		
	0mA	-6912	E500h	underrange	
4 ... 20mA Siemens S5 format (40h)	24.00mA	20480	5000h	overrange	$I = D \times \frac{16}{16384} + 4$ $D = 16384 \times \frac{I-4}{16}$
	20mA	16384	4000h	nominal range	
	12mA	8192	2000h		
	4mA	0	0000h		
	0mA	-4096	F000h	underrange	

### 4.14.3 Diagnostic data

So this module does not support interrupt functions, the diagnostics data serve for information about this module. On error the corresponding channel LED of the module is activated and the error is registered in the diagnostics data.

The following errors are listed in the diagnostics data:

- Error in project engineering / parameterization
- Wire-break (if parameterized)

032-1CD40 - AO 4x16Bit 0(4)...20mA &gt; Diagnostic data

- DS Record set for access via CPU, PROFIBUS and PROFINET. The access happens by DS 01h. Additionally the first 4 bytes may be accessed by DS 00h.
- IX Index for access via CANopen. The access happens by IX 2F01h. Additionally the first 4 bytes may be accessed by IX 2F00h.
- SX Subindex for access via EtherCAT with Index 5005h.
- More can be found in the according manual of your bus coupler.

Name	Bytes	Function	Default	DS	IX	SX
ERR_A	1	Diagnostic	00h	01h	2F01h	02h
MODTYP	1	Module information	15h			03h
ERR_C	1	reserved	00h			04h
ERR_D	1	Diagnostic	00h			05h
CHTYP	1	Channel type	73h			06h
NUMBIT	1	Number diagnostic bits per channel	08h			07h
NUMCH	1	Number of channels of a module	04h			08h
CHERR	1	Channel error	00h			09h
CH0ERR	1	Channel-specific error channel 0	00h			0Ah
CH1ERR	1	Channel-specific error channel 1	00h			0Bh
CH2ERR	1	Channel-specific error channel 2	00h			0Ch
CH3ERR	1	Channel-specific error channel 3	00h			0Dh
CH4ERR... CH7ERR	4	reserved	00h			0Eh ... 11h
DIAG_US	4	µs ticker	00h			13h

**ERR\_A Diagnostic**

Byte	Bit 7 ... 0
0	<ul style="list-style-type: none"> <li>■ Bit 0: set at module failure</li> <li>■ Bit 1: set at internal error</li> <li>■ Bit 2: set at external error</li> <li>■ Bit 3: set at channel error</li> <li>■ Bit 4: set at external auxiliary supply missing</li> <li>■ Bit 6 ... 5: reserved</li> <li>■ Bit 7: set at error in parametrization</li> </ul>

**MODTYP  
Module information**

Byte	Bit 7 ... 0
0	<ul style="list-style-type: none"> <li>■ Bit 3 ... 0: module class <ul style="list-style-type: none"> <li>- 0101b analog module</li> </ul> </li> <li>■ Bit 4: set at channel information present</li> <li>■ Bit 7 ... 5: reserved</li> </ul>

**ERR\_D Diagnostic**

Byte	Bit 7 ... 0
0	<ul style="list-style-type: none"> <li>■ Bit 2 ... 0: reserved</li> <li>■ Bit 3: set at internal diagnostics buffer overflow</li> <li>■ Bit 4: set at internal communication error</li> <li>■ Bit 7 ... 5: reserved</li> </ul>

**CHTYP Channel type**

Byte	Bit 7 ... 0
0	<ul style="list-style-type: none"> <li>■ Bit 6 ... 0: Channel type <ul style="list-style-type: none"> <li>- 70h: Digital input</li> <li>- 71h: Analog input</li> <li>- 72h: Digital output</li> <li>- 73h: Analog output</li> <li>- 74h: Analog input/-output</li> <li>- 76h: Counter</li> </ul> </li> <li>■ Bit 7: reserved</li> </ul>

**NUMBIT Diagnostic bits**

Byte	Bit 7 ... 0
0	Number of diagnostic bits per channel (here 08h)

**NUMCH Channels**

Byte	Bit 7 ... 0
0	Number of channels of a module (here 04h)

**CHERR Channel error**

Byte	Bit 7 ... 0
0	<ul style="list-style-type: none"> <li>■ Bit 0: set at error in channel group 0</li> <li>■ Bit 1: set at error in channel group 1</li> <li>■ Bit 2: set at error in channel group 2</li> <li>■ Bit 3: set at error in channel group 3</li> <li>■ Bit 7 ... 4: reserved</li> </ul>

**CH0ERR ... CH3ERR  
Channel-specific**

Byte	Bit 7 ... 0
0	Channel-specific error channel x: <ul style="list-style-type: none"> <li>■ Bit 0: set at configuring/parameter assignment error</li> <li>■ Bit 3 ... 1: reserved</li> <li>■ Bit 4: set at wire-break</li> <li>■ Bit 7 ... 5: reserved</li> </ul>

032-1CD40 - AO 4x16Bit 0(4)...20mA > Diagnostic data

**DIAG\_US  $\mu$ s ticker**

Byte	Bit 7 ... 0
0...3	Value of the $\mu$ s ticker at the moment of the diagnostic

 *$\mu$ s ticker*

In the System SLIO module there is a timer ( $\mu$ s ticker). With PowerON the timer starts counting with 0. After  $2^{32}-1\mu$ s the timer starts with 0 again.



### 4.15 032-1CD70 - AO 4x16Bit ±10V

**Properties**

The electronic module has 4 outputs with parameterizable functions. The channels of the module are electrically isolated from the backplane bus. In addition, the channels are isolated to the DC 24V power supply by means of DC/DC converter.

- 4 analog outputs
- Suited for sensors with ±10V, 0 ... 10V
- Diagnostics function
- 16bit resolution

**Structure**

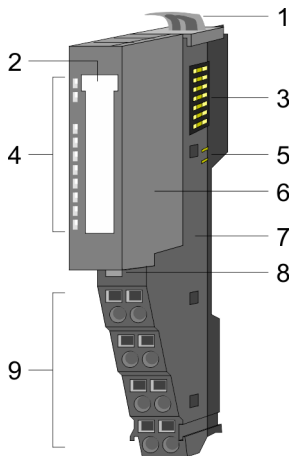

- 1 Locking lever terminal module
- 2 Labeling strip
- 3 Backplane bus
- 4 LED status indication
- 5 DC 24V power section supply
- 6 Electronic module
- 7 Terminal module
- 8 Locking lever electronic module
- 9 Terminal

**Status indication**

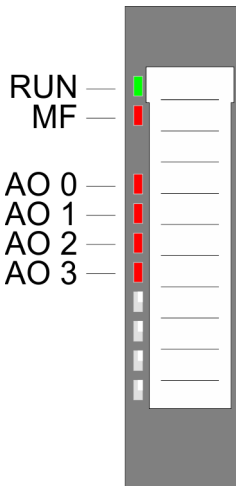

RUN	MF	AO x	Description
<input checked="" type="checkbox"/> green	<input checked="" type="checkbox"/> red	<input checked="" type="checkbox"/> red	
<input checked="" type="checkbox"/>	<input type="checkbox"/>	X	Bus communication is OK Module status is OK
<input checked="" type="checkbox"/>	<input checked="" type="checkbox"/>	X	Bus communication is OK Module status reports an error
<input type="checkbox"/>	<input checked="" type="checkbox"/>	X	Bus communication is not possible Module status reports an error
<input type="checkbox"/>	<input type="checkbox"/>	X	Error at bus power supply
X	<input checked="" type="checkbox"/>	X	Error in configuration → <a href="#">‘Trouble shooting - LEDs’...page 41</a>
<input checked="" type="checkbox"/>	<input type="checkbox"/>	<input checked="" type="checkbox"/>	Error channel x <ul style="list-style-type: none"> <li>■ Overload, short-circuit</li> <li>■ Error in parameterization</li> </ul>
not relevant: X			

032-1CD70 - AO 4x16Bit ±10V

**Pin assignment**

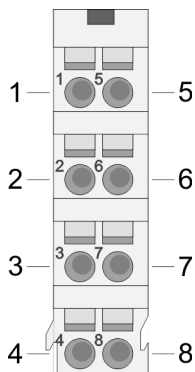

For wires with a cross section of 0.08mm<sup>2</sup> up to 1.5mm<sup>2</sup>.

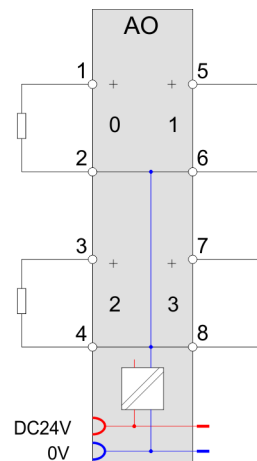

Pos.	Function	Type	Description
1	AO 0	O	Channel 0
2	AGND	O	Ground channels
3	AO 2	O	Channel 2
4	AGND	O	Ground channels
5	AO 1	O	Channel 1
6	AGND	O	Ground channels
7	AO 3	O	Channel 3
8	AGND	O	Ground channels

O: Output

**Input area**

No byte of the input area is used by the module.

**Output area**

At CPU, PROFIBUS and PROFINET the output area is embedded to the corresponding address area.

IX Index for access via CANopen with s = Subindex, depends on number and type of analog modules

SX Subindex for access via EtherCAT with Index 7000h + EtherCAT-Slot

More can be found in the according manual of your bus coupler.

Addr.	Name	Bytes	Function	IX	SX
+0	AO 0	2	Analog value channel 0	6411h/s	01h
+2	AO 1	2	Analog value channel 1	6411h/s+1	02h
+4	AO 2	2	Analog value channel 2	6411h/s+2	03h
+6	AO 3	2	Analog value channel 3	6411h/s+3	04h

## 4.15.1 Technical data

<b>Order no.</b>	<b>032-1CD70</b>
Type	SM 032 - Analog output
Module ID	050A 25E0
<b>Current consumption/power loss</b>	
Current consumption from backplane bus	65 mA
Current consumption from load voltage L+ (without load)	20 mA
Power loss	0.8 W
<b>Technical data analog outputs</b>	
Number of outputs	4
Cable length, shielded	200 m
Rated load voltage	DC 24 V
Reverse polarity protection of rated load voltage	✓
Current consumption from rated load voltage	-
Voltage output short-circuit protection	✓
Voltage outputs	✓
Min. load resistance (voltage range)	5 k $\Omega$
Max. capacitive load (current range)	1 $\mu$ F
Max. inductive load (current range)	10 mA
Output voltage ranges	-10 V ... +10 V 0 V ... +10 V
Operational limit of voltage ranges	+/-0.2%
Basic error limit voltage ranges	+/-0.1%
Destruction limit against external applied voltage	max. 24V
Current outputs	-
Max. in load resistance (current range)	-
Max. inductive load (current range)	-
Typ. open circuit voltage current output	-
Output current ranges	-
Operational limit of current ranges	-
Basic error limit current ranges	-
Destruction limit against external applied voltage	-
Settling time for ohmic load	300 $\mu$ s
Settling time for capacitive load	3 ms
Settling time for inductive load	-
Resolution in bit	16
Conversion time	200 $\mu$ s all channels
Substitute value can be applied	no
Output data size	8 Byte

032-1CD70 - AO 4x16Bit  $\pm 10V$  > Technical data

Order no.	032-1CD70
<b>Status information, alarms, diagnostics</b>	
Status display	yes
Interrupts	no
Process alarm	no
Diagnostic interrupt	no
Diagnostic functions	yes
Diagnostics information read-out	possible
Supply voltage display	green LED
Group error display	red LED
Channel error display	red LED per channel
<b>Isolation</b>	
Between channels	-
Between channels of groups to	-
Between channels and backplane bus	✓
Between channels and power supply	✓
Max. potential difference between circuits	-
Max. potential difference between inputs (Ucm)	-
Max. potential difference between Mana and Mintern (Uiso)	DC 75 V/ AC 50 V
Max. potential difference between inputs and Mana (Ucm)	-
Max. potential difference between inputs and Mintern (Uiso)	-
Max. potential difference between Mintern and outputs	-
Insulation tested with	DC 500 V
<b>Datasizes</b>	
Input bytes	0
Output bytes	8
Parameter bytes	10
Diagnostic bytes	20
<b>Housing</b>	
Material	PPE / PPE GF10
Mounting	Profile rail 35 mm
<b>Mechanical data</b>	
Dimensions (WxHxD)	12.9 mm x 109 mm x 76.5 mm
Net weight	61 g
Weight including accessories	61 g
Gross weight	75 g
<b>Environmental conditions</b>	

<b>Order no.</b>	<b>032-1CD70</b>
Operating temperature	0 °C to 60 °C
Storage temperature	-25 °C to 70 °C
<b>Certifications</b>	
UL certification	yes
KC certification	yes
UKCA certification	yes
ChinaRoHS certification	yes

#### 4.15.2 Parameter data

DS Record set for access via CPU, PROFIBUS and PROFINET

IX Index for access via CANopen

SX Subindex for access via EtherCAT with Index 3100h + EtherCAT-Slot

More can be found in the according manual of your bus coupler.

Name	Bytes	Function	Default	DS	IX	SX
RES0	1	reserved	00h	00h	3100h	01h
SHORT_EN	1	Short-circuit recognition	00h	00h	3101h	02h
CH0FN	1	Function number channel 0	12h	80h	3102h	03h
CH1FN	1	Function number channel 1	12h	81h	3103h	04h
CH2FN	1	Function number channel 2	12h	82h	3104h	05h
CH3FN	1	Function number channel 3	12h	83h	3105h	06h

#### SHORT\_EN Short-circuit recognition

Byte	Bit 7 ... 0
0	<ul style="list-style-type: none"> <li>■ Bit 0: Short-circuit recognition channel 0 (1:on)</li> <li>■ Bit 1: Short-circuit recognition channel 1 (1:on)</li> <li>■ Bit 2: Short-circuit recognition channel 2 (1:on)</li> <li>■ Bit 3: Short-circuit recognition channel 3 (1:on)</li> <li>■ Bit 7 ... 4: reserved</li> </ul>

#### CHxFN Function number channel x

In the following there are the measuring ranges with corresponding function number listed, which were supported by the analog module. With FFh the corresponding channel is deactivated. The formulas listed here allow you to transform an evaluated measuring value (digital value) to a value assigned to the measuring range (analog value) and vice versa.

032-1CD70 - AO 4x16Bit ±10V &gt; Diagnostic data

Output range voltage ±10V (funct. no.)	Voltage (U)	Decimal (D)	Hex	Range	Formulas
±10V Siemens S7 format (12h)	11.76V	32511	7EFFh	overrange	$U = D \times \frac{10}{27648}$ $D = 27648 \times \frac{U}{10}$
	10V	27648	6C00h	nominal range	
	5V	13824	3600h		
	0V	0	0000h		
	-5V	-13824	CA00h		
	-10V	-27648	9400h		
	-11.76V	-32512	8100h	underrange	
±10V Siemens S5 format (22h)	12.5V	20480	5000h	overrange	$U = D \times \frac{10}{16384}$ $D = 16384 \times \frac{U}{10}$
	10V	16384	4000h	nominal range	
	5V	8192	2000h		
	0V	0	0000h		
	-5V	-8192	E000h		
	-10V	-16384	C000h		
	-12.5V	-20480	B000h	underrange	

Output range voltage 0 ... 10V (funct. no.)	Voltage (U)	Decimal (D)	Hex	Range	Formulas
0 ... 10V Siemens S7 format (10h)	11.76V	32511	7EFFh	overrange	$U = D \times \frac{10}{27648}$ $D = 27648 \times \frac{U}{10}$
	10V	27648	6C00h	nominal range	
	5V	13824	3600h		
	0V	0	0000h		
	Not possible, is limited to 0V.				
0 ... 10V Siemens S5 format (20h)	12.5V	20480	5000h	overrange	$U = D \times \frac{10}{16384}$ $D = 16384 \times \frac{U}{10}$
	10V	16384	4000h	nominal range	
	5V	8192	2000h		
	0V	0	0000h		
	Not possible, is limited to 0V.				

### 4.15.3 Diagnostic data

So this module does not support diagnostic interrupt functions, the diagnostics data serve for information about this module. On error the corresponding channel LED of the module is activated and the error is registered in the diagnostics data.

The following errors are listed in the diagnostics data:

- Error in project engineering / parameterization
- Short-circuit/overload (if parameterized)

- DS Record set for access via CPU, PROFIBUS and PROFINET. The access happens by DS 01h. Additionally the first 4 bytes may be accessed by DS 00h.
  - IX Index for access via CANopen. The access happens by IX 2F01h. Additionally the first 4 bytes may be accessed by IX 2F00h.
  - SX Subindex for access via EtherCAT with Index 5005h.
- More can be found in the according manual of your bus coupler.

Name	Bytes	Function	Default	DS	IX	SX
ERR_A	1	Diagnostic	00h	01h	2F01h	02h
MODTYP	1	Module information	15h			03h
ERR_C	1	reserved	00h			04h
ERR_D	1	Diagnostic	00h			05h
CHTYP	1	Channel type	73h			06h
NUMBIT	1	Number diagnostic bits per channel	08h			07h
NUMCH	1	Number of channels of a module	04h			08h
CHERR	1	Channel error	00h			09h
CH0ERR	1	Channel-specific error channel 0	00h			0Ah
CH1ERR	1	Channel-specific error channel 1	00h			0Bh
CH2ERR	1	Channel-specific error channel 2	00h			0Ch
CH3ERR	1	Channel-specific error channel 3	00h			0Dh
CH4ERR... CH7ERR	4	reserved	00h			0Eh ... 11h
DIAG_US	4	µs ticker	00h			13h

**ERR\_A Diagnostic**

Byte	Bit 7 ... 0
0	<ul style="list-style-type: none"> <li>■ Bit 0: set at module failure</li> <li>■ Bit 1: set at internal error</li> <li>■ Bit 2: set at external error</li> <li>■ Bit 3: set at channel error</li> <li>■ Bit 4: set at external auxiliary supply missing</li> <li>■ Bit 6 ... 5: reserved</li> <li>■ Bit 7: set at error in parametrization</li> </ul>

**MODTYP  
Module information**

Byte	Bit 7 ... 0
0	<ul style="list-style-type: none"> <li>■ Bit 3 ... 0: module class                             <ul style="list-style-type: none"> <li>- 0101b analog module</li> </ul> </li> <li>■ Bit 4: set at channel information present</li> <li>■ Bit 7 ... 5: reserved</li> </ul>

032-1CD70 - AO 4x16Bit ±10V &gt; Diagnostic data

**ERR\_D Diagnostic**

Byte	Bit 7 ... 0
0	<ul style="list-style-type: none"> <li>■ Bit 2 ... 0: reserved</li> <li>■ Bit 3: set at internal diagnostics buffer overflow</li> <li>■ Bit 4: set at internal communication error</li> <li>■ Bit 7 ... 5: reserved</li> </ul>

**CHTYP Channel type**

Byte	Bit 7 ... 0
0	<ul style="list-style-type: none"> <li>■ Bit 6 ... 0: Channel type <ul style="list-style-type: none"> <li>- 70h: Digital input</li> <li>- 71h: Analog input</li> <li>- 72h: Digital output</li> <li>- 73h: Analog output</li> <li>- 74h: Analog input/-output</li> <li>- 76h: Counter</li> </ul> </li> <li>■ Bit 7: reserved</li> </ul>

**NUMBIT Diagnostic bits**

Byte	Bit 7 ... 0
0	Number of diagnostic bits per channel (here 08h)

**NUMCH Channels**

Byte	Bit 7 ... 0
0	Number of channels of a module (here 04h)

**CHERR Channel error**

Byte	Bit 7 ... 0
0	<ul style="list-style-type: none"> <li>■ Bit 0: set at error in channel group 0</li> <li>■ Bit 1: set at error in channel group 1</li> <li>■ Bit 2: set at error in channel group 2</li> <li>■ Bit 3: set at error in channel group 3</li> <li>■ Bit 7 ... 4: reserved</li> </ul>

**CH0ERR ... CH3ERR  
Channel-specific**

Byte	Bit 7 ... 0
0	Channel-specific error channel x: <ul style="list-style-type: none"> <li>■ Bit 0: set at configuring/parameter assignment error</li> <li>■ Bit 2 ... 1: reserved</li> <li>■ Bit 3: set at short-circuit to ground</li> <li>■ Bit 7 ... 4: reserved</li> </ul>

**CH4ERR ... CH7ERR  
reserved**

Byte	Bit 7 ... 0
0	reserved



**DIAG\_US  $\mu s$  ticker**

Byte	Bit 7 ... 0
0...3	Value of the $\mu s$ ticker at the moment of the diagnostic

 **$\mu s$  ticker**

In the System SLIO module there is a timer ( $\mu s$  ticker). With PowerON the timer starts counting with 0. After  $2^{32}-1\mu s$  the timer starts with 0 again.